

City of Bryant Storm Water Management Manual

Prepared by: Clear Creek Engineering, Inc.
1700 Wellington Woods Drive
Little Rock, Arkansas 72211
501-821-1831 (office)
501-821-1831 (fax)

CITY OF BRYANT, ARKANSAS

STORMWATER MANAGEMENT MANUAL

Table of Contents

	<u>Page</u>
SECTION 100 - GENERAL PROVISIONS	2-18
SECTION 200 – DRAINAGE PLANNING AND SUBMITTAL	19-32
SECTION 300 - STORM WATER MANAGEMENT POLICY	33-50
SECTION 400 - STORM WATER RUNOFF	51-88
SECTION 500 - OPEN CHANNEL FLOW	89-126
SECTION 600 - STORM SEWER SYSTEMS	127-151
SECTION 700 - STREET DRAINAGE	152-169
SECTION 800 - STORM INLETS	170-190
SECTION 900 - CULVERTS AND BRIDGES	191-260
SECTION 1000 - DETENTION BASINS	261-281
SECTION 1100 - SEDIMENT AND EROSION CONTROL	282-369

**SECTION 100
GENERAL PROVISIONS**

	<u>Page</u>
100.1 TITLE	3
100.2 JURISDICTION	3
100.3 PURPOSE	3
100.4 ENFORCEMENT RESPONSIBILITY	3
100.5 VARIANCE PROCEDURES	3
100.6 INTERPRETATION	4
100.7 REVIEW AND APPROVAL	4
100.8 IMPLEMENTATION	5
100.9 ACRONYMS AND ABBREVIATIONS	6-8
100.10 GLOSSARY	9-18

SECTION 100 GENERAL PROVISIONS

100.1 TITLE

These criteria and design standards with all future amendments and revisions shall be known as the "CITY OF BRYANT STORMWATER MANAGEMENT MANUAL" (herein referred to as the MANUAL). This MANUAL was adopted by the City of Bryant City Council on _____.

100.2 JURISDICTION

These criteria and design standards shall apply to all areas within the boundaries of The City of Bryant.

100.3 PURPOSE

The purpose of the MANUAL is to provide a minimum standard for analysis, design, construction and management of storm drainage facilities and pollution prevention within The City of Bryant. Adherence to the minimum standard assures that all drainage facilities are consistent in design and construction provides an integrated system, which acts to protect the public health, safety, comfort, convenience, welfare, property and commerce, and assures that construction activities adhere to Best Management Practices that reduce or eliminate erosion, sedimentation and pollutants into waterways of the City.

100.4 ENFORCEMENT RESPONSIBILITY

The City of Bryant Public Works Department (BPWD) is charged with enforcement of the MANUAL within the jurisdictional boundaries of The City of Bryant.

100.5 VARIANCE PROCEDURES

Variances to this MANUAL may only be requested for the following reasons:

1. Unusual situations where strict compliance with the MANUAL may not act to protect the public health and safety.
2. Unusual situations, which require additional analysis outside the scope of this MANUAL for which the additional analysis shows that strict compliance with the MANUAL may not act to protect the public health and safety.
3. Unusual hydrologic and/or hydraulic conditions, which cannot be adequately addressed by strict compliance with the MANUAL.

Conditions which are created by improper site planning (i.e., lack of adequate space allocations) or cost shall not be considered as grounds for a variance request. If the subdivider (developer, builder, etc.) believes that a variance to the

minimum standards in this MANUAL is warranted based on any of the reasons listed above they shall request a variance from the minimum standards in accordance with BPWD variance request procedures.

100.6 INTERPRETATION

In the interpretation and application of the provisions of this MANUAL, the following shall govern:

1. The provisions contained herein shall be regarded as the minimum requirements for the protection of the public health, safety, comfort, convenience, welfare, property, and commerce of the residents of The City of Bryant. This MANUAL shall therefore be regarded as remedial and shall be liberally construed to further its underlying purposes.

2. Whenever a provision of this MANUAL and any other provisions of the REGULATIONS or any provisions in any law, ordinance, resolution, rule, or regulation of any kind, contain any restrictions covering any of the same subject matter, whichever restrictions are more restrictive or impose higher standards of requirements shall govern.

3. The provisions of this ordinance are severable. If any term, requirement or provision of this ordinance or the application thereof to any person or circumstance shall, to any extent, be found invalid or unenforceable, the remainder of this ordinance or the application of such terms, requirements, and provisions to persons or circumstances other than those to which it is held invalid or unenforceable, shall not be affected thereby and each term, requirement, or provision of this ordinance shall be valid and be enforced to the fullest extent permitted by law. The City hereby declares that it would have enacted the remainder of these regulations even without any such part, provision or application found to be unlawful or invalid.

100.7 REVIEW AND APPROVAL

All drainage plans, reports, construction drawings, specifications and other documents as may be required shall be reviewed by BPWD in accordance with the provisions of this MANUAL. This review and approval shall not relieve the owner, engineer, or designer from responsibility of ensuring that the calculations, plans, specifications, and construction drawings are in compliance with the provisions of this MANUAL.

The owner, developer, engineer, and designer must also understand that BPWD does not and will not assume liability for the drainage facilities designed and/or certified by the engineer. In addition, BPWD does not guarantee that drainage design review and approval will absolve the owner, developer, engineer, designer, and/or their successors and/or assigns of future liability for improper design.

100.8 IMPLEMENTATION

100.8.1 Development of the MANUAL

The BPWD has developed this comprehensive MANUAL for use by BPWD, and by consulting engineers. This MANUAL shall be used for the development and design of all stormwater management facilities within all areas of The City of Bryant, both public and private.

100.8.2 Updates

The MANUAL will be updated from time to time as determined by the BPWD Director.

100.8.3 Adoption

The City of Bryant City Council will be the authority responsible for adoption of the MANUAL and all subsequent amendments or updates thereto.

100.8.4 Reconciliation of Pre- and Post-MANUAL Studies

1. Developments, for which final detailed drainage reports or construction drawings that have been submitted to or approved by BPWD prior to the date of adoption of this manual, shall be exempt from the provisions of this MANUAL and/or subsequent amendments, providing such exemption does not violate any other existing codes, ordinances, rules or laws.
2. Developments for which a preliminary drainage analysis has been submitted to or approved by BPWD shall be exempt from the provisions of this MANUAL if a final drainage report and/or analysis is submitted for review within 180 days of the initial adoption of this MANUAL and/or subsequent revisions.
3. Developments for which drainage reports and/or analysis have not been submitted by the time of the initial adoption of this MANUAL shall be reviewed by BPWD in conformance with the provisions of this MANUAL.
4. Developments for which an overall Local Master Drainage Plan has been approved shall be addressed as follows:
 - (a) For new construction affected by facilities designed and constructed (or under construction) at the time of initial MANUAL adoption based on an approved master plan shall be analyzed using flow rates and volumes calculated per the requirements of this MANUAL. If these facilities pass the revised peak flows and volumes within the freeboard limits of the facility, then the facility shall be considered to have adequate capacity. If not, then the owner or developer shall submit a plan which discusses the impact of flows exceeding the capacity of the originally designed system and proposed solutions to minimize these impacts.

100.9 ACRONYMS AND ABBREVIATIONS

The following acronyms and abbreviations are used within the contents of this MANUAL:

A	Area
AASHTO	American Association of State Highway and Transportation Officials
ADEQ	Arkansas Department of Environmental Quality
AHTD	Arkansas Highway and Transportation Department
APA	American Planning Association
ASTM	American Society for Testing and Materials
BFE	Base Flood Elevation
BMP	Best Management Practice(s)
BPAT	Building Performance Assessment Team
CAC	Community Assistance Contact
CAP	Community Assistance Program
CAP	Corrugated Aluminum Pipe
CAPA	Corrugated Aluminum Pipe Arch
CAV	Community Assistance Visit
CEC	Consulting Engineers Council
CFR	Code of Federal Regulations
CFS	Cubic Feet per Second
CLOMA	Conditional Letter of Map Amendment
CLOMR	Conditional Letter of Map Revision
CMP	Corrugated Metal Pipe
CMPA	Corrugated Metal Pipe Arch
CN	Curve Number
CRS	Community Rating System
CSP	Corrugated Steel Pipe
CSPA	Corrugated Steel Pipe Arch
CTP	Cooperative Technical Partners
DFIRM	Digital Flood Insurance Rate Map
DMA	Disaster Mitigation Act of 2000
EGL	Energy Grade Line
EMI	Emergency Management Institute
EO	Executive Order
FAA	Federal Aviation Administration
ft	feet, foot
FEMA	Federal Emergency Management Agency
FES	Flared End Section
FIA	Federal Insurance Administration
FIMA	Federal Insurance and Mitigation Administration
FIRM	Flood Insurance Rate Map
FIS	Flood Insurance Study

FMA	Flood Mitigation Assistance Program
fps	feet per second
GSE	Government Sponsored Enterprise
HDPE	High Density Polyethylene Pipe
HDS	Hydraulic Design Series
HEC	Hydraulic Engineering Circular
HERCP	Horizontal Elliptical Reinforced Concrete Pipe
HGL	Hydraulic Grade Line
HMGP	Hazard Mitigation Grant Program
HOA	Home Owners Association
hr	hour(s)
BPWD	Bryant Public Works Department
HUD	Housing and Urban Development (Dept. of)
ICC	Increased Cost of Compliance
in	inch(es)
LOMA	Letter of Map Amendment
LOMR	Letter of Map Revision
LOMR-F	Letter of Map Revision based on Fill
mi	mile(s)
min	minute(s)
NFIF	National Flood Insurance Fund
NFIP	National Flood Insurance Program
NFIRA	National Flood Insurance Reform Act
NGVD 29	National Geodetic Vertical Datum of 1929
NOAA	National Oceanic and Atmospheric Administration
NPDES	National Pollutant Discharge Elimination System
NWS	National Weather Service
NURP	Nationwide Urban Runoff Program
NRCS	National Resources Conservation Service
NAVD 88	North American Vertical Datum of 1988
OMB	Office of Management and Budget
OPAs	Otherwise Protect Area
PE	Professional Engineer
PMF	Probable Maximum Flood
PMR	Physical Map Revision
RCBAP	Residential Condominium Building Association Policy
RCBC	Reinforced Concrete Box Culvert
RCP	Reinforced Concrete Pipe
ROW	Right-of-Way
SFHA	Special Flood Hazard Area
SFIP	Standard Flood Insurance Policy
SPP	Structural Plate Pipe
SPPA	Structural Plate Pipe Arch
sq mi	square mile(s)

SWPPP	Storm Water Pollution Prevention Plan
TAC	Technical Advisory Committee
tc	time of concentration
ti	initial inlet or overland flow time
tp	time-to-peak
tt	travel time
TB	Technical Bulletin
TRC	Technical Review Committee
USACE	United States Army Corps of Engineers
USCS	Uniform Soil Classification System
USBR	United States Bureau of Reclamation
USEPA	United States Environmental Protection Agency
USGS	United States Geological Survey

100.10 GLOSSARY

The following glossary is provided as an aid in the understanding of some of the terms and abbreviations included in this MANUAL.

1. **Best Management Practices (BMPs)** - Erosion and sediment control and water quality management practices that are the most effective and practicable means of controlling, preventing, and minimizing degradation of surface water, including avoidance of impacts, construction-phasing, minimizing the length of time soil areas are exposed, prohibitions, engineered systems, programs and other management practices published by state or designated area-wide planning agencies.
2. **Bio-retention** – (1) An engineered process to manage stormwater runoff, using the chemical, biological and physical properties afforded by a natural, terrestrial-based community of plants, microbes and soil. Bioretention provides two important functions: water quantity (flood) controls; and improves water quality through removal of pollutants and nutrients associated with runoff. (2) A method used for flow detention by utilizing infiltration. This method is normally used in small areas.
3. **C.B.** – City of Bryant
4. **City Engineer** – The civil engineer responsible for directing the Public Works Department in the execution of its duties.
5. **Public Works Department** - The department responsible for all stormwater management activities and implementation of the provisions of this ordinance.
6. **Collector and Arterial Streets and Highways** – These are certain streets as depicted on the latest City of Bryant Master Street Plan Map, for a particular design capacity and purpose.
7. **Commercial Development** – means any development that is not heavy industrial or residential. The category includes, but is not limited to: hospitals, laboratories and other medical facilities, educational institutions, recreational facilities, plant nurseries, multi-apartment buildings, car wash facilities, mini-malls and other business complexes, shopping malls, hotels, office buildings, public warehouses and other light industrial complexes.
8. **Common Plan of Development** - A contiguous area where multiple separate and distinct land disturbing activities may be taking place at different times, on different schedules, but under one proposed plan. One plan is broadly defined to include design, permit application, advertisement or physical demarcation indicating that land-disturbing activities may occur.
9. **Constructed Wetlands** – an artificial wetland system designed to mitigate the impacts of urban runoff.

10. **Construction Activity** - For this permit, construction activity includes construction activity as defined in 40 C.F.R. part 122.26(b)(14)(x) and small construction activity as defined in 40 C.F.R. part 122.26(b)(15). This includes a disturbance to the land that results in a change in the topography, existing soil cover (both vegetative and non-vegetative), or the existing soil topography that may result in accelerated storm water runoff, leading to soil erosion and movement of sediment into surface waters or drainage systems. Examples of construction activity may include clearing, grading, filling and excavating. Construction activity includes the disturbance of less than one acre of total land area that is a part of a larger common plan of development or sale if the larger common plan will ultimately disturb one (1) acre or more.
11. **Construction Site Erosion Control** - Preventing or reducing soil erosion and sedimentation from land disturbing activity.
12. **Contractor Certification Program** – a voluntary program in which the city will provide periodic seminars and training to educate contractors and other professionals on the proper procedures for installation and maintenance of erosion and sediment control measures and related matters. Refer to the City of Bryant Best Management Practices manual for additional information.
13. **Debris** – Any material including floating woody materials and other trash, suspended sediment, or BPWD load, moved by a flowing stream.
14. **Detention** - The temporary detaining or storage of floodwater in reservoirs, on parking lots, on rooftops and other areas under predetermined and controlled conditions and accompanied by controlled release of the stored water.
15. **Detention Basin** – An open excavation or depression in the ground surface used for temporary storage of storm water prior to release downstream.
16. **Detention Pond** - A stormwater detention facility which maintains a fixed minimum water elevation between runoff events except for the lowering resulting from losses of water due to infiltration or evaporation.
17. **Develop land** - To change the runoff characteristics of a parcel of land in conjunction with residential, commercial, industrial, or institutional construction or alteration.
18. **Developer** – Any person or entity proposing building or land improvements.
19. **Development** – Any construction, rehabilitation, redevelopment or reconstruction of any public or private residential project (whether single-family, multi-unit or planned unit development); industrial, commercial, retail and other non-residential projects, including public agency projects; or mass grading for future construction. It does not include routine maintenance to maintain original line and grade, hydraulic capacity. Or original purpose of facility, nor does it include emergency construction activities required to immediately protect public health and safety.

20. **Development** - Should generally mean any of the following actions undertaken by a public or private individual or entity:
- a. The division of a lot, tract or parcel of land into two (2) or more lots, plots, sites, tracts, parcels or other divisions by plat or deed, or
 - b. Any land change, including, without limitation, clearing, tree removal, grubbing, stripping, dredging, grading, excavating, transporting and filling of land.
21. **Disturbed Area** – means an area that is altered as a result of clearing, grading, and/or excavation.
22. **Drainage Area** – All land area that contributes runoff to the same discharge point.
23. **Drainage Basin** – All land area contributing to a given discharge point in terms of drainage.
24. **Drainage Easement** - Authorization by a property owner for use by another party or parties for all or any portion of his/her land for a drainage and adjoining utility purposes. Easements shall be dedicated to the City when required or approved by the Administrative Authority.
25. **Drainage Pipe** – Drainage conduit, which carries storm water flows in either a closed storm water sewer system or culverts. RCP, CMP & HDPE are some common drainage pipes used throughout the state.
26. **Duplex** – Two housing units that share a common wall.
27. **Easement** - Shall mean a grant or reservation by the owner of land for the use of such land by others for a specific purpose or purposes, and which must be included in the conveyance of land affected by such easement.
28. **Elevation or Elevations** – All required elevations shall be based on mean sea level datum.
29. **Emergency Flood Insurance Program or emergency program** - Means the program as implemented on an emergency basis in accordance with the NFIP. It is intended as a program to provide a first layer amount of insurance on all insurable structures before the effective date of the initial FIRM.
30. **Engineer** – A person who is a registered professional engineer in the State of Arkansas.
31. **Engineer of Record** - A registered professional engineer in Arkansas. This engineer shall supervise the design and construction of the development project and shall be acceptable to the City Engineer.

32. **Erosion** – the wearing away of land surfaces by the action of wind or water.
33. **Erosion Prevention** - Measures employed to prevent erosion including but not limited to: soil stabilization practices, limited grading, mulch, temporary or permanent cover, and construction phasing.
34. **Excavation** - Any act by which organic matter, earth, sand, gravel, rock or any other similar material is cut into, dug, quarried, uncovered, removed, displaced, relocated or bulldozed and shall include the resulting conditions.
35. **Existing Development** – Buildings and other structures and impervious areas existing prior to ordinance adoption.
36. **Existing Structure** – Means for the purposes of determining rates, structures for which the “start of construction” commenced before the effective date of the FIRM or before January 1, 1975, for FIRMs effective before that date.
37. **Fill** - Any act by which earth, sand, gravel, rock or any other material is deposited, placed, replaced, pushed, dumped, pulled, transported, or moved to a new location and shall include the resulting conditions.
38. **Final Stabilization** - means that either:
 - a. All soil disturbing activities at the site have been completed and a uniform (e.g., evenly distributed, without large bare areas) perennial vegetative cover with a density of 70% of the native background vegetative cover for the area has been established on all unpaved areas and areas not covered by permanent structures, or equivalent permanent stabilization measures (such as the use of riprap, gabions, or geotextiles) have been employed;
 - b. For individual lots in residential construction by either: (a) The homebuilder completing **final stabilization** as specified above, or (b) the homebuilder establishing temporary stabilization including perimeter controls for an individual lot prior to occupation of the home by the homeowner and informing the homeowner of the need for, and benefits of, **final stabilization**. (Homeowners typically have an incentive to put in the landscaping functionally equivalent to **final stabilization** as quick as possible to keep mud out of their homes and off sidewalks and driveways.); or
 - c. For construction projects on land used for agricultural purposes (e.g., pipelines across crop or range land) **final stabilization** may be accomplished by returning the disturbed land to its preconstruction agricultural use. Areas disturbed that were not previously used for agricultural activities, such as buffer strips immediately adjacent to **surface waters** and drainage systems, and areas which are not being returned to their preconstruction agricultural use must meet the **final stabilization** criteria in (a) or (b) above.

39. **Freeboard** – The vertical clearance of the lowest structural member of the bridge superstructure above the water surface elevation of the overtopping flood; the vertical distance between the level of the water surface usually corresponding to the design flow and a point of interest such as levee top or specific location on the roadway grade.
40. **General Contractor** - The party who signs the construction contract with the owner to construct the project described in the final plans and specifications. Where the construction project involves more than one contractor, the general contractor will be the party responsible for managing the project on behalf of the owner. In some cases, the owner may be the general contractor. In these cases, the owner may contract an individual as the operator who would become the Co-Permittee.
41. **Good Housekeeping Practice** – a common practice related to the storage, use, or cleanup of materials performed in a manner that minimizes the discharge of pollutants. Examples include cleaning up spills and leaks and storing materials in a manner that will contain any leaks and spills.
42. **Grading** - Shall mean excavating, filling (including hydraulic fill), or stockpiling of earth material, or any combination thereof, including the land in its excavated or filled condition.
43. **Household Hazardous Waste** - A product that is discarded from a home or a similar source that is either ignitable, corrosive, reactive, or toxic (e.g. used motor oil, oil-based paint, auto batteries, gasoline, pesticides, etc.).
44. **Illegal Discharge** - Any direct or indirect non-storm water discharge to the storm drain system, except as exempted in this Ordinance.
45. **Illegal/Illicit Connections** - An illicit connection is defined as either of the following:
 - a. Any drain or conveyance, whether on the surface or subsurface, which allows illegal discharge to enter the storm drain system including, but not limited to, any conveyances which allow any non-storm water discharge including, sewage, process wastewater, and wash water to enter the storm drain system and any connections to the storm drain system from indoor drains and sinks, regardless of whether said drain or connection had been previously allowed, permitted, or approved by an authorized enforcement agency or,
 - b. Any drain or conveyance connected from and commercial or industrial land use to the storm drain system which has not been documented in plans, maps or equivalent records and approved by an authorized enforcement agency.
46. **Impervious** – a hard surface (such as a parking lot), which prevents or retards the entry of water into the soil, thus causing water to run off the surface in greater quantities and at an increased flow rate. Examples include rooftops, sidewalks, patios, driveways, parking lots, storage areas, and concrete, asphalt, or gravel roads.

47. **Infiltration** – means the downward entry of water into the surface of the soil or the flow of a fluid through pores or small openings, commonly used in hydrology to denote the flow of water into soil material.
48. **Legal Authority** – defined as the ability to impose and enforce statutes, ordinances, and regulations to require control of pollutant sources and regulate the discharge of pollutants to the storm drain system, and to enter into interagency agreements, contracts, and memorandums of understanding.
49. **Litter** - Waste that is improperly disposed of on the street, sidewalk, lakes and other bodies of water, and in the general environment.
50. **Municipal Separate Storm Sewer System (MS4)** – conveyance or system of conveyances (including roads with drainage systems, municipal streets, catch basins, curbs, gutters, ditches, man-made channels, or storm drains) owned or operated by a state, city, town, borough, county, parish, district, association, or other public body (created by or pursuant to state law) having jurisdiction over disposal of sewage, industrial wastes, stormwater, or other wastes, including special districts under state law such as a sewer district, flood control or drainage district, similar entity, and Indian tribe or an authorized Indian tribal organization, or a designated and approved management agency under Section 208 of the Clean Water Act that discharges to water of the United States.
51. **Natural Waterways** - Shall mean waterways that are part of the natural topography. They usually maintain a continuous or seasonal flow during the year and are characterized as being irregular in cross-section with a meandering course. Construction channels such as drainage ditches shall not be considered natural waterways.
52. **New Structure** – Structures for which the start of construction commences on or after the effective date of these regulations.
53. **Non-Storm Water Discharge** - Any discharge to the storm drain system that is not composed entirely of storm water.
54. **Non-structural BMP** – a best management practice that does not require construction of a facility to control urban runoff.
55. **Notice of Intent (NOI)** - Application form for obtaining coverage under a General Storm Water Permit for construction activities that disturbs one or more acres or for industrial activities.
56. **Notice of Termination** – A notice to terminate coverage under this permit after construction is complete, the site has undergone final stabilization, and maintenance agreements for all permanent facilities have been established, in accordance with all applicable conditions of this permit.

57. **NPDES** – National Pollutant Discharge Elimination System initiated in 1972 by the amendments to the Federal Water Pollution Control Act (the Clean Water Act or CWA) to address the discharge of pollutants to navigable waters from point sources unless the discharge is authorized by an NPDES permit. The Water Quality Act of 1987 added section 402(p) to the CWA establishing phased and tiered requirements for stormwater discharge under the NPDES program.
58. **Owner** - The person or party possessing the title of the land on which the construction activities will occur; or if the construction activity is for a lease holder, the party or individual identified as the lease holder; or the contracting government agency responsible for the construction activity.
59. **Permittee** – A person, partnership or corporation to whom a permit is granted.
60. **Permittee** - A person or persons, firm, or governmental agency or other institution that signs the application submitted to AEDQ and is responsible for compliance with the terms and conditions of this permit.
61. **Person Responsible for the Land Distributing Activity** - The person who has or represents having financial or operation control over the land disturbing activity; and/or the landowner or person in possession or control of the land who directly or indirectly allowed the land disturbing activity or has benefited from it or who has failed to comply with any provision of this ordinance.
62. **Point Source** – pollution arising from a well-defined origin, such as a discharge from an industrial plant.
63. **Pollutant** – any introduced gas, liquid, or solid that makes a resource unfit for a specific purpose. A substance that pollutes air, water or land. They are defined in Section (502) of the federal Clean Water Act (33 U.S.C. ‘ 1362(6)). Specifically, pollutants that are carried by runoff from rainstorms or other watering activities. Examples of pollutants include but are not limited to the following:
 - a. Commercial and industrial waste (such as fuels, solvents, detergents, plastic pellets, hazardous substances, fertilizers, pesticides, slag, ash, and sludge);
 - b. Metals such as cadmium, lead, zinc, copper, silver, nickel, and chromium; and non-metals such as phosphorus and arsenic;
 - c. Petroleum hydrocarbons (such as fuels, lubricants, surfactants, waste oils, solvents, coolants, and grease);
 - d. Excessive eroded soils, sediment, and particulate materials in amounts which may adversely affect the beneficial use of the receiving waters, flora, or fauna;
 - e. Animal wastes (such as discharge from confinement facilities, kennels, pens, recreational facilities, stables, and show facilities);

- f. Substances having characteristics such as pH less than 6 or greater than 9, unusual coloration or turbidity, excessive levels of fecal coliform, fecal streptococcus, or enterococcus.
- 64. **Post-Development** - Refers to the extent and distribution of land cover types anticipated to occur under conditions of full development of the submitted plan. This term is used to match pre- and post-development stormwater peak flows as required by the ordinance.
- 65. **Pre-Developed Conditions** - Those land use conditions that existed prior to the initiation of the land disturbing activity in terms of topography, vegetation, or land use and rate, volume, or direction of stormwater runoff.
- 66. **Pre-Development** - Refers to the extent and distribution of land cover types present before the initiation of land development activity, assuming that all land uses prior to land disturbing activity and in “good” condition as described in the Natural Resources Conservation Service Technical Release 55, Urban Hydrology for Small Watersheds” (commonly known as TR-55). This term is used to match pre- and post-development stormwater peak flows as required by the ordinance. In a situation where cumulative impervious surface created after the adoption of this ordinance exceeds the 20,000 sq. ft. threshold, the pre-development conditions shall be those prior to any land disturbance.
- 67. **Raingarden** - (1) Shallow depressions designed to collect rain on the site – typically runoff from impervious surfaces such as roofs – and allow plants, bacteria and soils to clean the water as it seeps into the ground. (2) A strategically located low area planted with native vegetation that intercepts runoff. Other terms include mini-wetland, stormwater garden, water quality garden, stormwater marsh, backyard wetland or bioretention pond.
- 68. **Receiving Water** – rivers, lakes, oceans, or other bodies that receive runoff.
- 69. **Redevelopment** – land-disturbing activity that results in the creation or addition or replacement of 5,000 square feet or more of impervious surface area on an already developed site. Where redevelopment results in an alteration to more than fifty percent of impervious surfaces of a previously existing development, and the existing development was not subject to post development storm water quality control requirements, the entire project must be mitigated. Where Redevelopment results in an alteration to less than fifty percent of impervious surfaces of a previously existing development, and the existing development was not subject to post development storm water quality control requirements, only the alteration must be mitigated, and not the entire development. Redevelopment does not include routine maintenance activities that are conducted to maintain original line and grade, hydraulic capacity, original purpose of facility or emergency redevelopment activity required to protect public health and safety. Existing single family structures are exempt from the redevelopment requirements.

70. **Registered Landscape Architect** - A landscape architect properly registered and licensed to conduct work within the State of Arkansas.
71. **Registered Land Surveyor** - A land surveyor properly registered and licensed to conduct work within the State of Arkansas.
72. **Registered Professional Engineer** - Shall mean a professional engineer properly registered and licensed to conduct work within the State of Arkansas.
73. **Regulatory Floodway** – The floodplain area that is reserved in an open manner by Federal, State or local requirements, i.e., unconfined or unobstructed either horizontally or vertically, to provide for the discharge of the base flood so that the cumulative increase in water surface elevation is no more than a designated amount (not to exceed 1 foot as established by the Federal Emergency Management Agency (FEMA) for administering the National Flood Insurance Program).
74. **Retention Structure** - A permanent structure whose primary purpose is to permanently store a given volume of stormwater runoff. Release of the given volume is by infiltration and/or evaporation.
75. **Riparian Buffer** - A natural or vegetated area adjacent to streams and perennial water bodies through which stormwater flows in a diffuse manner, so that runoff does not become channelized and which provides for the infiltration of runoff and filtering of pollutants. The riparian buffer is measured landward (horizontal distance) from the stream bank on both sides of the stream or from the normal pool elevation of a perennial water body.
76. **Riverine** – means relating to, formed by, or resembling a river (including tributaries), stream, brook, etc.
77. **Runoff** – the portion of rainfall or irrigation water and other watering activities also known as dry-weather flows that flow across the ground surface and eventually to receiving waters. Runoff can pick up pollutants from the air or the land and carry them to receiving waters.
78. **Sediment** – Fragmentary material that originates from weathering of rocks and is transported by, suspended in, or deposited by water.
79. **Sediment** - Solid earth material, both mineral and organic, that is in suspension, is being transported, or has been moved from its site of origin by air, water, gravity or ice, and has come to rest on the earth's surface at a different site.
80. **Sediment Control** - Methods employed to prevent sediment from leaving the site. Sediment control practices include silt fences, sediment traps, earth dikes, drainage swales, check dams, subsurface drains, pipe slope drains, storm drain inlet protection, and temporary or permanent sedimentation basins.

81. **Stormwater** – Water which originates from atmospheric moisture (rainfall or snowmelt) and falls onto land, water, or other surfaces.
82. **Stormwater Management Plan** - The set of drawings and other documents that comprise all of the information and specifications for the drainage systems, structures, concepts and techniques that will be used to control stormwater as required by this Ordinance and the Stormwater Management Manual. Also included are the supporting engineering calculations and results of any computer analysis.
83. **Stormwater Management Manual** - The set of drainage policies, analysis methods, design charts, stormwater runoff methods, and design standards used by the City as the official design guidelines for drainage improvements consistent with this Ordinance. Any modifications will be made by the Administrative Authority consistent with the stated policies and intent of the Ordinance.
84. **Stormwater Pollution Prevention Plan (SWPPP)** – A plan designed to eliminate or reduce at the source the use, generation, or release of silts, toxic pollutants, hazardous substances, and hazardous wastes from entering storm waters.
85. **Stormwater Runoff** - Water that results from precipitation which is not absorbed by the soil, evaporated into the atmosphere or entrapped by ground surface depressions and vegetation, which flows over the ground surface.
86. **Stream** – A body of running water.
87. **Urban Forestry** – (1) The management of trees for their contribution to the physiological, sociological, and economic well-being of urban society. Urban forestry deals with woodlands, groups of trees, and individual trees, where people live - it is multifaceted, for urban areas it includes a great variety of habitats (streets, parks, derelict corners, etc) where trees bestow a great variety of benefits and problems. (2) The art, science and technology of managing trees, forests, and natural systems in and around urban areas for the health and well being of communities.
88. **Waters of the State** - All streams, lakes, ponds, marshes, watercourses, waterways, wells, springs, reservoirs, aquifers, irrigation systems, drainage systems and all other bodies or accumulations of water, surface or underground, natural or artificial, public or private, which are contained within, flow through, or border upon the state or any portion thereof.

SECTION 200
STORMWATER MANAGEMENT PLANNING AND SUBMITTAL

	<u>Page</u>
200.1 SUBMITTAL AND REVIEW PROCESS	20
200.2 CONSTRUCTION SITES	20-21
200.3 STORMWATER MANAGEMENT PLAN REQUIREMENTS	21-26
200.4 STORMWATER POLLUTION PREVENTION PLAN	27-28
200.5 DETENTION PLAN REQUIREMENTS	28-30
200.6 STORMWATER QUALITY PLAN REQUIREMENTS	30-31
200.7 PERMITS AND FEES REQUIRED	31
200.8 NPDES PERMITS	31
200.9 NOTICE OF TERMINATION REQUIREMENTS	31
200.10 ARKANSAS HIGHWAY AND TRANSPORTATION DEPARTMENT	32
200.11 MASTER DRAINAGE STUDY	32

SECTION 200 STORMWATER PLANNING AND SUBMITTAL

200.1 SUBMITTAL AND REVIEW PROCESS

200.1.1 Large, Medium, and Small Construction Sites as described below are required to submit the following documents to the City of Bryant prior to any earth moving activities:

- a. Stormwater Management Plan
- b. Stormwater Pollution Prevention Plan (SWPPP)
- c. Stormwater Detention Plan
- d. Stormwater Quality Plan
- e. A copy of the approved ADEQ NPDES permit

200.1.2 Special Construction Sites as described below are required to execute the following tasks prior to any earth moving activities:

- a. Post on-site (ADEQ) Stormwater Construction Notice
- b. Develop Stormwater Pollution Prevention Plan (SWPPP)
- c. Submit copy of SWPPP to CHS prior to construction for review.
- d. Use Best Management Practices (BMPs) to reduce runoff.
- e. Maintain SWPPP on-site and inspect stormwater controls weekly.
- f. Remove all unnecessary BMPs after final stabilization.
- g. Maintain a solid waste dumpster located at the site to properly dispose of building materials and solid waste.

200.2 CONSTRUCTION SITES

1. **Large Construction Sites:** any construction activity that meets the following definition:
 - a. Construction sites that will result in the disturbance (e.g., clearing, grading, excavating, etc.) of ten (10) or more acres of total land area; or less than ten (10) acres of total land area that is part of a larger common plan of development, or sale, if the larger common plan will ultimately disturb ten (10) acres or more.
2. **Medium Construction Sites:** any construction activity that meets the following definition:
 - a. Construction sites that will result in the disturbance (e.g., clearing, grading, excavating, etc.) of greater than five (5) acres and less than ten (10) acres of total land area; or less than five (5) acres of total land area that is part of a larger common plan of development, or sale, if the larger common plan will ultimately disturb five (5) acres or more, but less than ten (10) acres.
3. **Small Construction Sites:** any construction activity that meets the following definition:

- a. Construction sites that will result in the disturbance (e.g., clearing, grading, excavating, etc.) of greater than or equal to one (1) acre and less than five (5) acres of total land area; or less than one (1) acre of total land area that is part of a larger common plan or development, or sale, if the larger common plan will ultimately disturb one (1) acre or more, but less than five (5) acres.
4. **Special Construction Sites:** Any construction activity that meets the following definition:
- a. Any construction activity (e.g. clearing, grading, excavating, etc.) greater than 4,000 square feet and less than 1 acre of land that is adjacent to any lake, stream, tributary, creek or other flowing body of water.
 - b. Road, pipeline, and utility maintenance activities are not regulated under this permit unless one or more acres of underlying and/or surrounding soil are cleared, graded, or excavated as part of the operation.
 - c. Road, pipeline, and utility maintenance activities are regulated when bordering lakes or streams under either the small, medium or large construction site category.

The ultimate objective of this program is to protect water quality. The City of Bryant recognizes the need and responsibility to implement a program that achieves the requirements mandated by NPDES Phase II Final Rule.

200.3 STORMWATER MANAGEMENT PLAN REQUIREMENTS

1. Stormwater Management Plan. Every applicant for a building permit that involves land disturbing activities that are large, medium or small construction sites per paragraph 200.2-Construction Sites, must submit a stormwater management plan and SWPPP to the Administrative authority. Special construction sites must meet the submittal requirements spelled out per paragraph 200.2-Construction Sites. No building permit, subdivision approval, or permit to allow land disturbing activities shall be issued until approval of this plan. All plans shall be consistent with National Pollution Discharge Elimination Permit (NPDES) requirements, and the filing or approval requirements of the Arkansas Department of Environmental Quality, U.S. Army Corps of Engineers, Federal Emergency Management Agency, and relevant Watershed Districts, Watershed Management Organizations, Ditch Authorities, Soil and Water Conservation Districts, and other regulatory bodies. All stormwater mitigation and management technologies shall be consistent with the City of Bryant Stormwater management manual (Design Manual).

- a. The stormwater management plan for small, medium and large construction sites shall be prepared by the engineer of record, who is a licensed professional engineer in the State of Arkansas.
 - b. The SWPPP and Stormwater Construction Notice for special construction sites are not required to be prepared by an engineer.
 - c. If needed, a review meeting should be scheduled with the Administrative authority and include a representative of the developer and the design engineer, to review the overall concepts included in a preliminary stormwater management, drainage, and erosion control plan. The purpose of this review would be to jointly agree upon an overall stormwater management concept for the proposed development and to review criteria and design parameters that will apply to final design of the project.
2. General Policy on Erosion Control. Erosion control plans will be included in the Stormwater Management Plan. The Erosion Control Plan shall be required for small, medium, large and special projects as described in Paragraph 200.2 - Construction Sites and shall meet the following criteria:
- a. Minimize, in area and duration, exposed soil and unstable soil conditions.
 - b. Minimize disturbance of natural soil cover and vegetation.
 - c. Protect receiving water bodies, wetlands and storm sewer inlets.
 - d. Protect adjacent properties from sediment deposition.
 - e. Minimize off-site sediment transport on trucks and equipment.
 - f. Minimize work in and adjacent to water bodies and wetlands.
 - g. Maintain stable slopes.
 - h. Avoid steep slopes and the need for high cuts and fills.
 - i. Minimize disturbance to the surrounding soils, root systems and trunks of trees adjacent to site activity that are intended to be left standing.
 - j. Minimize the compaction of site soils.
3. The minimum requirements of the Stormwater Management Plan shall be consistent with the most recent version of the Arkansas Department of Environmental Quality's NPDES Construction Permit Requirements. A checklist similar to the ADEQ checklist is appended to this Manual.
- a. Identification and description
 1. Project name;
 2. Project type (residential, commercial, industrial, road construction, or other);
 3. Project location;
 4. Legal description;
 5. Names and addresses of the record owner, developer, land surveyor, engineer, designer of the plat, and any agents, contractors, and subcontractors who will be responsible for project implementation;
 6. Identification of the entity responsible for long term maintenance of the project. This includes a maintenance plan and schedule for all temporary and permanent stormwater practices;

7. Identification of the nature of the construction activity and the potential for sediment and other pollutant discharges from the site;
 8. Phasing of construction with estimated start date, time frames and schedules for each construction phase, and completion date;
 9. Copies of permits or permit applications required by any other governmental entity or agencies including mitigation measures required as a result of any review for the project (e.g. wetland mitigation, EAW, EIS, archaeology survey, etc.).
4. Existing Conditions - A complete site plan and specifications, prepared and signed by a Professional Engineer licensed in the State of Arkansas. The plan shall be drawn to an easily legible scale, shall be clearly labeled with a north arrow and a date of preparation, and shall meet the following conditions and include, at a minimum, the following information:
- a. Project map – An 8.5 by 11 inch United States Geological Survey (USGS) 7.5 minute quad or equivalent map indicating site boundaries and existing elevations.
 - b. Property lines and lot dimensions.
 - c. Existing zoning classifications for land within and abutting the development, including shoreland, floodway, flood fringe, or general floodplain, and other natural resource overlay districts.
 - d. All buildings and outdoor uses including all dimensions and setbacks.
 - e. All public and private roads, interior roads, driveways and parking lots.
 - f. Identify all natural and artificial water features (including drainage culverts) on site, including, but not limited to lakes, ponds, streams (including intermittent streams), and ditches. Show ordinary high water marks of all navigable waters, 100-year flood elevations and delineated wetland boundaries, if any. If not available, appropriate flood zone determination or wetland delineation, or both, may be required at the applicant's expense.
 - g. Map of watershed drainage areas, soil types, infiltration rates, depth to BPWDrock, and depth to seasonal high water table. The Garland County Soil Survey Manual or a geotechnical investigation of the project site shall be used to determine existing soil types.
 - h. Existing grades showing drainage on and adjacent to the site.
 - i. Existing impervious surfaces.
 - j. Steep slopes where areas of 12% or more exists over a distance of 50 feet or more.
 - k. Locations of all areas not to be disturbed during construction including trees, vegetation, and appropriated areas for infiltration.
 - l. Bluff areas where the slope rises at least 25 feet above the toe of the bluff and the grade of the slope from the toe of the bluff to a point 25 feet or more above the toe of the bluff averages 30% or greater.
 - m. Wooded area and tree survey.
 - n. Agricultural Land preservation area(s) or other officially designated natural resources.

- o. Hydrologic calculations for volume runoff, velocities, and peak flow rates by watershed, for the 2.0-yr, 10-yr, and 100-yr 24-hour storm events. These shall include:
 1. Pre-existing peak flow rates.
 2. Assumed runoff curve numbers.
 3. Time of concentration used in calculations.
 4. The 100-year flood elevation with and without the floodway.
5. Proposed Conditions - A complete site plan and specifications, prepared and signed by a Professional Engineer licensed in the State of Arkansas. The plan shall be drawn to an easily legible scale, shall be clearly labeled with a north arrow and a date of preparation, and shall meet the following conditions and include, at a minimum, the following information:
 - a. Project map – An 8.5 by 11 inch United States Geological Survey (USGS) 7.5 minute quad or equivalent map indicating site boundaries, proposed elevations, and areas not to be disturbed;
 - b. Property lines and lot dimensions of plat.
 - c. The dimensions and setbacks of all buildings and easements.
 - d. The location and area of all proposed impervious surfaces including public and private roads, interior roads, driveways, parking lots, pedestrian ways, and rooftops. Show all traffic patterns and types of paving and surfacing materials.
 - e. Location, size, and approximate grade of proposed public sewer and water mains.
 - f. Limit total off-site permissible annual aggregate soil loss for exposed areas resulting from sheet and rill erosion to an annual, cumulative soil loss rate not to exceed 8.0 tons per acre annually. This shall be determined by using a commonly accepted soil erosion methodology approved by the Administrative authority that considers the season of year, site characteristics, soil erodibility and length and steepness of slopes.
 - g. Elevations, sections, profiles, and details as needed to describe all natural and artificial features of the project.
 - h. Identify all natural and artificial water features on site, including, but not limited to lakes, ponds, streams (including intermittent streams), and ditches. Show ordinary high water marks of all navigable waters, 100-year flood elevations and delineated wetland boundaries, if any. If not available, appropriate flood zone determination or wetland delineation, or both, may be required at the applicant's expense.
 - i. Hydrologic calculations for volume runoff, velocities, and peak flow rates by watershed, for the 2.0-yr, 10-yr, and 100-yr 24-hour storm events. These shall include:
 1. Post construction peak flow rates with no detention.
 2. Post construction peak flow rates with detention.
 3. Assumed runoff curve numbers.
 4. Time of concentration used in calculations.
 5. The 100-year flood elevation with and without the floodway.
 - j. Locations of all stormwater management practices, infiltration areas, and areas not to be disturbed during construction.

- k. Proposed grading or other land-disturbing activity including areas of grubbing, clearing, tree removal. Grading excavation, fill and other disturbance; areas of soil or earth material storage; quantities of soil or earth material to be removed, placed stored or otherwise moved on or off the site, and delineated limits of disturbance.
- l. Locations of proposed runoff control, erosion prevention, sediment control, and temporary and permanent soil stabilization measures.
- m. Structural Practices. A description of structural practices to divert flows from exposed soils, store flows or otherwise limit runoff and the discharge of pollutants from exposed areas of the site to the degree attainable. Structural practices should be placed on upland soils to the degree attainable. The installation of these devices may be subject to Section 404 of the Clean Water Act. Such practices may include:
 - 1. Silt fences (installed and maintained)
 - 2. Earth dikes
 - 3. Drainage swales
 - 4. Check dams
 - 5. Subsurface drains
 - 6. Pipe slope drains
 - 7. Level spreaders
 - 8. Storm drain inlet protection
 - 9. Rock outlet protection
 - 10. Sediment traps
 - 11. Reinforced soil retaining systems
 - 12. Gabions
 - 13. Temporary or permanent sediment basins
- n. Proposed grades showing drainage on and adjacent to the site.
- o. Proposed impervious surfaces.
- p. Provide that all silt fences and other practices used for erosion and sedimentation control shall not be removed until the City of Bryant has determined that the site has been permanently stabilized and shall be removed within 30 days thereafter.
- q. Steep slopes where areas of 12% or more exists over a distance of 50 feet or more.
- r. Design and construction methods to stabilize steep slopes.
- s. Stabilization of all waterways and outlets, and velocity dissipaters.
- t. Protection of storm sewer infrastructure from sediment loading/plugging.
- u. Location of temporary sedimentation basins - If more than 10 acres are disturbed and drained to a single point of discharge temporary sediment basins must be installed, however, if the site has sensitive features as determined by the community or the potential of off site impacts, then temporary sediment basins must be installed to protect the resource. This is determined on a site by site basis. When site restrictions do not allow for a temporary sediment basin, equivalent measures such as smaller basins, check dams, and vegetated buffer strips can be included.

- v. Location and engineered designs for structural stormwater management practices including stormwater treatment devices that remove oil and floatable material (e.g., basin outlets with submerged entrances).
 - w. Stabilization of disturbed areas, including utility construction areas, as soon as possible.
 - x. Protection of outlying roads and drainage systems from sediment and mud from construction site activities.
 - y. Normal water level, high water level, and emergency overflow elevations for the site.
 - z. For discharges to cold water fisheries, a description and plans to control temperature from stormwater runoff.
 - aa. Floodway and flood fringe boundary, if available.
 - bb. Disposal of collected sediment and floating debris.
 - cc. Any additional measures to comply with surface and groundwater standards in sensitive areas.
6. All proposed stormwater practices, hydrologic models, and design methodologies shall be reviewed by the Administrative authority and certified for compliance in accordance with the Stormwater management manual.
7. Review and approval of final stormwater management plan. Final stormwater management plan shall be reviewed by the Administrative authority. If it is determined according to present engineering practice that the proposed development will provide control of erosion and stormwater runoff in accordance with the purposes, design criteria, and performance standards of these regulations and will not be detrimental to the public health, safety, and general welfare, the Administrative authority shall approve the plan or conditionally approve the plan, setting forth the conditions thereof.
8. If it is determined that the proposed development will not control stormwater runoff, erosion and sedimentation in accordance with these regulations, the Administrative authority shall disapprove the final stormwater management and drainage plan.

200.4 STORMWATER POLLUTION PREVENTION PLAN

1. Under the NPDES General Permits for Stormwater Discharge from Construction Sites, EPA requires the development and implementation of a stormwater pollution prevention plan (SWPPP). A SWPPP for construction is designed to reduce pollution at the construction site, before it can cause environmental problems. Many of the practices and measures required for the SWPPP represent standard operating procedures at many construction sites. Stormwater management controls, erosion and sediment controls, inspection and maintenance have all been used at a number of construction sites.
2. A requirement of the construction storm water permit is to develop a SWPPP before construction activities begin. The following paragraphs will step through each item to be addressed in the SWPPP. You will be able to develop a SWPPP that will normally fulfill the requirements of the Arkansas Department of Environmental Quality by following this guide.
3. A step-by-step process for ensuring that pollutants are not making their way into the stormwater discharges from a project consists of six major phases. The six major phases of the process are (1) site evaluation and design development, (2) assessment, (3) control selection and plan design, (4) certification and notification, (5) construction/implementation, and (6) final stabilization/termination.
4. Site Evaluation and Design Development Phase. The first phase in preparing a SWPPP for a construction project is to define the characteristics of the site and the type of construction that will be occurring. This phase is broken down into four requirements: (a) collect site information, (b) develop site design, (c) describe construction activity, and (d) prepare pollution prevention site map.
5. Assessment Phase. Once the characteristics of the site and the construction have been defined, the next phase in developing the SWPPP is to measure the size of the land disturbance and estimate the impact the project will have on stormwater runoff from the site based on information collected in the Site Evaluation and Design Development Phase. Three things should be done to assess the project: (a) measure the site area, (b) measure the drainage areas, and (c) calculate the runoff coefficient.
6. Control Selection/Plan Design Phase. After you have collected the information and made measurements, the next phase is to design a plan to prevent and control pollution of stormwater runoff from your construction site. To complete the SWPPP, (a) review and incorporate State and local requirements, (b) select erosion and sediment controls, (c) select other controls, (d) select stormwater management controls, (e) indicate the location of controls in the site map, (f) prepare an inspection and

maintenance plan, (g) prepare a description of controls, and (h) prepare a sequence of major activities.

7. Certification and Notification Phase. Once the site description and controls portion of the SWPPP have been prepared, you now must (a) certify the pollution prevention plan and (b) submit a Notice of Intent to ADEQ. A checklist is provided at the end of this document at Appendix A to assist evaluating whether all the required items are included in your SWPPP prior to certifying the plan or submitting a Notice of Intent.
8. Construction/Implementation Phase. Once you have prepared a SWPPP and filed a Notice of Intent, you may start construction of the project upon approval by ADEQ. However, the items identified in the SWPPP must now take place: (a) implement the controls, (b) inspect and maintain the controls, (c) maintain records of construction activities, (d) update/change the plan to keep it current, (e) take proper action when there is a reportable quantity spill and (f) have plans accessible.
9. Final Stabilization/Termination Phase. Operators of a construction site must continue to comply with permit conditions until: (1) they no longer meet the definition of an operator of a construction site; or (2) the construction activity is complete, all disturbed soils have been finally stabilized, and temporary erosion and sediment controls have been or will be removed. A permittee is required to submit a Notice of Termination (NOT) to inform ADEQ that they are no longer an operator of a construction activity.

200.5 DETENTION PLAN REQUIREMENTS

1. The City of Bryant requires the development and implementation of an on-site stormwater detention plan. An on-site detention plan for stormwater is designed to store the excess stormwater runoff associated with a increased watershed imperviousness and discharge this excess at a rate similar to the runoff rate from the watershed with pre-developed conditions. Stormwater management controls such as on-site detention are the preferred method of storage of detention runoff in excess of amounts to be expected from existing conditions is on-site detention.
2. The ability of on-site or regional detention to reduce flood peaks in the local drainage ways has been recognized by Bryant, and detention is therefore required in the watershed, unless the proposed system will connect to an existing system with a 100-year flood capacity.
3. On-Site and Regional Detention. Depending upon ownership of the site and the area tributary to a detention site, two types of detention are defined: (1) on-site, and (2) off-site or regional. On-site detention is defined as the privately owned and generally privately maintained facility which serves the developing area in question. Regional detention, also generally referred to as off-site detention, is publicly owned

and maintained and generally is part of a planned space park system or greenbelt area serving a larger portion of the basin. The importance of regional detention is the ability to assure that the facility will be maintained and will function as designed.

4. Where on-site detention is deemed inappropriate due to local topographical or other physical conditions, alternate methods for accommodating increases in stormwater runoff may be permitted. Any alternate method shall be approved in writing by the Public Works Department under the direction of the City Engineer prior to its consideration. The methods may include.
 - a. Off-site or Regional Detention.
 - b. In-lieu monetary contributions for drainage system improvements made by the City. Channel improvements shall only be used if they are an integral part of a detailed watershed management plan. No in-lieu contributions are allowed when:
 - i. Existing flooding occurs downstream from the development, or
 - ii. If the proposed development will cause downstream flooding.
5. Potential advantages and disadvantages of on-site detention basins should be considered by the designer in the early stages of development. Discharge rates and outflow velocities are regulated to conform to the capacities and physical characteristics of downstream drainage systems. Energy dissipation and flow attenuation resulting from on-site storage can reduce soil erosion and pollutant loading. By controlling release flows, the impacts of the pollutant loading of stored runoff on receiving water quality can be minimized.
6. Design. The City of Bryant will allow the use of the following software or an acceptable equal approved by the Administrative authority for the analysis of stormwater detention facilities.
 - a. Pond-2. Pond-2 is a program for detention pond design. Pond -2 is included in PondPack, a package developed by Haestad Methods, where it is integrated with Quick TR-55. It estimates detention storage requirements, computes a volume rating table for any pond configuration, routes hydrographs for different return frequencies through alternative ponds, and plots the resulting inflow and outflow hydrographs. Pond-2 automatically computes outflow rating curves for single or multi-stage outlet structures, and computes the controlling flow rate for outlets operating in series. Pond-2 handles orifices, weirs, box culverts, circular culverts, and more.
 - b. HEC-1. HEC-1 generates hydrographs from rainfall or snow melt, adds or diverts them, then routes them through reaches and reservoirs. HEC-1 models multiple stream and reservoir networks, and has dam failure simulation capabilities. It handles level-pool routing for reservoirs and detention ponds, and routes through stream reaches using Kinematic Wave, Muskingum,

Muskinum-Cunge, Modified Puls, and other methods. HEC-1 supports five methods for computing infiltration and abstraction losses, and computes unit hydrographs using the Clark methods, Snyder method, and SCS dimensionless hydrographs.

- c. HEC-HMS. The Hydrologic Modeling System is designed to simulate the precipitation-runoff processes of dendritic watershed systems. It is designed to be applicable in a wide range of geographic areas for solving the widest possible range of problems. This includes large river basin water supply and flood hydrology, and small urban or natural watershed runoff. Hydrographs produced by the program are used directly or in conjunction with other software for studies of water availability, urban drainage, flow forecasting, future urbanization impact, reservoir spillway design, flood damage reduction, floodplain regulation, and systems operation. The program features a completely integrated work environment including a database, data entry utilities, computation engine, and results reporting tools. A graphical user interface allows the user seamless movement between the different parts of the program. Program functionality and appearance are the same across all supported platforms.
7. Hydraulic Design Data. Stormwater detention pond outlets shall be designed to limit the peak stormwater discharge rate of the 2-, 10-, 25-, 50-, and 100-year storm frequencies after development to pre-development rates. The principal outlet will be designed to safely convey the runoff resulting from a 25 year event chance storm. A second outlet, the emergency outlet, will be designed to safely convey the runoff resulting from a 100 year event storm.
8. All private systems must be designed to discharge at pre-developed rates unless approved by the Public Works Department. New stormwater drainage systems cannot tie into existing systems of lesser capacity. In other words a larger pipe cannot discharge into a smaller pipe of lesser capacity.

200.6 STORMWATER QUALITY PLAN REQUIREMENTS

1. Stormwater Quality Plan Requirements. A developer may be required to prepare, submit and implement a Stormwater Quality Plan for a building permit that involves land disturbing activities that are large, medium or small construction sites per Paragraph 200.2-Construction Sites, per the Administrative authority's review. The Administrative authority upon review of the site conditions may determine that in order to protect the waterways of the City of Bryant that stormwater quality measures be implemented. This might occur on sites that discharge directly into the lakes, creeks and streams of Bryant and whose stormwater would have the potential of transferring pollutants into the waterways of Bryant. The following water quality measures will be used when the Administrative authority determines it is necessary:
 1. A non-mechanical screening process is an appropriate option to improve water quality from stormwater prior to entering the waterways of Bryant.

2. Buffer Zone. All land disturbing activities that are large, medium, small or special construction sites are required to establish a buffer zone when they adjoin creeks, streams, lakes or rivers. A buffer zone is an area of natural vegetation like grass, bushes and shrubbery. It may also be of a man-made nature such as rip rap, gabion mattresses and sediment-catching channels. A buffer zone protects natural waterways, creeks, streams, lakes and rivers from the direct impact of pollutants entering through stormwater from drainage pipes or impermeable areas by directly filtering pollutants from stormwater and through sediment catching detention measures.

200.7 PERMITS AND FEES REQUIRED

Permits and fees will be submitted per the current City of Bryant Stormwater Management Ordinance.

200.8 NPDES PERMITS

The United States Environmental Protection Agency (USEPA) has adopted regulations to control pollutants from entering the environment through storm drainage facilities. Locally, the Arkansas Department of Environmental Quality (ADEQ) administers a municipal stormwater discharge permitting program for the City of Bryant. The local National Pollutant Discharge Elimination System (NPDES) stormwater permit is issued to the City of Bryant.

In addition to mandating general municipal stormwater permits, USEPA's stormwater management program established permitting requirements for construction and industrial sites. ADEQ administers construction site and industrial site permitting programs for Arkansas. The emphasis of this portion of the program is on implementing best management practices (BMP) to control non-point source pollution generated from active construction sites and industrial operations. ADEQ issues permits, collects fees associated with permit application and approval, and is responsible for permit monitoring and enforcement.

Non-point sources of pollution are diffuse sources, which are distributed throughout the watershed and contribute to receiving waters at multiple locations. They are contrasted with point sources, which contribute pollution to receiving waters at a single definable point.

ADEQ is working with the City of Bryant to distribute information related to the construction and industrial permits as part of the permitting process.

200.9 NOTICE OF TERMINATION REQUIREMENTS

Upon completion of construction, submit a Notice of Termination to The City of Bryant Public Works Department and the Arkansas Department of Environmental Quality.

200.10 ARKANSAS HIGHWAY AND TRANSPORTION DEPARTMENT

Arkansas Highway and Transportation Department (AHTD) regulations and requirements shall take precedence over the City of Bryant regulations and requirements for that portion of work being performed within AHTD right-of-way. The developer, project engineer, and contractor shall be responsible for making all necessary submittals, applications and payment of fees as may be required by AHTD. BPWD may, at its discretion, require proof of AHTD approvals and permitting.

200.11 MASTER DRAINAGE STUDY

BPWD may, at its discretion, require a master drainage study for multi-staged projects or proposed developments that may adversely impact areas in the vicinity. A master drainage plan is not normally required unless specifically requested by BPWD. When a master drainage study is requested, BPWD will define the limits of the study area, as well as the required study criteria.

SECTION 300
STORM WATER MANAGEMENT POLICY

	Page
300.1 INTRODUCTION	34
300.2 AUTHORITY FOR REGULATIONS	34
300.3 ADMINISTRATIVE POLICY	34-35
300.4 DESIGN POLICY	35-50

SECTION 300 STORM WATER MANAGEMENT POLICY

300.1 INTRODUCTION

These policies shall govern the planning, design, construction, operation and maintenance of all storm drainage facilities within the City of Bryant. Definitions, formulas, criteria, procedures and data presented herein have been developed to support these policies. If a conflict arises between the technical data and these policies, the policies shall govern.

300.2 AUTHORITY FOR REGULATIONS

Cities and Counties in Arkansas have the authority to pass ordinances controlling drainage through the subdivision plat approval process. Cities and Counties may impose regulations on developers to regulate runoff from a development and specify stormwater criteria. The authorizations are generally provided in various Arkansas statutes.

300.3 ADMINISTRATIVE POLICY

300.3.1 Approvals

All storm drainage related plans, both public and private, must have written approval from the City of Bryant Public Works Department (BPWD), in accordance with the procedures described in this manual prior to beginning construction.

300.3.2 Manual Revisions

When necessary, revisions to the Stormwater management manual will be issued in writing and shall only be made by the City of Bryant Administrative authority. Changes or modifications to the Stormwater management manual will be summarized in errata sheets and will be distributed to manual holders as necessary. Major changes affecting policy, criteria, methodologies, or engineering data will be distributed as addenda or as replacement pages at the time the change is adopted. It shall be the responsibility of the Manual user to provide the City with a current address in order to receive written changes. Each manual user shall be responsible for notifying BPWD of any change in their mailing address. Revisions that are requested by users shall be accompanied by detailed comparative engineering data supporting the reasons and justifications for the requested change.

300.3.3 Design Requirements

The design criteria presented in the Stormwater management manual represent sound and customary engineering practices and should be utilized in the preparation of drainage plans, details, specifications and reports. The criteria are intended to establish guidelines, standards and methods that should be supplemented with sound planning and design.

The design criteria shall be revised and updated by BPWD as necessary to reflect advances in the field of drainage engineering, water resources management, and as water quality technologies and regulations change.

The City of Bryant and its staff will utilize the Manual in the planning of new facilities and in their reviews of proposed works by developers, private parties, and other governmental agencies, including those of the city.

The policy of BPWD shall be to require that point flows be discharged to downstream properties at non-erosive velocities and minimal depths of flow, and to maintain the flow of storm runoff within its natural drainage basin and path unless reasonable variation is demonstrated otherwise.

Where proposed improvements may be constructed, the City may, at its discretion require submittal of a master drainage plan study to ensure a coordinated and cohesive design of all phases of work.

300.3.4 Financial Responsibility

The City Stormwater Management Ordinance requires that all drainage structures be constructed in such locations and of such size and dimensions to adequately serve the subdivision or development and its contributing drainage area upon full build out. The developer shall be responsible for all costs for the development of the drainage system. The developer shall provide for all easements and rights-of-way that may be required for drainage structures including storm sewers, culverts, open or paved channels, and other drainage improvements, when requested by the City.

300.4 DESIGN POLICY

300.4.1 Qualifications

All drainage related plans shall be reviewed, sealed and signed by a Registered Professional Engineer with a current and valid license from the State of Arkansas. The Engineer shall attest that the design was conducted in accordance with the Stormwater management manual and in accordance with sound engineering practices.

300.4.2 Computations

Computations shall be submitted to BPWD for review and shall be prepared in accordance with the procedures, standards, and criteria of this Stormwater management manual.

300.4.3 Drainage Systems and Design Storm Frequencies

Drainage systems shall be designed to accommodate existing flows, as well as additional flow contributions that result from the proposed development. The frequency storm used in design shall be as follows:

- a. Bridges or culverts shall be provided where continuous streets or alleys cross water courses, and shall be designed to accommodate a 100-year storm, and meet Federal Emergency Management Agency (FEMA) Regulations on FEMA Regulated Floodways or Floodplains.
- b. A 50-year frequency storm shall be used for design, without overtopping on principle arterial roads and streets.
- c. A 25-year frequency storm shall be used for design, without overtopping minor arterial and collector roads and streets.
- d. A 10-year frequency storm shall be used for design, without overtopping all other roads and streets.
- e. A 10-year frequency storm shall be used to design private development except where conditions above apply.

The City Stormwater Management Ordinance requires all development to include planning, design, and construction in accordance with the Stormwater management manual.

There are many developed areas within The City of Bryant that do not conform to the drainage standards contained in this Manual. It is recognized that the upgrading of these developed areas to conform to all of the policy, criteria, and standards contained in the Manual will be difficult to attain, short of complete redevelopment or renewal. Therefore, in the planning of drainage improvements and the designation of floodplains for existing developed areas, the use of the criteria and standards contained in the Manual, or portions thereof, may be varied or waived as determined by the Administrative authority in accordance with established variance procedures.

300.4.4 Materials and Products

This section addresses storm drainage products and materials allowed within The City of Bryant. Arkansas Highway and Transportation Department (A.H.T.D.) specifications, current edition, shall apply except where otherwise stated within this section.

304.4.a Pipe Culverts and Storm Drainage Piping

This section covers all types of storm drainage pipe that is allowed within The City of Bryant. The materials, pipes, or appurtenances shall meet one or more of the following standards:

- 1. Allowable Sizes.** The minimum diameter pipe allowed is 15” for round and its equivalent for arched pipe.
- 2. Reinforced Concrete Pipe.** All reinforced concrete pipe shall be Class III or higher, unless otherwise noted on the plans, with bell and spigot or tongue and groove joints and conform to the requirements of the following latest editions of ASTM and AASHTO standards. Joints shall be sealed with compression type preformed rubber gaskets or bitumen/butyl rubber plastic gaskets.

- Reinforced concrete circular pipe shall be manufactured per ASTM C-76/AASHTO M-170 with a minimum B wall thickness.
- Reinforced concrete arched pipe shall be manufactured per ASTM C-506.
- Joints shall be sealed with either preformed rubber gaskets or bitumen butyl rubber plastic gaskets complying with AASHTO M-198.

3. Cast in Place/Precast Concrete Box Culverts. All cast in place concrete box culverts shall be manufactured per Section 802 (Concrete for Structures) and Section 804 (Reinforcing Steel for Structures) of the current A.H.T.D. Standard Specifications for Highway Construction. Precast concrete box culverts are allowed and shall be manufactured per Section 607 (Precast Reinforced Concrete Box Culverts) of the current A.H.T.D. Standard Specifications for Highway Construction.

4. Corrugated Metal Pipe and Arch Pipe. The use of metal pipe is discouraged within the jurisdiction of the City of Bryant. However, the use of metal pipe may be allowed upon approval by the City Engineer on a case by case basis. Metal pipe gauge shall be in accordance with A.H.T.D. Bedding and fill height requirements if allowed. If allowed by the City Engineer, the following metal pipe products and applicable specifications will be considered:

- Zinc Coated (Galvanized) Corrugated Steel Pipe shall be manufactured per AASHTO M36 and M 218.
- Aluminum Coated Corrugated Steel Pipe shall be manufactured per AASHTO M 36 and M 274.
- Aluminum-Zinc Alloy Coated Corrugated Steel Pipe shall be manufactured per AASHTO M 36 and AASHTO M 289.
- Corrugated Aluminum Pipe shall be manufactured per AASHTO M 196.
- Asphalt Coated Corrugated Metal Pipe shall be manufactured per AASHTO M 190, Type A.
- Polymer Precoated Metallic Coated Corrugated Steel Pipe shall be manufactured per AASHTO M 245. The metallic coating shall comply with the applicable requirements of AASHTO M 36 and AASHTO M 218, M 274 or M 289 for zinc, aluminum or aluminum-zinc alloy coating. The sheets shall have a polymeric coating of 0.010" minimum thickness on each side after corrugation.
- Polymer Pre-Coated Spiral Rib Metal Pipe Type 1R shall be manufactured per ASTM A 760. This is used for increased hydraulic performance and must have a manning's n value of 0.012. The spiral rib metal pipe shall be polymer coated inside and out with a protective polymer coating conforming to AASHTO M 246 or ASTM A 742. The polymer coating shall be a minimum of 10 mils thick. The polymer shall be composed of polyethylene and acrylic acid copolymer, labeled TRENCHCOAT protective film, or approved equal. Paved inverts are required in closed systems if the slope exceeds 2.0 percent and in open systems if the slope exceeds 1.5 percent or if severe abrasion is anticipated.

5. Polyethylene Pipe. The manufacture and furnishing of polyethylene pipe shall conform to AASHTO M 294 (sizes 12 inches – 24 inches) and ASTM D 2321, latest edition. Couplings and fittings supplied or recommended by the pipe manufacturer shall

be used. Factory installed bell and spigot joints with O-ring gaskets meeting ASTM F 477 are required. All polyethylene pipe shall have a corrugated outer shell with an essentially smooth wall waterway.

6. Not Listed Products. Other products and alternatives may be submitted to the City of Bryant City Engineer for review and consideration.

304.4.b Allowable Pipe Material Under Roadways and Drives

Cross Drains. A cross drain is defined as any pipe located beneath a City street. City streets are classified as principal arterials, minor arterials, collectors, and residential. Reinforced Concrete Pipe, Reinforced Concrete Arch Pipe and Reinforced Concrete Box Culvert are the only pipe materials authorized for cross drains.

Parallel (Side) Drains. A parallel or side drain is defined as any pipe located outside of the city's right of way not subject to traffic loads and any pipe within the city right of way not beneath a city street, for example driveways, landscape areas, or along lot lines. The City recommends the use of Reinforced Concrete Pipe in all applications in order to reduce the future maintenance costs associated with metal and plastic pipe. However all materials listed within Section 304.4. are authorized for parallel drains. However the City reserves the right to disallow any materials due to field conditions.

Principal and Minor Arterials. Reinforced Concrete Pipe, Reinforced Concrete Arch Pipe and Reinforced Concrete Box Culvert are the only pipe materials authorized under roadways classified as arterials.

Collectors. Reinforced Concrete Pipe, Reinforced Concrete Arch Pipe and Reinforced Concrete Box Culvert are the only pipe materials authorized under roadways classified as collectors.

Residential. Reinforced Concrete Pipe, Reinforced Concrete Arch Pipe and Reinforced Concrete Box Culvert are the only pipe materials authorized under roadways classified as residential.

Private Drives. The City recommends the use of Reinforced Concrete Pipe in all applications in order to reduce the future maintenance costs associated with metal and plastic pipe. However all materials listed within Section 304.4. are authorized for private drains. However, the City reserves the right to disallow any materials due to field conditions.

Closed Systems and Culverts. Pipe will be allowed per the cross drain or parallel drain application listed above whether a pipe is being used in a closed systems/network or in a culvert application.

304.4.c Cast in Place (Precast) Drop Inlets and Junction Boxes. This item shall consist of the construction of cast in place drop inlets, yard drains, junction boxes, and drop inlet extensions per the current Standard Specifications for Highway Construction of the Arkansas State Highway and Transportation Department. Precast concrete units may

be used in lieu of cast-in-place concrete units and shall be subject to the requirements of AASHTO M 199/ASTM C 478.

304.4.d Flared End Sections and Reinforced Concrete Headwalls. Flared end sections shall be of the same material as the culvert pipe for a given installation except that reinforced concrete flared end sections, zinc coated, aluminum coated, or aluminum-zinc alloy coated corrugated steel flared end sections may be used with any corrugated steel pipe. Reinforced concrete flared end sections for circular and arch shall comply with the applicable requirements for Class II or higher classes of pipe.

Precast headwalls and curtain walls are allowed in lieu of constructing cast in place curtain walls or headwalls.

304.4.e Stormwater Manhole Frames and Covers. Metal used in manufacture of municipal castings shall be ASTM A-48, Class 35B Gray Iron. Castings shall meet requirements of AASHTO M-306. Castings shall be manufactured true to pattern; component parts shall fit together in a satisfactory manner. They shall be of uniform quality, free from sand holes, shrinkage, cracks or other defects, and be smooth well cleaned by shot-blasting and furnished without paint. All circular manhole frames and covers shall be furnished with machined horizontal bearing surfaces. Manufacturer's shop drawing shall be submitted to the City Engineer for approval prior to the manufacture or shipment of castings. The City Engineer retains the right to reject castings not conforming to this specification. Manhole covers shall be furnished with markings as indicated in attached sample shop drawing (Exhibit 300-1). Manholes frames and covers shall be made in the U.S.A. Manhole frames and covers for in street traffic use shall be heavy duty. Manhole frames and covers for other than in street traffic shall be light duty.

300.4.5 Hydrologic Analysis

The determination of peak runoff magnitude shall be accomplished using either the Rational Method, Soil Conservation Service methods, HEC-1, HEC-HMS or other computer modeling techniques and accepted methods approved by the City of Bryant City Engineer. When using HEC-1, the SCS Unit Hydrograph option is preferred.

300.4.5.1 Areas Under 200 Acres

Design peak discharges for the design and for major storm drainage systems for areas less than 200 acres should be computed using the Rational Method.

300.4.5.2 Areas Over 200 Acres

Design peak discharges for areas over 200 acres shall be computed using the Soil Conservation Service methods, HEC-1, HEC-HMS or other approved computer modeling programs. These methods shall be used for designing both the design and major storm drainage systems.

Where hydrographs are needed for flood routing through detention basins and through major drainage systems, they shall be computed using HEC-1, HEC-HMS, SCS TR-20, or another hydrograph modeling technique approved by the City of Bryant City Engineer.

300.4.6 Accuracy

The peak discharges determined by analytical methods are approximations. The drainage system will rarely operate at the design discharge. Flow will always be more or less in actual practice, merely passing through the design flow as it rises and falls. Thus, the engineer should not overemphasize the accuracy of his computed discharges. The Engineer should apply a reasonable factor of safety while emphasizing the design of a practical and hydraulically balanced system, which is based on sound logic and engineering.

300.4.7 Computer Models

A variety of computer models are available for hydrologic and hydraulic analyses. Approval of the City Engineer must be obtained prior to using models other than those specifically identified in this Stormwater management manual. Requests to use an alternative computer model must be submitted in writing to the City Engineer. The request must describe the methodology that would be employed by the alternative computer model, and evidence justifying its use. The City Engineer shall be the final authority and approve or disapprove the use of the alternative computer model. If approved, the most recent version of the proposed model must be used.

It is the responsibility of the developer to obtain the most recent stream hydraulic model and incorporate any modifications that are proposed as part of a development. Updated stream hydraulic models reflecting proposed conditions must be submitted to both, the Federal Emergency Management Agency (FEMA) and BPWD for approval.

300.4.8 Open Drainage Channels

Open channels for conveyance of storm water runoff can be desirable and use of such channels may be considered as a possible option. Consideration should be given to the floodplains and open space requirements of the area.

Natural watercourses, perhaps wet only during and after large rainstorms, generally should not be filled, straightened, or altered significantly. Channelizing a natural waterway tends to reduce natural storage, increase flow velocity and cause higher downstream peaks, often to the detriment of those downstream as well as those adjacent to the channel. Effort must be made to reduce flood peaks and control erosion so that the natural channel is preserved. Therefore, drainage designs, which include new or reconstructed drainage channels should be carefully weighed against the environmental and financial considerations of maintaining a natural drainage way.

Open channels should generally follow the natural flowlines and should receive early attention in planning stages of a new development, along with other storm runoff

features. Optimal benefits from open channels can often be obtained by incorporating greenbelts along the channel.

Open channels shall be designed such that flow is contained within channel banks for the 25-year storm. The lowest finished floor elevation of residential dwellings; or public, commercial and industrial buildings shall be no less than one (1) foot above the level of inundation for the major storm event (100-year storm) unless the building is flood-proofed.

A dedicated maintenance easement shall be provided with all drainage channels when requested by the City. This easement, when requested, shall provide a minimum access width of 20 feet outside both channel bank(s). This easement may be split between drainage channel sides but one side (easement) shall be no less than 15 feet in width and the total easement shall be no less than 25 feet in width unless access and maintenance provisions are provided by other dedicated right-of-way. These dedicated maintenance easements shall be sufficiently cleared and graded to allow easy access by maintenance equipment.

300.4.9 Tailwater

The depth of flow in the receiving drainage way must be taken into consideration for backwater computations for both the design and major storm runoff. Backwater computations shall assume a starting elevation greater than or equal to the same return period as the design and major storms, assuming a fully developed watershed.

300.4.10 Coordination of Planning Efforts

The planning for drainage facilities should be coordinated with planning for open space, transportation, utilities, recreation and solid waste collection. By coordinating these efforts, new opportunities can be identified which will assist in the solution of drainage problems. The planning of drainage works in coordination with other needs results in more orderly development and lower cost.

Open space may provide significant social benefits. Use of natural drainage ways is often less costly than constructing and maintaining artificial channels. Combining the open space needs of a community with major drainage ways can be a desirable conjunctive use.

The design and construction of new streets, alleys and highways should be fully integrated with drainage needs of the area to promote efficient drainage and avoid the creation of flooding hazards.

300.4.11 Use of Streets and Alleys

Streets are significant and important in drainage and shall be used for storm runoff up to reasonable limits, while recognizing that the primary purpose of streets is for traffic. Limits of the use of streets for conveying storm runoff shall be governed by the design criteria in Table 300-1, below.

TABLE 300-1 Design Storm Runoff Allowable Street Use

Street Classification	Design Storm	Maximum Pavement Encroachment
Residential Street	10 year	Flow of water in gutters shall be limited to a flow at the curb of six (6) inches or wherever the street is just covered, whichever is the least depth.
Residential Collector Streets	25 year	Flow of water in gutters of a residential collector street shall be limited so that one standard lane will remain clear.
Industrial and Arterial Streets	50 year	Flow of water in gutters of industrial and arterial streets shall be limited so that two standard lanes will remain clear (at least one lane in each direction)

When the above maximum encroachment is reached, a separate storm drainage system or additional storm drainage capacity shall be provided, designed on the basis of the design storm. However, construction of the major drainage system is encouraged to quickly drain the design storm runoff from the street.

While it is the intent of this policy to have major storm runoff removed from public streets into major drainage ways at frequent and regular intervals, it is recognized that water will often tend to follow streets and roadways. Therefore, streets and roadways often may be aligned so that they will provide a specific runoff conveyance function.

The allowable flow across streets shall be limited within the criteria shown in Table 300-2.

TABLE 300-2 Allowable Cross Street Flow

Street Classification	Design Storm Runoff	Major Storm Runoff
Residential Street	6 inches of depth in valley gutter	12 inches of depth in valley gutter
Collector, Industrial and Arterial Streets	None	6 inches or less over

In general, collector and arterial street crossings will require installation of a storm drain system or other suitable means to transport the design storm runoff along and underneath the street. Cross valley gutters shall be discouraged and used only at infrequent locations on residential streets only when approved by the City Engineer.

Lowering of the standard height of street crown shall not be allowed for the purposes of hydraulic design, unless approved by the City Engineer. In no case will reduced crowns be allowed on arterial streets.

Where additional hydraulic capacity is required on a street, the gradient must be increased and/or inlets and storm drains or other storm water conveyance facilities shall be installed to remove the required portion of the flow.

Alleys are not an integral part of the drainage system. In general, alleys shall be designed to convey only the runoff from the rear of adjacent lots and direct it to the street at the end of the block. In no case shall runoff in any street be directed to flow into an alley or an alley be used as a drainage way, unless approved by BPWD.

300.4.12 Floodplain Management

The foremost goal of many successful businesses is to obtain the greatest return for the least cost. When applied to land development, this goal translates into obtaining the largest developable land area using the most economic development measures. Thus, existing floodplain land becomes more valuable if the land can be removed from the floodplain for development. The purpose of floodplain management is to provide the guidance, conditions, and restrictions for development in floodplain areas while protecting the public's health, safety, welfare, and property from flood hazards.

To provide impetus for proper floodplain management, the United States government, acting through FEMA's National Flood Insurance Program (NFIP), has established regulations for development in floodplain areas. Compliance with those regulations allow property owners to obtain lower cost flood insurance premiums, and/or eliminates the requirement for the owner to obtain flood insurance as a condition for obtaining government supported loans. Therefore, there is a benefit to the citizens of The City of Bryant for remaining in compliance with the NFIP's regulations.

General guidance, conditions, and restrictions for development in floodplain areas are presented in this Stormwater management manual and are to be used in conjunction with FEMA regulations to meet the above stated floodplain management objectives.

The policy of the BPWD shall be to regulate floodplains in accordance with the City's adopted uniform regulations for the control of drainage, as well as the regulations of the NFIP.

Since FEMA policies can change, their regulations are not specifically cited in this Stormwater management manual. It is incumbent upon the local engineering community to keep abreast of FEMA's current regulations. FEMA has adopted the 100-year flood (1

percent chance of annual occurrence) as the base flood for floodplain management purposes and delineates the 100-year floodplain on their maps. For certain stream courses studied by FEMA, by detailed methods, a floodway may also be depicted. The floodway is a portion of the floodplain and is defined as the channel itself plus any adjacent land areas, which must be kept free of encroachment in order to pass the base flood without increasing water surface elevations by more than a designated height. The following subsections discuss in general some terms and issues relative to FEMA's regulations.

300.4.12a FEMA National Flood Insurance Program

The City of Bryant is a participant in the National Flood Insurance Program (NFIP). The Federal Emergency Management Agency (FEMA) administers the NFIP, which enables property owners to purchase flood insurance at a reduced cost. In return for making subsidized flood insurance available for existing structures, The City of Bryant has agreed to regulate new development in Special Flood Hazard Areas (SFHA). These SFHA are areas that have special flood, mudslide and/or flood-related erosion hazards. Those regulations have been adopted in the form of a floodplain ordinance.

FEMA publishes Flood Hazard Boundary Maps (FHBM) and Flood Insurance Rate Maps (FIRM) showing communities flood hazard areas and the degree of risk in those areas. An FHBM is based on approximate data and identifies, in general, the Special Flood Hazard Areas within a community. FHBM's are used for floodplain management and insurance purposes. When a detailed Flood Insurance Study has been conducted the FIRM will show base flood elevations, insurance risk zones and flood plain boundaries, and may show the floodway delineated. The City of Bryant requires the finished floor elevation of any structure constructed within a floodplain be 2 feet above the base flood elevation (BFE).

If a flood map is believed to be incorrect, three procedures have been established to change or correct a flood map. They include: 1) Letter of Map Amendment (LOMA); 2) Letter of Map Revision (LOMR), and 3) Physical map revision. A LOMA results from a technical data or scientific data review submitted by the owner who believes his/her property has been incorrectly included in a designated Special Flood Hazard Area. A LOMR is used to change flood zones, flood delineations, flood elevations, and planimetric features. A LOMR is an amendment to the effective FEMA map and is usually followed by a physical map revision. A physical map revision is an official republication of a map to effect changes to flood insurance zones, floodplain delineations, flood elevations, floodways, and planimetric features.

300.4.12b FEMA Map Revisions and Amendments

FEMA has a number of different procedures for requesting changes to their Flood Insurance Rate Maps (FIRMs). Since the FIRMs for The City of Bryant are effective (dated February 11, 1991), changes to them are handled either as a Letter of Map Revision (LOMR), Letter of Map Amendment (LOMA), or publication of a revised map, also known as a "physical map revision" (PMR). FEMA may issue a conditional letter of map revision (CLOMR or CLOMA) if the request is based on a proposed project. If

exclusion from a Special Flood Hazard Area (SFHA) is due to elevating a structure on fill, the map revision is designated LOMR-F or CLOMR-F.

Any change to the Special Flood Hazard Information is handled as a map revision. These changes can include changes to floodplain boundaries, floodway boundaries, flood insurance risk zones, base flood elevations, flood depths, and other information shown on the maps. All changes must be based on existing conditions, although a conditional determination may be requested for proposed projects, such as modifications to stream channels and floodplains, and proposed elevation on fill of structures or parcels of land.

Due to the scale of FEMA's maps, individual structures or legally described parcels of land may be inadvertently included in a SFHA. Excluding an individual structure or parcel of land from the SFHA is handled as a map amendment. The map amendment process is not applicable to requests involving changes to Special Flood Hazard Information on the maps and cannot be based on new topography or hydrologic or hydraulic conditions. The following subsections briefly discuss the various types of map revisions and amendments and how to request them. More detailed information is available from the City of Bryant Floodplain Administrator's Office.

300.4.12c Map Revisions

Any information on FEMA's FIRMS may be changed, subject to FEMA review and concurrence. However, FEMA generally only revises effective maps if changes affect 100-year flood information. Map revisions can either be a PMR or LOMR. In general, FEMA only processes PMRs only when changes involve a large area of land or increased flood risk. Otherwise, LOMRs are issued if changes involve small areas within a community.

In the City of Bryant, the BPWD and the individual city agencies are responsible for ensuring all obligations are met to allow the City to participate in the NFIP. Although private parties may request a map revision, it is strongly suggested that such requests be submitted or coordinated with BPWD. If FEMA receives any map revision requests in The City of Bryant from a private party without the concurrence of BPWD, the requestor will be asked for evidence that the request was first submitted to BPWD.

Map revisions typically fall into three categories - those based on the effects of physical changes in the floodplain, those based on the use of better data, and those based on the use of alternative methodology.

If a structure or parcel of land is elevated on fill, a map revision may be issued to remove the structure from a SFHA if both the lowest adjacent grade to the structure and the lowest floor are at or above the base flood elevation (BFE) or when the placement of fill has elevated a legally-defined parcel of land at or above the BFE. Requests for such map revisions are called LOMR-F or CLOMR-F, depending on whether the structure is existing or proposed.

Because each request for a map revision is unique, the required forms, supporting data, and submittal fees vary widely. Requestors should contact BPWD for a FEMA

Application/Certification Forms and Instructions for Amendments and Revisions to National Flood Insurance Program Maps.

300.4.12d Map Amendments

Typically, the scale of FEMA's maps does not allow the floodplain delineations to be shown in the detail required to precisely determine whether an individual structure or legally described parcel is within the SFHA. Similarly, existing small areas of high ground may be shown within the SFHA because they are too small to be shown to scale. FEMA has developed the map amendment process to allow property owners or lessees to request that FEMA determine whether a specific structure or parcel is in the SFHA and, if necessary, issue a Letter of Map Amendment.

It is important to note that a LOMA should only be requested on the basis of an inadvertent inclusion in the SFHA and not due to recent alterations of topography or significant changes to the flooding information shown on the FEMA map. In either of these cases, the request should be submitted as a map revision rather than a map amendment.

Although less common than conditional map revisions, a conditional map amendment (CLOMA) can be requested if an individual intends to build a structure(s) on a single or multiple lots, but not on fill, and wants FEMA to determine whether the structure will be excluded from the SFHA shown on the effective maps.

As with map revisions, because each request for a map amendment is unique the required forms, supporting data, and submittal fees vary widely. Requestors should contact BPWD for a FEMA Application/Certification Forms for Amendments and Revisions to National Flood Insurance Program Maps.

300.4.12 e Levee Freeboard Criteria

If a flood control levee is proposed within a FEMA SFHA and a map revision will be requested based on the levee providing protection against the 100-year flood, FEMA's levee criteria shall be used in order for FEMA to credit the levee. It is noted that FEMA's levee policy requires that the levee be maintained by a governmental agency and certified according to the Code of Federal Regulations in order to be recognized as providing flood protection. Therefore, any levees in FEMA 100-year SFHAs shall be coordinated with the local jurisdiction and BPWD.

Local levees are those, which are not maintained by a governmental agency. For local levees, freeboard shall be provided per this Stormwater management manual. A sediment study shall also be performed per this Stormwater management manual. Non-erosive velocities shall be maintained, or erosion protection shall be provided to ensure the integrity of the levee during storm events.

300.4.12 f Vertical Control (NGVD 29 vs. NAVD 88)

The base flood elevations and elevation reference marks on the current FEMA Flood Insurance Rate Maps for The City of Bryant are based on the National Geodetic Vertical Datum of 1929 (NGVD 29). The National Geodetic Survey has determined that the national vertical control network needs to be readjusted and FEMA is in the process of converting all National Flood Insurance Program maps to the new national datum, called the North American Vertical Datum of 1988 (NAVD 88). In addition, the BPWD, has based the official The City of Bryant Vertical Control on NAVD 88 and requires that all new maps, plans, reports, and other documents submitted for review to reflect elevations referenced to NAVD 88.

However, FEMA requires that requests for map revisions and amendments use the reference datum on the applicable, effective FIRM map, which, in The City of Bryant, is NGVD 29. Therefore, as of publishing, actual work should be done in NAVD 88 and a conversion factor to NGVD 29 should accompany any submittal to FEMA.

Additional information regarding the conversion from NGVD 29 to NAVD 88 may be available from BPWD.

300.4.13 Erosion and Sediment Control

The need for sediment and erosion control facilities, either permanent or temporary, shall be determined according to the standards for sediment and erosion control in developing areas as stated in this Stormwater management manual and in accordance with Arkansas Department of Environmental Quality regulations. Any temporary erosion and sedimentation control facilities shall be constructed prior to any grading or extensive land clearing. These facilities must be maintained until construction and landscaping are completed and the potential for significant erosion has passed.

Refer to Section 1100 of this manual for additional information related to erosion and sediment control.

300.4.14 Storm Water Transfer

Planning and design of storm drainage systems should not result in the transfer of drainage problems from one location to another. Channel modifications, which create or increase flooding downstream will not be allowed, both for the benefit of the public and to prevent damage to private parties. Erosion and downstream sediment deposition increase of runoff peaks, and debris transportation will not be allowed.

The subdivision development process can significantly alter historical or natural drainage paths. When these alterations result in a subdivision outfall system that discharges back into the natural drainage way at or near the historical location, the alterations are generally acceptable.

Master planning must be based upon potential future upstream development as determined or predicted by the City Engineer.

The policy of the City is to avoid transfer of storm drainage runoff from one drainage basin to another, and to maintain historical drainage paths. However, the transfer of drainage from one basin to another is a viable alternative in certain instances and will be considered on a case by case basis.

300.4.15 Detention and Retention

The policy of BPWD shall be to minimize the increase in the rate of flow from developing properties unless down stream facilities exist to accommodate the increased flow rates without adverse effects. Storm water runoff volume increases shall be stored in detention and retention facilities. Such storage reduces the drainage capacity required, thereby reducing the land area and expenditures required downstream. Multipurpose utilization of such storage areas is encouraged. Detention/retention basins shall be analyzed both individually and as a system to assure compatibility with one another and coordinated with the City's overall Storm Water Management Master Planning.

Storage of storm water runoff close to the points of rainfall occurrence such as the use of parking lots, ball fields, property line swales, parks, road embankments, borrow pits and on-site ponds is desirable and encouraged.

Parking lots, such as at shopping centers, create rapid runoff with high discharge rates. Parking lots should provide for temporary storage of runoff except where such storage creates excessive depth or is impractical. Wherever reasonably acceptable, parks should be used for short-term detention of storm runoff to create drainage benefits.

Refer to Section 1000 of this manual for additional information related to stormwater detention storage.

300.4.16 Storm Water Runoff Quality

The policy of The City of Bryant is to include water quality considerations in the design of storm drainage facilities. It is desirable to remove sediment, debris, and other pollutants from storm water runoff where practical, and the City encourages implementation of measures to reduce the pollutant load in storm water runoff. The City of Bryant is required to obtain and administer a National Pollutant Discharge Elimination System (NPDES) general permit. Federal regulations require the City to obtain a general permit, and storm water drainage facilities are required to be in compliance with the City's permit. The City of Bryant policy will be updated as needed to comply with future federal regulatory requirements as necessary.

Current Environmental Protection Agency (EPA) regulations require that new developments or construction activity that will disturb an area (1) acre and greater obtain a general NPDES permit for construction activity. The NPDES program in Arkansas is administered by the Arkansas Department of Environmental Quality (ADEQ). Additional information on the NPDES program can be obtained at the address listed below:

Arkansas Department of Environmental Quality
Attn: Ms. Kim Fuller, NPDES Branch
P.O. Box 8913
Little Rock, Arkansas 72219
(501) 682-2199

300.4.17 Stormwater Management Requirements

Refer to Section 200 of this manual.

300.4.18 Operations and Maintenance

Operation and maintenance of storm water facilities is required to ensure that they will perform efficiently and as designed. Channel BPWD and bank erosion, drop structures, pipe inlets and outlets, pumping facilities and overall condition of the facilities shall be routinely inspected and repaired as necessary to avoid reduced conveyance capacity, displeasing aesthetics and ultimate failure. Sediment and debris shall be periodically removed from channels, storm drains, detention basins and retention basins. Trash racks and inlets shall also be routinely cleared of debris to maintain system capacity.

The developer shall provide for perpetual maintenance of private drainage facilities. Private drainage facilities are those drainage improvements, which remain on private property and have not been officially accepted by the City for ownership and maintenance. The City will provide for perpetual maintenance of public drainage facilities after expiration of the warranty period.

The City Stormwater Management Ordinance requires that access be provided to all storm water facilities for maintenance and inspection. Developers shall be responsible for providing system features to facilitate maintenance of drainage systems, including inlets, pipes, culverts, channels, ditches, detention and retention basins.

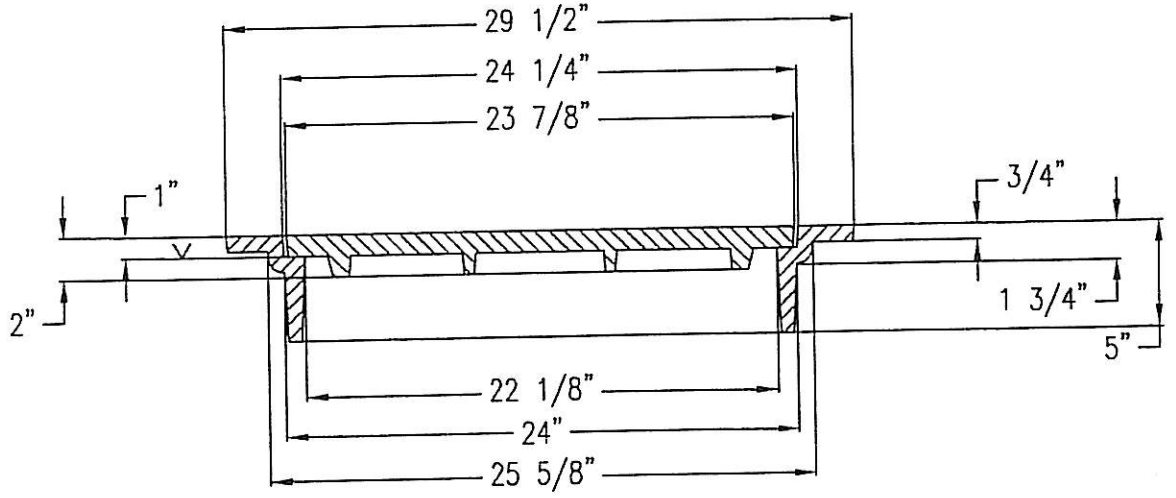
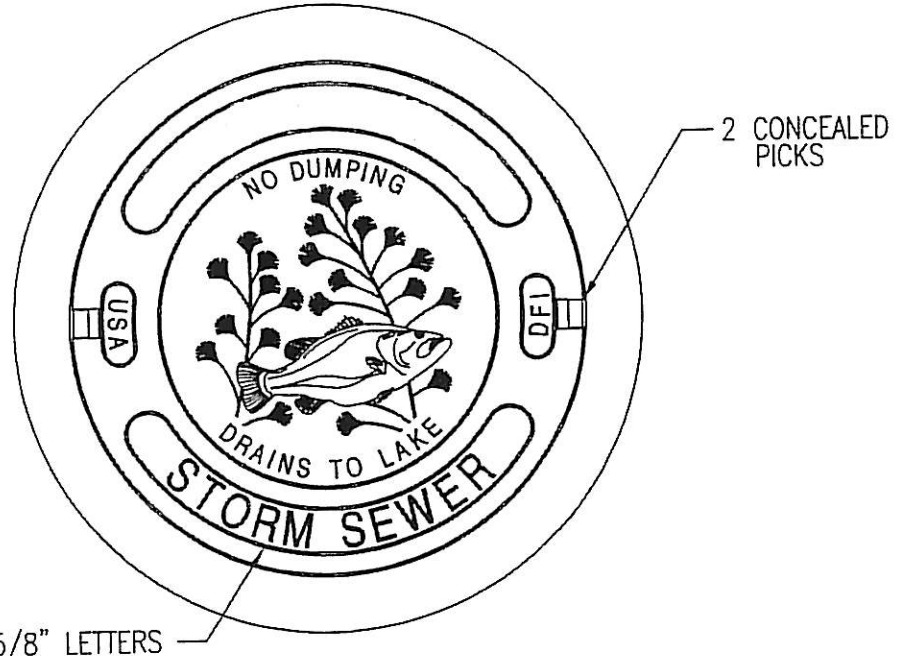

NOTE:
1. FURNISHED WITH MACHINED HORIZONTAL BEARING SURFACES.

CAD DWG. REF: 2018A-165/AYER: ALL SCALE: 1:25

MATERIAL:	CAST GRAY IRON ASTM A-48, CLASS 35B
FINISH:	NO PAINT
WEIGHT:	COVER 140 LBS. FRAME 133 LBS.

	Deeter Foundry, Inc.		
	5945 NORTH 70th STREET LINCOLN, NEBRASKA 68529		
#	2018-A	MANHOLE RING & COVER	
Date:	14 MAY 02	Drawn by:	KRH
Scale:			1/8
DRAWING NO.	02-2018A-	Revised by:	Date:

Exhibit 300-1 (Source Deeter Foundry Catalog)

**SECTION 400
STORM WATER RUNOFF**

	<u>Page</u>
400.1 INTRODUCTION	52
400.2 RATIONAL METHOD	52-61
400.3 SOIL CONSERVATION SERVICE METHODS	61-71
400.4 HYDROLOGIC MODELS	71
400.5 COMPUTERIZED HYDROLOGIC ANALYSIS PACKAGES	72
400.6 HEC-1 MODEL	72-73
400.7 HEC-HMS	73
400.8 HYDROLOGIC ENGINEERING CENTER (HEC)	73-75
EXHIBITS	76-88

SECTION 400 STORM WATER RUNOFF

400.1 INTRODUCTION

The primary objective of this section is to describe how a hydrologic model can be used to develop peak discharge-frequency estimates for a watershed. The hydrologist can use the material presented herein to help choose the appropriate level and detail of a study, based on the availability of the data, time and funds available, and the accuracy requirements of the study results. Any available data for the basin should be used in the calibration of the hydrologic model and in the development of discharge-frequency curves at gaged locations. By using all the resources available, including data from regional sources such as the United States Geological Survey in conjunction with the analytical techniques described herein, the hydrologist can usually make reasonable determinations of discharge-frequency relations for un-gauged basins. This section presents guidelines and methods for determining storm runoff for watersheds within all areas of The City of Bryant. It describes the method used for determining storm runoff from watersheds of less than 200 acres. It then briefly describes hydrologic models, which can be used on watersheds greater than 200 acres. There are several methods for determining the appropriate storm runoff from a watershed. The Rational Method may be used as the primary tool for the determination of peak storm water runoff rates from areas 200 acres or less and is especially useful for the design of storm sewer systems. In instances where detention is modeled, a hydrograph producing method is required, such as the Soil Conservation Service Tabular Method, TR-20, or HEC-1. The most extensively used methodology for computing runoff hydrographs is based on the Soil Conservation Service (SCS) Unit Hydrograph procedures. These procedures are used to quantify the effects of urbanization, to determine peak flows for large drainage areas, and to design storm water storage facilities. The SCS Unit Hydrograph Method is used and accepted nationwide. The presentation of these methods is not intended to preclude the use of other methods. However, the designer shall secure approval from the City Engineer before utilizing different methods. A written request to use an alternative method must be submitted to the City Engineer and approved prior to its use for a specific case. The request must describe the methods to be employed by the designer and present evidence justifying its use rather than the methods specifically identified in the Stormwater management manual.

400.2 RATIONAL METHOD

The Rational Method is an empirical runoff formula, which has gained wide acceptance because of its simple intuitive treatment of peak storm runoff rates in areas less than 200 acres. This method relates runoff to rainfall intensity, surface area and surface characteristics by the formula:

$$Q = C i A \quad (400-1)$$

where:

Q = peak runoff rate, in cubic feet per second (cfs)

- C = runoff coefficient
- i = average rainfall intensity, for a duration equal to the time of concentration, in inches per hour
- A = drainage area of the tributary to the point under consideration, in acres

The Rational Method is based on the following assumptions:

- A. The peak rate of runoff at any point is a direct function of the average uniform rainfall intensity during the time of concentration to that point.
- B. The frequency of the peak discharge is the same as the frequency of the average rainfall intensity.
- C. The time of concentration is the time required for the runoff to become established and flow from the most hydraulically remote part of the drainage area to the point under design. This assumption applies to the most remote in time, not necessarily in distance.

Although the basic principles of the Rational Method apply to drainage areas greater than 200 acres, practice generally limits its use to some maximum area. For larger areas, storage and subsurface drainage flow cause an attenuation of the runoff hydrograph so that the rates of flow tend to be overestimated by the Rational Method. In addition, the assumption of uniform rainfall distribution and intensity becomes less appropriate as drainage area increases. Because of the trend for overestimation of flows and the additional cost in drainage facilities associated with this overestimation, the application of a more sophisticated runoff computation technique is usually warranted for larger drainage areas.

400.2.1 Runoff Coefficient, C

The runoff coefficient, C, is a variable of the Rational Method which is least susceptible to a precise determination and provides the designer with a degree of latitude to exercise his independent judgment. The following discussion is intended to provide a guide to promote the uniform application of runoff coefficients.

The runoff coefficient, C, accounts for abstractions for losses between rainfall and runoff which may vary with time for a given drainage area. These losses are caused by interception by vegetation, infiltration into permeable soils, retention in surface depressions, and evaporation and transpiration.

Table 400-1 presents C values that shall be used for various land use types. It is often desirable to develop a composite runoff coefficient based in part on the percentage of different types of surfaces in the drainage area. This procedure can be applied to typical "sample" areas as a guide to the selection of usual values of the coefficient for the entire area. Suggested runoff coefficients with respect to surface types are given in Table 400-2.

Runoff Coefficients

Land Use Types	Frequency		
	10	25	100
<u>Business</u>			
Central Business District	0.9	0.93	0.95
Commercial Area	.85 (.70-.95)*	0.9	0.95
Neighborhood Area	.70 (.50-.75)	0.75	0.8
<u>Residential</u>			
Single Family	.50 (.30-.60)	0.6	0.7
Multi-Unit (Detached)	.60 (.40-.65)	0.65	0.75
Multi-Unit (Attached)	.70 (.60-.75)	0.75	0.8
½ Acre Lots or Larger	.40 (.25-.50)	0.45	0.65
Apartments	.70 (.50-.80)	0.75	0.8
<u>Industrial</u>			
Light Areas	.80 (.50-.85)	0.82	0.85
Heavy Areas	.85 (.60-.90)	0.87	0.9
<u>Miscellaneous</u>			
Parks and Cemeteries	.30 (.10-.40)	0.4	0.6
Playgrounds	.35 (.20-.40)	0.5	0.7
Schools and Churches	.60 (.50-.75)	0.65	0.75
Railroad Yards	.50 (.30-.60)	0.6	0.7
Offsite Flow Analysis (When Land Use Not Defined)	.55 (.45-.65)	0.67	0.7

*NOTE: The range of runoff coefficients is based on soil surface types. The low value is for sandy soils, while the high value is for clay soils. The given runoff coefficient outside the parenthesis is to be used for design, unless the Engineer of Record receives approval from the City Engineer for another value located within the given coefficient range.

Source: City of Little Rock Stormwater Management & Drainage Design Manual

TABLE 400-1

Runoff Coefficients for Surface Types

Character of Surface	Return Period					
	2-yr	5-yr	10-yr	25-yr	50-yr	100-yr
Developed						
Asphaltic	0.73	0.77	0.81	0.86	0.90	0.95
Concrete/Roof	0.75	0.80	0.83	0.88	0.92	0.97
Grass Areas (Lawns, Parks, etc.)						
Poor Condition (grass cover less than 50 percent of the area)						
Flat, 0-2%	0.32	0.34	0.37	0.40	0.44	0.47
Average, 2-7%	0.37	0.40	0.43	0.46	0.49	0.53
Steep, Over 7%	0.40	0.43	0.45	0.49	0.52	0.55
Fair Condition (grass cover on 50 to 75 percent of the area)						
Flat, 0-2%	0.25	0.28	0.30	0.34	0.37	0.41
Average, 2-7%	0.33	0.36	0.38	0.42	0.45	0.49
Steep, Over 7%	0.37	0.40	0.42	0.46	0.49	0.53
Good Condition (grass cover larger than 75 percent of the area)						
Flat, 0-2%	0.21	0.23	0.25	0.29	0.32	0.36
Average, 2-7%	0.29	0.32	0.35	0.39	0.42	0.46
Steep, Over 7%	0.34	0.37	0.40	0.44	0.47	0.51
Undeveloped						
Cultivated Land						
Flat, 0-2%	0.31	0.34	0.36	0.40	0.43	0.47
Average, 2-7%	0.35	0.38	0.41	0.44	0.48	0.51
Steep, Over 7%	0.39	0.42	0.44	0.48	0.51	0.54
Pasture/Range						
Flat, 0-2%	0.25	0.28	0.30	0.34	0.37	0.41
Average, 2-7%	0.33	0.36	0.38	0.42	0.45	0.49
Steep, Over 7%	0.37	0.40	0.42	0.46	0.49	0.53
Forest/Woodlands						
Flat, 0-2%	0.22	0.25	0.28	0.31	0.35	0.39
Average, 2-7%	0.31	0.34	0.36	0.40	0.43	0.47
Steep, Over 7%	0.35	0.39	0.41	0.45	0.48	0.52

Source: Rossmiller, R.L. "The Raional Formula Revisited."
County of Austin Drainage Criteria Manual

TABLE 400-2

Runoff Coefficients for Rational Method Composite Analysis

Land Use Types	Frequency		
	10	25	100
<u>Undeveloped Areas</u>			
Historic Flow Analysis, Greenbelts Agricultural, Natural Vegetation			
<u>Clay Soil</u>			
Flat, 2%	0.3	0.33	0.37
Average, 2-7%	0.4	0.44	0.5
Steep, 7%	0.5	0.55	0.62
<u>Sandy Soil</u>			
Flat, 2%	0.12	0.13	0.15
Average, 2-7%	0.2	0.22	0.25
Steep, 7%	0.3	0.33	0.37
<u>Streets</u>			
Paved	0.9	0.92	0.95
Gravel	0.35	0.5	0.65
<u>Miscellaneous</u>			
Drives and Walks	0.9	0.91	0.92
Roofs	0.9	0.92	0.95
Lawns			
<u>Clay Soil</u>			
Flat, 2%	0.18	0.2	0.25
Average, 2-7%	0.22	0.28	0.35
Steep, 7%	0.35	0.45	0.6
<u>Sandy Soil</u>			
Flat, 2%	0.1	0.25	0.4
Average, 2-7%	0.15	0.3	0.45
Steep, 7%	0.2	0.35	0.5

Source: City of Little Rock Stormwater Management & Drainage Design Manual

TABLE 400-2 (cont.)

The design engineer shall use the preceding values as a rule of thumb. Areas not conforming to the preceding descriptions will be evaluated by calculating a composite runoff coefficient. Areas will be evaluated based upon the ultimate development.

400.2.2 Rainfall Intensity, i

Rainfall intensity, i , is the average rate of rainfall in inches per hour. Intensity is selected on the basis of design frequency of occurrence, a statistical parameter established by design criteria, and rainfall duration. For the Rational Method, the critical rainfall intensity is the rainfall having a duration equal to the time of concentration of the drainage basin. Rainfall intensity can be determined for the 2-, 5-, 10-, 25-, 50- and 100-year return periods from Exhibit 400-1 and 400-2 (see back of this chapter) for durations from five minutes to 24 hours. The curves in Exhibit 400-1 are applicable for design frequencies up to a 100-year storm and for durations expressed in minutes, while Exhibit 400-2 presents the duration in hours.

400.2.2.a Time of Concentration, t_c

The time of concentration used in the rational method is a measure of the time of travel required for runoff to reach the design point or the point under consideration. The critical time of concentration is the time to the peak of the runoff hydrograph at the design point. Runoff from a watershed usually reaches a peak at the time when the entire watershed area is contributing to flow. The critical time of concentration, therefore, is the flow time measured from the most remote part of the watershed to the design point. A trial and error procedure is usually required to select a most remote point of a watershed since type of flow, ground slopes, soil types, surface treatments and improved conveyances all effect flow velocity and time of flow. There are two types of flow used in calculating the design time of concentration; overland flow and channelized flow. Overland flow is defined as that portion of the flow pattern which results in thin sheet flow across a given area. Channelized flow is that which allows significant depth accumulation either in a swale, ditch, natural channel, improved channel or pipe system.

Exhibit 400-3 (see back of this chapter) can be used for time of concentration computations. The known ground slope plus the type of surface treatment is used to determine the time of concentration in minutes for both sheet and channelized flow. Overland flow distances will rarely exceed 400 feet in developed areas. If the overland flow time is calculated to be in excess of 20 minutes, the designer should check to be sure that the time is reasonable considering the projected ultimate development of the area.

One of the basic assumptions underlying the Rational Method is that runoff is a function of the average rainfall rate during the time of concentration. The time of concentration, t_c , is defined as the time it takes for runoff to become established and flow from the most hydraulically remote part of the drainage area to the point of reference. It is usually computed by determining the water travel time through the watershed. Overland flow or shallow concentrated flow, storm drain or road gutter flow, and channel flow are the three phases of direct flow commonly used in computing travel time. For urban areas, the time of concentration consists of an inlet time or overland flow time (t_i) plus the travel time (t_t) in the storm drain, paved gutter, roadside drainage ditch, or drainage channel. For non-

urban areas, the time of concentration consists of an overland flow time (t_i) plus the time of travel (t_t) in a combined form, such as a small swale, channel, or drainage way. The travel portion (t_t) of the time of concentration can be estimated from the hydraulic properties of the storm sewer, gutter, swale, ditch, or drainage way. Inlet time, on the other hand, will vary with surface slope, depression storage, surface cover, antecedent rainfall, and infiltration capacity of the soil, as well as distance of surface flow. The time of concentration can be represented by Equation 400-2 for both urban and non-urban areas.

$$t_c = t_i + t_t \quad (400-2)$$

where:

- t_c = time of concentration, in minutes
- t_i = initial, inlet, or overland flow time, in minutes
- t_t = travel time in the ditch, channel, gutter, or storm sewer, in minutes

400.2.2.b Overland Flow

The travel time for overland flow consists of the time it takes water to travel from the uppermost part of the watershed to a defined channel or inlet of the storm sewer system. Overland flow is significant in small drainage areas because a high proportion of travel time is due to overland flow. The velocity of overland flow can vary greatly with the surface cover and tillage. If the slope and land use of the overland flow segment are known, the travel time can be calculated using Equation 400-3.

The Kerby Equation is used to compute t_i for overland flow only. If channelized flow occurs in the sub-basin area, other methods must be used to determine the flow time in the channel.

The addition of these two flow times will provide the inlet time of concentration. The Kerby Equation is as follows:

$$t_i = 0.83 \frac{[NL]^{0.467}}{[S^{0.5}]} \quad (400-3)$$

where:

- t_i = time of concentration, in minutes
- N = coefficient of roughness, Table 400-3
- L = length, in feet, measured from the extremity of the catchment area in direction parallel to the slope until a defined channel is reached
- S = slope, in feet per foot, the difference in elevation between the

extreme point of the catchment area and the point in question, divided by the distance between the two points

TABLE 400-3 Values of N for Use in the Kerby Formula

N	Type of Surface
0.02	smooth impervious surfaces
0.10	smooth bare packed soil, free of stones
0.20	poor grass, cultivated row crops or moderately bare surfaces
0.40	pasture or average grass cover
0.60	deciduous timberland
0.80	conifer timberland, deciduous timberland with deep forest litter or dense grass cover

The time of concentration calculated for fully developed land use should not be less than 5 minutes to avoid the over sizing of inlets, storm sewers and open channels. Overland flow length should not exceed 400 feet for developed areas or 1,000 feet for undeveloped areas before being intercepted by a defined channel or storm sewer inlet. Beyond these distances, use gutter flow or channel flow velocities based on Manning's Equation. For preliminary work, the travel time (t_t) can be estimated with the help of Exhibit 400-3. Average velocity can be estimated with the help of Exhibit 400-4 (see back of this chapter).

400.2.2.c Storm Sewer or Street Gutter Flow

Travel time through the storm sewer or street gutter system to the main open channel is the sum of travel times in each individual component of the system between the uppermost inlet and the outlet. In most cases, average velocities can be used without a significant loss of accuracy. During major storm events, the sewer system may be fully taxed and additional channel flow may occur, generally at a significantly lower velocity than the flow in the storm sewers. By using the average conduit size and the average slope (excluding any vertical drops in the system), the average velocity can be estimated using Manning's Formula. Since the hydraulic radius of a pipe flowing half full is the same as when flowing full, the respective velocities are equal. Travel time may be based on the pipe flowing full or half full. The travel time through the storm sewers is computed by dividing the length of flow by the average velocity.

400.2.2.d Channel Flow

The travel time for flow in an open channel can be determined by using Manning's Formula to compute average velocities. Average velocities for channel flow should be computed assuming bankfull conditions.

Example 1 Time of Concentration of an Urbanized Watershed

Given: A model urbanized watershed is shown below. Three types of flow exist from the furthestmost point of the watershed to the outlet. The following data describes the watershed.

Reach	Description of Flow	Slope, S (Percent)	Length, L (Feet)
A to B	Overland (park, $N = 0.40$)	3.0	150
B to C	Shallow concentrated (paved)	0.5	400
C to D	Storm sewer ($n = 0.015$; diameter = 3 ft)	0.4	2,000
D to E	Open channel, gunite, trapezoidal ($b = 5$ ft; $d = 3$ ft; $R = 1.78$ ft; $Z = 1$; $n = 0.019$)	0.3	3,000

Find: Compute time of concentration (t_c) for a 25-year recurrence interval

Solution:

- 1) Compute the overland flow travel time.
Reach A to B (park). From Exhibit 400-3 for $S = 0.03$ ft/ft; $L = 150$ feet; and $N = 0.4$; $t_i = 12.7$ minutes.
- 2) Reach B to C (paved). From Exhibit 400-4 for a $S = 0.5$ percent, $L = 400$ feet; velocity, $V, = 1.4$ fps.

$$t_i = \frac{L}{60V} = \frac{400}{60(1.4)}$$

$$t_i = 4.8 \text{ minutes}$$

- 3) Compute the storm sewer flow travel time.
Reach C to D. Use Manning's Equation to compute full-pipe velocity. $R=D/4$ for a circular pipe.

$$V = \frac{1.49}{n} \left[\frac{D}{4} \right]^{2/3} (S)^{1/2}$$

$$V = 1.49/0.015(3/4)^{2/3} (0.004)^{1/2} = 5.2 \text{ fps}$$

$$t_t = L/60V = 2,000/60(5.2) = 6.4 \text{ minutes}$$

- 4) Compute the open-channel flow travel time.

Reach D to E. Use Manning's Equation to compute bankfull velocity.

$$V = 1.49/n (R)^{2/3} (S)^{1/2}$$

$$V = (1.49/0.019)(1.78)^{2/3} (0.003)^{1/2} = 6.3 \text{ fps}$$

$$t_t = L/60V = 3,000/60(6.3) = 7.9 \text{ minutes}$$

- 5) Summary

Reach	Description of Flow	Length (ft)	Velocity (fps)	Travel Time (min)
A to B	Overland	150	0.2	12.7
B to C	Shallow concentrated (paved)	400	1.4	4.8
C to D	Storm sewer	2,000	5.2	6.4
D to E	Open channel	<u>3,000</u>	6.3	<u>7.9</u>
Totals		5,550		31.8

$t_c = 32$ minutes, for the basin

400.2.3 Drainage Area, A

The drainage area or the area from which runoff is to be estimated is measured in acres when using the Rational Method.

400.3 SOIL CONSERVATION SERVICE METHODS

The Soil Conservation Service (now known as the Natural Resource Conservation Service) hydrologic methods have been widely used by engineers and hydrologists for analyses of small urban watersheds. These methods resulted from extensive analytical work using a wide range of statistical data concerning storm patterns, rainfall-runoff characteristics and many hydrologic observations in the United States. The Soil Conservation Service utilizes a 24 hour storm duration. It should be noted that when the

Soil Conservation Service storms are applied, the Type II distribution should be used for The City of Bryant.

The Soil Conservation Service methods can be applied to urban drainage areas of any size. A brief explanation of the runoff curve numbers and the tabular and graphical methods are introduced in this section. For detailed information, the user is referred to the following Soil Conservation Service publications:

NEH-4: “Hydrology,” Section 4, National Engineering Handbook

TR-20: Computer Program for Project Formulation, Hydrology

TR-55: Urban Hydrology for Small Watersheds

TP-149: A Method for Estimating Volume and Rate of Runoff in Small Watersheds

400.3.1 Soil Conservation Service Runoff Curve Number

The SCS uses an index called the runoff curve number (CN) to represent the combined hydrologic effect of the soil type, land use, hydrologic condition of the soil cover, and the antecedent soil moisture. The CN indicates the runoff potential of soil, which is not frozen. Higher CN's reflect a higher runoff potential.

The runoff equation used by the SCS is a relationship between accumulated rainfall and accumulated runoff and was derived from experimental plots for numerous soils and vegetative conditions. The SCS runoff equation is:

$$Q = \frac{(P - I_a)^2}{(P - I_a) + S} \quad \text{[eq. 400-1]}$$

where

Q = Runoff (in)

P = Rainfall (in)

S = Potential maximum retention after runoff begins (in) and

I_a = Initial abstraction (in)

Initial abstraction (I_a) is all losses before runoff begins. It includes water retained in surface depressions, water intercepted by vegetation, evaporation, and infiltration. I_a is highly variable but generally is correlated with soil and cover parameters. Through studies of many small agricultural watersheds, I_a was found to be approximated by the following empirical equation:

$$I_a = 0.2S \quad \text{[eq. 400-2]}$$

By removing I_a as an independent parameter, this approximation allows use of a combination of S and P to produce a unique runoff amount. Substituting equation 400-2 into equation 400-1 gives:

$$Q = \frac{(P-0.2S)^2}{(P+0.8S)} \quad [\text{eq. 400-3}]$$

S is related to the soil and cover conditions of the watershed through the CN. CN has a range of 0 to 100, and S is related to CN by:

$$S = \frac{[1000]}{[CN]} - 10 \quad [\text{eq. 400-4}]$$

Exhibits 400-5 and 400-6 solve equations 400-3 and 400-4 for a range of CNs and rainfalls (see back of this chapter for exhibits).

Factors considered in determining runoff curve numbers

The major factors that determine CN are the hydrologic soil group (HSG), cover type, treatment, hydrologic condition, and antecedent runoff condition (ARC). Another factor considered is whether impervious areas outlet directly to the drainage system (connected) or whether the flow spreads over pervious areas before entering the drainage system (unconnected).

Curve numbers represented in Exhibits 400-7 thru 400-10 represent average antecedent runoff conditions for urban, cultivated agricultural, other agricultural, and arid and semiarid rangeland uses.

Hydrologic Soil Groups

Infiltration rates of soils vary widely and are affected by subsurface permeability as well as surface intake rates. Soils are classified into four HSG's (A, B, C, and D) according to their minimum infiltration rate, which is obtained for bare soil after prolonged wetting.

The SCS soil classification system consists of four soil groups, which are characterized as follows:

Group A. (Low runoff potential.) Soils having high infiltration rates even when thoroughly wetted and consisting chiefly of deep, well-to excessively-drained sands or gravels. These soils have a high rate of water transmission, in that water readily passes through them.

Group B. Soils having moderate infiltration rates when thoroughly wetted and consisting chiefly of moderately deep to deep, moderately well-drained to well drained soils with moderately fine to moderately coarse textures. These soils have a moderate rate of water transmission.

Group C. Soils having slow infiltration rates when thoroughly wetted and consisting chiefly of soils with a layer that impedes downward movement of water, or soils with moderately fine to fine texture. The soils have a slow rate of water transmission.

Group D. (High runoff potential.) Soils having very slow infiltration rates when thoroughly wetted and consisting chiefly of clay soils with a high swelling potential, soils with a permanent high water table, soils with a claypan or clay layer at or near the surface and shallow soils over nearly impervious material. These soils have a very slow rate of water transmission.

The SCS has established a City of Bryant soil survey manual that gives detailed descriptions of the soils in The City of Bryant. This is generally the best means of identifying the soil group. Exhibits 400-11 and 400-12 (see back of this chapter) identify the soil names and hydrological classifications in Arkansas.

Most urban areas are only partially covered by impervious surfaces: the soil remains an important factor in runoff estimates. Urbanization has a greater effect on runoff in watersheds with soils having high infiltration rates (sands and gravels) than in watersheds predominantly of silts and clays, which generally have low infiltration rates.

The SCS cover classification includes three factors: 1) land use, 2) treatment, and 3) hydrologic condition. The land uses are subdivided by treatment practices. The hydrologic condition reflects the level of land management, which are given as poor, fair and good.

Cover Type

There are a number of methods for determining cover type. The most common are field reconnaissance, aerial photographs, and land use maps.

Treatment

Treatment is a cover type modifier to describe the management of cultivated agricultural lands. It includes mechanical practices, such as contouring and terracing, and management practices, such as crop rotations and reduced or no tillage.

Hydrologic Condition

Hydrologic condition indicates the effects of cover type and treatment on infiltration and runoff and is generally estimated from density of plant and residue cover on sample areas. Good hydrologic condition indicates that the soil usually has a low runoff potential for that specific hydrologic soil group, cover type, and treatment. Some factors to consider in estimating the effect of cover on infiltration and runoff are (a) canopy or density of lawns, crops, or other vegetative areas; (b) amount of year-round cover; (c) amount of grass or close-seeded legumes in rotations; (d) percent of residue cover; and (e) degree of surface roughness.

Antecedent soil moisture has a significant effect on runoff potential (CN). The SCS has developed three antecedent moisture conditions which are described below:

Condition I: soils are dry but not to wilting point

Condition II: average conditions

Condition III: heavy rainfall, or light rainfall and low temperatures have occurred within the last 5 days; saturated soils

The antecedent moisture condition (AMC) selected should produce reasonable runoff hydrographs results for a specific design problem. For computation of design flood events, an assumption of AMC-II conditions is recommended.

400.3.2 Time of Concentration and Travel Time

Travel time (T_t) is the time it takes water to travel from one location to another in a watershed. T_t is a component of time of concentration (T_c), which is the time for runoff to travel from the hydraulically most distant point of the watershed to a point of interest within the watershed. T_c is computed by summing all the travel times for consecutive components of the drainage conveyance system.

T_c influences the shape and peak of the runoff hydrograph. Urbanization usually decreases T_c thereby increasing the peak discharge. But T_c can be increased as a result of (a) ponding behind small or inadequate drainage systems, including storm drain inlets and road culverts, or (b) reduction of land slope through grading.

Factors affecting time of concentration and travel time

Surface roughness

One of the most significant effects of urban development on flow velocity is less retardance to flow. That is, undeveloped areas with very slow and shallow overland flow through vegetation become modified by urban development: the flow is then delivered to streets, gutters, and storm sewers that transport runoff downstream more rapidly. Travel time through the watershed is generally decreased.

Channel shape and flow patterns

In small non-urban watersheds, much of the travel time results from overland flow in upstream areas. Typically, urbanization reduces overland flow lengths by conveying storm runoff into a channel as soon as possible. Since channel designs have efficient hydraulic characteristics, runoff flow velocity increases and travel time decreases.

Slope

Slopes may be increased or decreased by urbanization, depending on the extent of site grading or the extent to which storm sewers and street ditches are used in the design of the water management system. Slope will tend to increase when channels are straightened and decrease when overland flow is directed through storm sewers, street gutters, and diversions.

Computation of travel time and time of concentration

Water moves through a watershed as sheet flow, shallow concentrated flow, open channel flow, or some combination of these. The type that occurs is a function of the conveyance system and is best determined by field inspection.

Travel time (T_t) is the ratio of flow length to flow velocity:

$$T_t = \frac{L}{3600V} \quad [\text{eq. 400-5}]$$

where:

T_t = Travel time (hr)

L = Flow length (ft)

V = Average velocity (ft/s)

3600 = conversion factor from sections to hours

Time of concentration (T_c) is the sum of T_t values for the various consecutive flow segments:

$$T_c = T_{t1} + T_{t2} + \dots T_{tm} \quad [\text{eq. 400-6}]$$

where:

T_c = Time of concentration (hr)

M = Number of flow segments

Sheet Flow

Sheet flow is flow over plane surfaces. It usually occurs in the headwater of streams. With sheet flow, the friction value (Manning's n) is an effective roughness coefficient that includes the effect of raindrop impact; drag over the plane surface; obstacles such as litter, crop ridges, and rocks; and erosion and transportation of sediment. These n values are for very shallow flow depths of about 0.1 foot or so. Table 400-4 gives Manning's n values for sheet flow for various surface conditions.

Surface description	n ¹
Smooth surfaces (concrete, asphalt, gravel, or bare soil).....	0.011
Fallow (no residue).....	0.05
Cultivated soils:	
Residue cover ≤ 20%.....	0.06
Residue cover ≥ 20%.....	0.17
Grass:	
Short grass prairie.....	0.15
Dense grasses ²	0.24
Bermudagrass.....	0.41
Range (natural).....	0.13
Woods: ³	
Light underbrush.....	0.40
Dense underbrush.....	0.80

¹ The n values are a composite of information compiled by Engman (1986).

² Includes species such as weeping lovegrass, bluegrass, buffalo grass, blue grama grass, and native grass mixtures.

³ When selecting n, consider cover to a height of about 0.1 ft. This is the only part of the plant cover that will obstruct sheet flow.

For sheet flow of less than 300 feet, use Manning's kinematic solution (Overtop and Meadows 1976) to compute T_t:

$$T_t = \frac{0.007(nL)^{0.8}}{(P_2)^{0.5}s^{0.4}} \quad [\text{eq. 400-7}]$$

where:

T_t = Travel time (hr)

n = Manning's roughness coefficient (table 400-4)

L = Flow length (ft)

P₂ = 2-year, 24-hour rainfall (in)

s = slope of hydraulic grade line (land slope, ft/ft)

This simplified form of the Manning's kinematic solution is based on the following: (1) shallow steady uniform flow, (2) constant intensity of rainfall excess (that part of a rain available for runoff), (3) rainfall duration of 24 hours, and (4) minor effect of infiltration on travel time.

Shallow concentrated flow

After a maximum of 300 feet, sheet flow usually becomes shallow concentrated flow. The average velocity for this flow can be determined from Exhibit 400-6 (see back of this chapter), in which average velocity is a function of watercourse slope and type of channel. For slopes less than 0.005 ft/ft, use equations 400-7a and 400-7b. Tillage can affect the direction of shallow concentrated flow. Flow may not always be directly down

the watershed slope if tillage runs across the slope. Table 400-5 gives Manning's n values for open channel flow for various material/surface conditions.

Table 400-5 Mannings Roughness Coefficients for Open Channel Surfaces

<u>Material</u>	<u>Typical Manning Roughness Coefficient</u>
Concrete	0.012
<u>Gravel Bottom with Sides</u>	
Concrete	0.02
Mortored stone	0.023
Riprap	0.033
<u>Natural Stream Channels</u>	
Clean, straight stream	0.03
Clean, winding stream	0.04
Winding with weeds and pools	0.05
With heavy brush and timber	0.1
<u>Flood Plains</u>	
Pasture	0.035
Field crops	0.04
Light brush and weeds	0.05
Dense brush	0.07
Dense trees	0.1

Source: Chow, 1959

After determining average velocity in Exhibit 400-4, use equation 400-5 to estimate travel time for the shallow concentrated flow segment.

$$\text{Unpaved} \quad V=16.1345 (s)^{0.5} \quad (\text{Eq. 400-7a})$$

$$\text{Paved} \quad V+20.3282 (s)^{0.5} \quad (\text{Eq. 400-7b})$$

Where

V =average velocity (ft/s)

S =slope of hydraulic grade line (watercourse slope, ft/ft)

Open Channels

Open channels are assumed to begin where surveyed cross section information has been obtained, where channels are visible on aerial photographs, or where blue lines (indicating streams) appear on United States Geological Survey (USGS) quadrangle sheets. Manning's equation or water surface profile information can be used to estimate

average flow velocity. Average flow velocity is usually determined for bankfull elevation.

Manning's equation is:

$$V = \frac{1.49}{n} r^{2/3} s^{1/2} \quad (\text{Eq. 400-7c})$$

where:

V = average velocity (ft/s)

r = hydraulic radius (ft) and is equal to a/p_w

a = cross sectional flow area (ft²)

p_w = wetted perimeter (ft)

s = slope of the hydraulic grade line (channel slope, ft/ft)

n = Manning's roughness coefficient for open channel flow (Table 400-5)

Additional manning's values for open channel flow can be obtained from standard textbooks such as Chow (1959) or Linsley et al. (1982).

After average velocity is computed using equation 400-7c, T_t for the channel segment can be estimated using equation 400-5.

Reservoirs or lakes

Sometimes it is necessary to estimate the velocity of flow through a reservoir or lake at the outlet of a watershed. This travel time is normally very small and can be assumed as zero.

Limitations

- Manning's kinematic solution should not be used for sheet flow longer than 300 feet. Equation 400-7 was developed for use with the four standard rainfall intensity-duration relationships.
- In watersheds with storm sewers, carefully identify the appropriate hydraulic flow path to estimate T_c . Storm sewers generally handle only a small portion of a large event. The rest of the peak flow travels by streets, lawns, and so on, to the outlet. Consult a standard hydraulics textbook to determine average velocity in pipes for either pressure or nonpressure flow.
- The minimum T_c used in TR-55 is 0.1 hour.
- A culvert or bridge can act as a reservoir outlet if there is significant storage behind it. The procedures in TR-55 can be used to determine the peak flow upstream of the culvert. Detailed storage routing procedures should be used to determine the outflow through the culvert.

400.3.3 Peak Flow Calculation

The Soil Conservation Service has developed several methods for computing runoff hydrographs for drainage areas. The following considers the Tabular and Graphical methods.

Tabular Method

The Tabular Method can be used to develop composite flood hydrographs at any point within a watershed by dividing the watershed into sub-areas. The method is useful for watersheds where runoff hydrographs are needed from non-homogeneous areas, i.e., the watershed can be divided into homogeneous sub-areas. It is especially applicable for estimating the effects of land use change in a portion of the watershed. It should be noted that the tables in the TR-55 publication for the tabular method are based on the Soil Conservation Service 24 hour rainfall distributions. The engineer should apply those tables corresponding to a Type II rainfall distribution, which is acceptable for The City of Bryant.

The basic requirement for use of this method is the tabular discharge values for different types of storm distributions. The tabular discharge values in cubic feet of discharge per square mile of watershed per inch of runoff (csm/in) are given in TR-55 for a range of time of concentrations from 0.1 hours to two (2) hours and reach travel times of 0 to three (3) hours. The discharge values were developed from the TR-20 program by computing hydrographs for a one square mile drainage area at selected times of concentration and routing them through stream reaches with the range of travel times indicated.

The other input needed to develop the composite flood hydrograph includes the total runoff (Q) and the drainage area (A_m). The equation for calculating the flow at any time is:

$$q = q_t A_m Q \quad (400-8)$$

where,

q = hydrograph ordinate at hydrograph time t (cfs)

q_t = individual value read from the tabular discharge tables (csm/inch)

A_m = drainage area of individual subwatershed (sq.mi.)

Q = total runoff (inches)

The composite flood hydrograph is obtained by summation of the individual sub-area hydrographs at each time step. For measuring runoff from a non-homogeneous watershed, the subdivision of the watershed into relatively homogeneous sub-areas is required. For additional information regarding the Tabular Method, the SCS publication TR-55 should be consulted.

Graphical Method

As in the Tabular Method, the Graphical Method is based on hydrograph analyses using the TR-20 computer program. The Graphical Method provides a determination of peak discharge only. If a hydrograph is needed or watershed subdivision is required, use the Tabular method or another hydrograph producing method such as HEC-1 or TR-20. TR-55 lists in detail the limitations of the Graphical Method and the engineer should be well aware of these before proceeding. The input requirements for the Graphical Method are as follows:

1. t_c (hours)
2. drainage area (sq.mi.)
3. Type II rainfall distribution
4. 24-hr rainfall (inches)
5. Curve Number

The peak discharge equation for the graphical method is:

$$q_p = q_u A_m Q F_p \quad (400-9)$$

where:

q_p	=	peak discharge (cfs)
q_u	=	unit peak discharge (csm/in)
A_m	=	drainage area (sq.mi.)
Q	=	runoff (in.)
F_p	=	pond and swamp adjustment factor

400.4 HYDROLOGIC MODELS

Hydrologic models provide for a more complex approach to computing runoff for areas larger than 200 acres. These models are especially useful if storage is to be evaluated or if complex hydrologic conditions exist within the drainage basin to be studied. In general, hydrologic models allow for the temporal variation of rainfall intensity to be simulated and describe the shape of a hydrograph in a realistic manner (i.e., the initial onset of the storm produces little runoff and as a larger portion of the basin contributes the runoff increases, and finally a peak occurs. The storm reduces in intensity and the runoff diminishes until it has reached its baseflow or a no flow condition).

Basically, in hydrologic models, the transformation from rainfall excess to streamflow is accomplished through unit hydrograph routing procedures. These procedures allow hydrograph analysis concepts to be applied to watersheds through the development and application of generalized functions for estimating the amount of precipitation lost due to interception and infiltration (loss rates), unit hydrographs, and base flow. The unit hydrograph is usually assumed to give a unique relationship between rainfall excess and surface runoff for a basin regardless of storm size, losses, or other factors. Because of its ease of use, the unit hydrograph has received the most attention by hydrologists.

400.5 COMPUTERIZED HYDROLOGIC ANALYSIS PACKAGES

There are various hydrologic analysis packages available to calculate the runoff from a watershed. HEC-1 is recommended, but if another hydrograph procedure is used approval of the method shall be obtained from the City of Bryant Director of Public Works prior to the design or analysis. Several hydrologic programs are summarized below.

A. The Flood Hydrograph Package, HEC-1, was developed by the U.S. Army Corps of Engineers Hydrologic Engineering Center (HEC). HEC-1 is a compilation of several methods including various unit hydrograph procedures, loss rate functions, and channel and reservoir routing options. If a hydrograph procedure is required, other models may be used, but a HEC-1 analysis is generally recommended.

B. The Technical Release No. 20, "Computer Program for Project Formulation - Hydrology", TR-20 was originally developed by the USDA, Soil Conservation Service (SCS) and has been modified by the SCS and other groups. TR-20 uses the procedures described in the SCS National Engineering Handbook, Section 4, Hydrology (NEH-4),

C. Under the sponsorship of the U.S. Environmental Protection Agency (EPA), a comprehensive mathematical model capable of representing urban storm water runoff and combined sewer overflow phenomena was developed. It is referred to as the Storm Water Management Model (SWMM). SWMM simulates the runoff of a drainage basin for any prescribed rainfall pattern. A total watershed is segmented into a number of smaller basins or sub-catchments that can be readily described by its hydraulic or geometric properties. Manning's equation is used to route the excess uniform rainfall across overland surfaces, and through gutters, pipes and streams. The SWMM model simulates both water quantity and quality aspects, which are associated with urban runoff and combined sewer systems.

400.6 HEC-1 MODEL

The Flood Hydrograph Package, HEC-1, model was developed and is supported by the U.S. Army Corps of Engineers Hydrologic Engineering Center (HEC), Davis, California. The model is designed to simulate the surface runoff response of a drainage basin to a precipitation input. For purposes of this Manual, all references in the HEC-1 manual to a "river basin" have been changed to "drainage basin." The model represents the basin as an interconnected system of hydrologic and hydraulic components. Each component models an aspect of the precipitation-runoff process within a portion of the basin commonly referred to as a sub-basin. A component may be a surface runoff entity, a stream channel, or a reservoir. Representation of a component requires a set of parameters, which specify the particular characteristics of the component, and mathematical relationships, which describe the physical processes. The result of the modeling is the computation of streamflow hydrographs at desired locations in the watershed basin. The major components of the model are discussed briefly. It is

recommended that the user solicit additional information in the Users Manual for HEC-1, Flood Hydrograph Package.

400.7 HEC-HMS

The Hydrologic Modeling System is designed to simulate the precipitation-runoff processes of dendritic watershed systems. It is designed to be applicable in a wide range of geographic areas for solving the widest possible range of problems. This includes large river basin water supply and flood hydrology, and small urban or natural watershed runoff. Hydrographs produced by the program are used directly or in conjunction with other software for studies of water availability, urban drainage, flow forecasting, future urbanization impact, reservoir spillway design, flood damage reduction, floodplain regulation, and systems operation.

The program features a completely integrated work environment including a database, data entry utilities, computation engine, and results reporting tools. A graphical user interface allows the user seamless movement between the different parts of the program. Program functionality and appearance are the same across all supported platforms.

400.8 Hydrologic Engineering Center (HEC)

The primary goal of HEC is to support the nation in its water resources management responsibilities by increasing the Corps technical capability in hydrologic engineering and water resources planning and management. An additional goal is to provide leadership in improving the state-of-the-art in hydrologic engineering and analytical methods for water resources planning.

By means of programs in research, training, planning analysis, and technical assistance, efforts are made to be aware of the problems and needs of the Corps and the nation. A commitment is also made to keep abreast of the latest developments throughout the profession, and to make use of this information in a manner best suited to the needs of the Corps.

HEC increases the effectiveness of the Corps and the profession by bridging the gap between the academic community, practicing hydrologic engineers, and planning professionals. Research or training activities that can be best accomplished by universities is not undertaken. HEC incorporates state-of-the-art procedures and techniques into manuals and comprehensive computer programs. The procedures are made available to the Corps, United States and international professionals through an effective technology transfer system of technical assistance, publications, video tapes, and training.

The U.S. Army Corps of Engineers (USACE) Hydrologic Engineering Center (HEC) was formed in 1964 to institutionalize the technical expertise that subsequently became known as hydrologic engineering. The cadre of engineers that had come to the USACE following World War II were approaching retirement age, and there was concern that their expertise that had evolved from the on-going unprecedented Corps water resources

development activities would dissipate and be difficult to restore. HEC was established in the USACE Sacramento District within the Engineering Division. Principals involved included: Albert Cochran, HQUSACE Hydrology and Hydraulics Chief, who formed and sold the idea of an HEC; Emilio Gomez, Sacramento District Chief of Engineering Division; and Roy Beard, then the District Reservoir Control Chief and subsequently HEC founding Director. HEC immediately set to work organizing and presenting training courses, the first of such kind in the Corps, and initiating development of what later became to be the well-known family of HEC software. Early software packages were HEC-1 (watershed hydrology), HEC-2 (river hydraulics), HEC-3 (reservoir analysis for conservation), and HEC-4 (stochastic streamflow generation program). Within ten years after establishment, the technical field of planning analysis, the application of analytical methods to planning activities closely associated with hydrologic engineering, was added to the HEC mission. By that time, the permanent staff had risen to about 30 engineers and computer specialists. HEC staff is about that same size today.

In its history, HEC went through a series of organizational reporting realignments, but has for the most part, maintained generally the same scope of activities, staff, support to the field ethic, and output products. HEC moved from under the Sacramento District Engineering Chief to reporting to the District Commander, and by the early 1970s, had successively been realigned to report to the South Pacific Division Commander, then to HQUSACE Director of Civil Works, and then finally became an organization within the Water Resources Support Center (WRSC). HEC remained assigned to WRSC for about twenty years until WRSC was dissolved in 2000 to be replaced by the Institute for Water Resources (IWR), then a sister organization to HEC within WRSC. Today, HEC is one of six organizations within IWR - two Centers and four divisions. IWR reports to the Deputy Director of Civil works and is classified as a Civil Works Support Office.

Over the years, HEC developed and published a number of technical methods documents addressing the full range of hydrologic engineering and planning analysis technologies. The format and content for technical short courses evolved early on and continues to be a mainstay of the HEC program. The family of software has grown to over twenty major programs that are supported by a library of utility programs, recent additions including GIS support. HEC is perhaps best known for these nationally and internationally renowned hydrologic engineering programs.

HEC is organized into an Executive Office and three divisions: Hydrology and Hydraulics Technology; Water Resource Systems; and Water Management Systems. Staffs in all divisions undertake training, methods documentation, research and development, technical assistance and special projects. Notable recent achievements include: development of the NexGen family of successor HEC software (HEC-RAS, HEC-HMS, HEC-FDA, and HEC-ResSim); providing leadership in establishing risk analysis as the foundation technology for flood damage reduction planning and analysis; and development and deployment of the Corps Water Management System (CWMS), the real-time forecasting and decision-support system that is used 24/7 in execution of the USACE Civil Works water resource water control management mission.

For additional information on other Corps topics or programs at the HEC Level, please feel free to contact one of the following Point of Contact numbers at the HEC Office in California:

Mailing Address: Department of the Army Corps of Engineers
Institute for Water Resources
Hydrologic Engineering Center
609 Second Street
Davis, CA 95616-4687

HEC Phone: (530) 756-1104

HEC Fax: (530) 756-8250

Webmaster E-Mail: hec.webmaster@usace.army.mil

For additional information on other Corps topics or programs at the National Level, please feel free to contact one of the following Point of Contact numbers at the Corps' Headquarters Office in Washington DC:

Topic	Phone Number
Construction Projects (Civil Works)	202-761-5856
Construction Projects (Military Program)	202-761-0381
Contracting with Us	202-761-0566
Emergency Response Mission	202-761-1001
Employment Opportunities	202-761-0559
Environmental	202-528-4285
History	703-428-6554
Locks & Dams	202-761-4692
Navigation	202-761-4692
Recreation	202-761-4751
Regulatory	202-761-4616
Wetlands Permits	202-761-4616
General Questions	202-761-0011

Intensity – Duration - Frequency

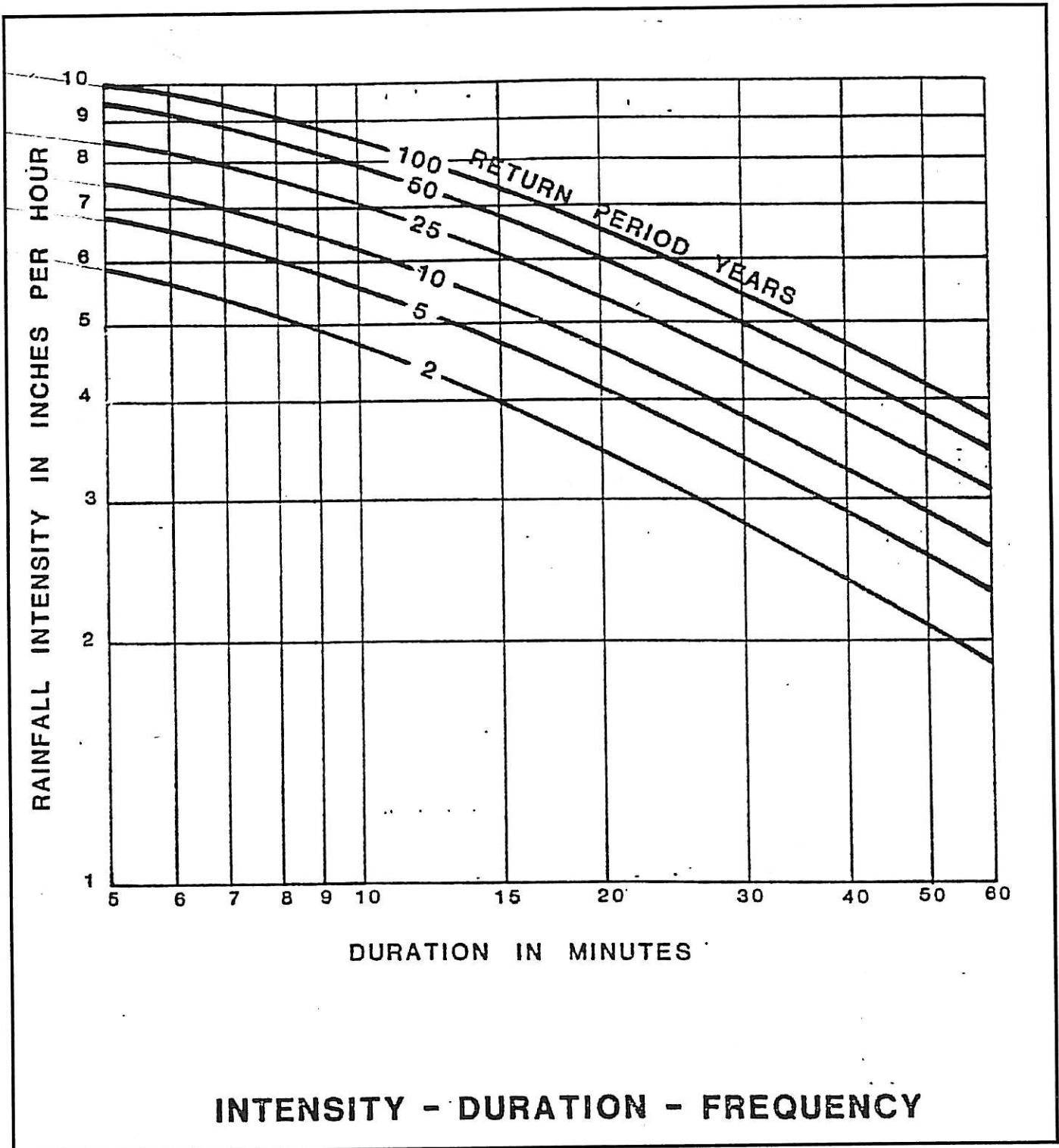

Exhibit 400-1 (Source: City of Little Rock Drainage Manual)

Intensity – Duration - Frequency

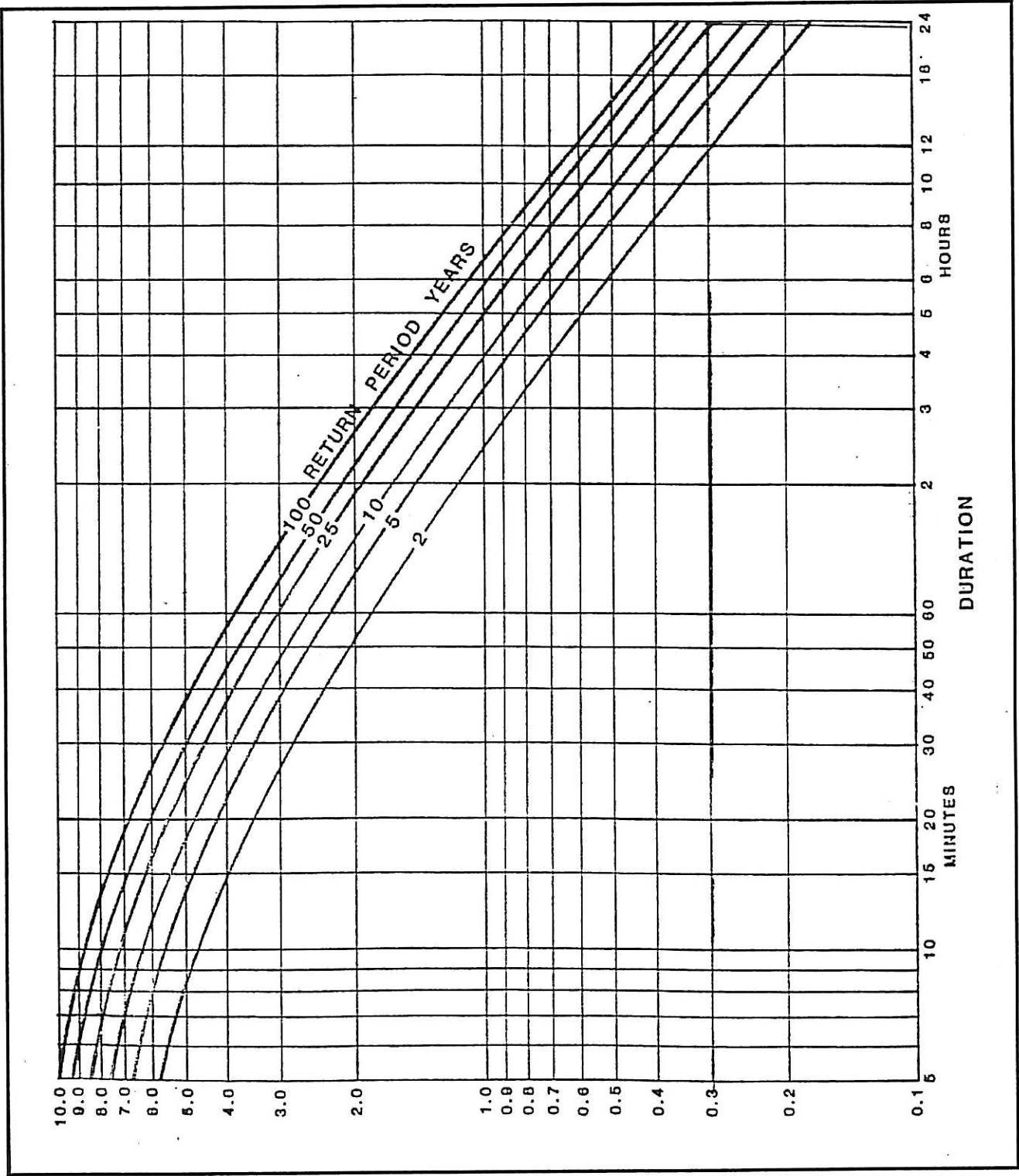

Exhibit 400-2 (Source: City of Little Rock Drainage Manual)

Nomograph for Time of Concentration

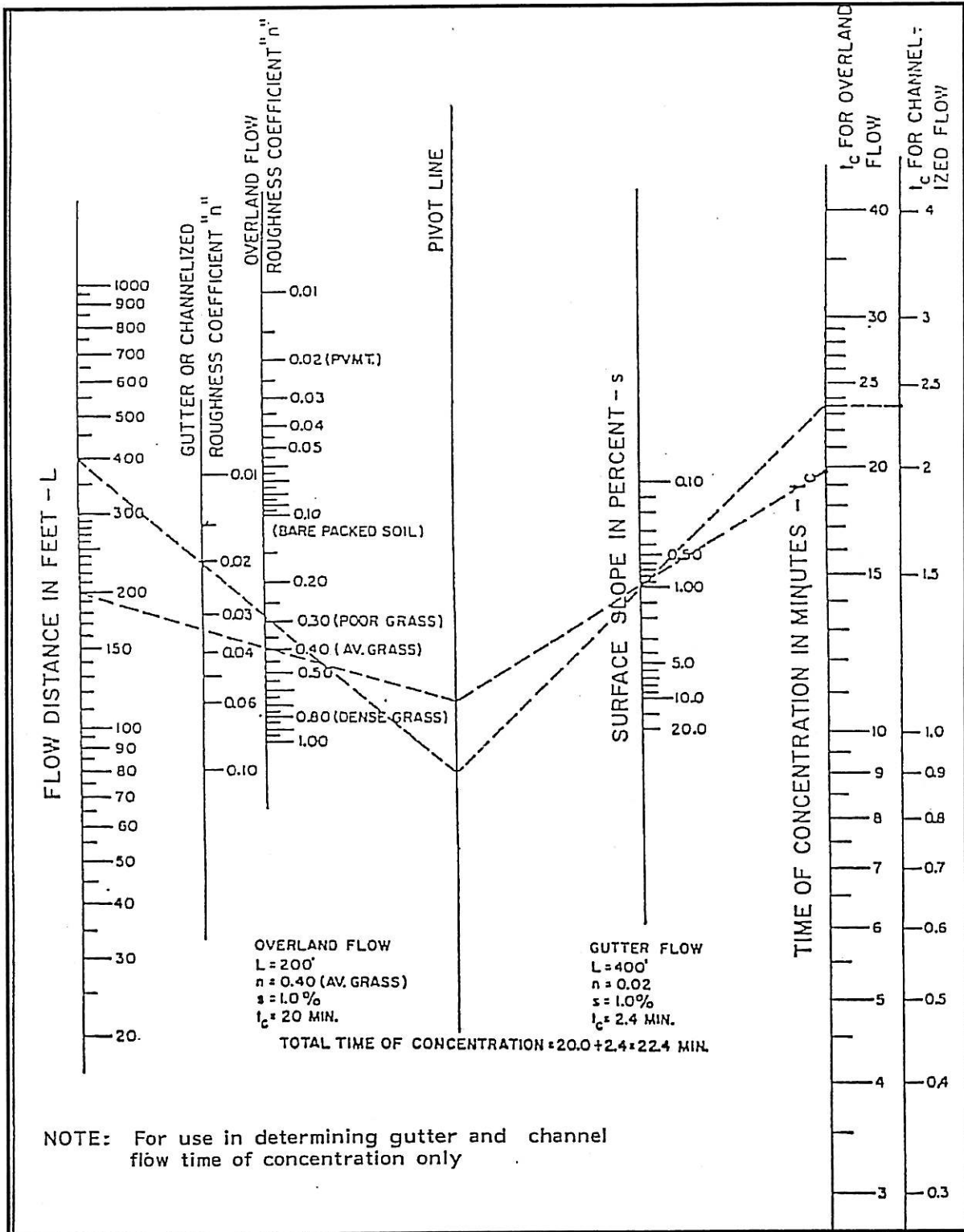

Exhibit 400-3 (Source: City of Little Rock Drainage Manual)

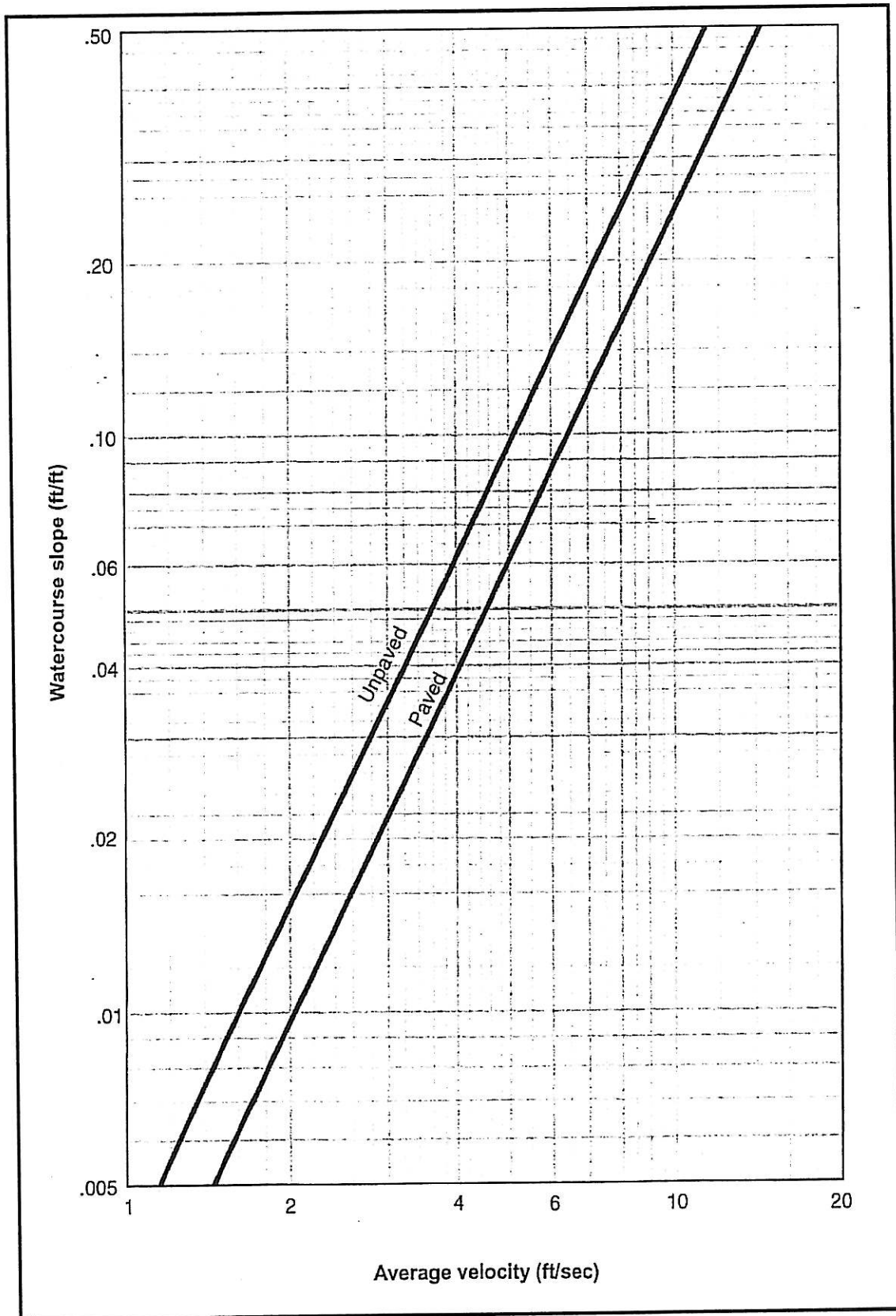

Exhibit 400-4 (Source: NRCS (SCS) TR55)

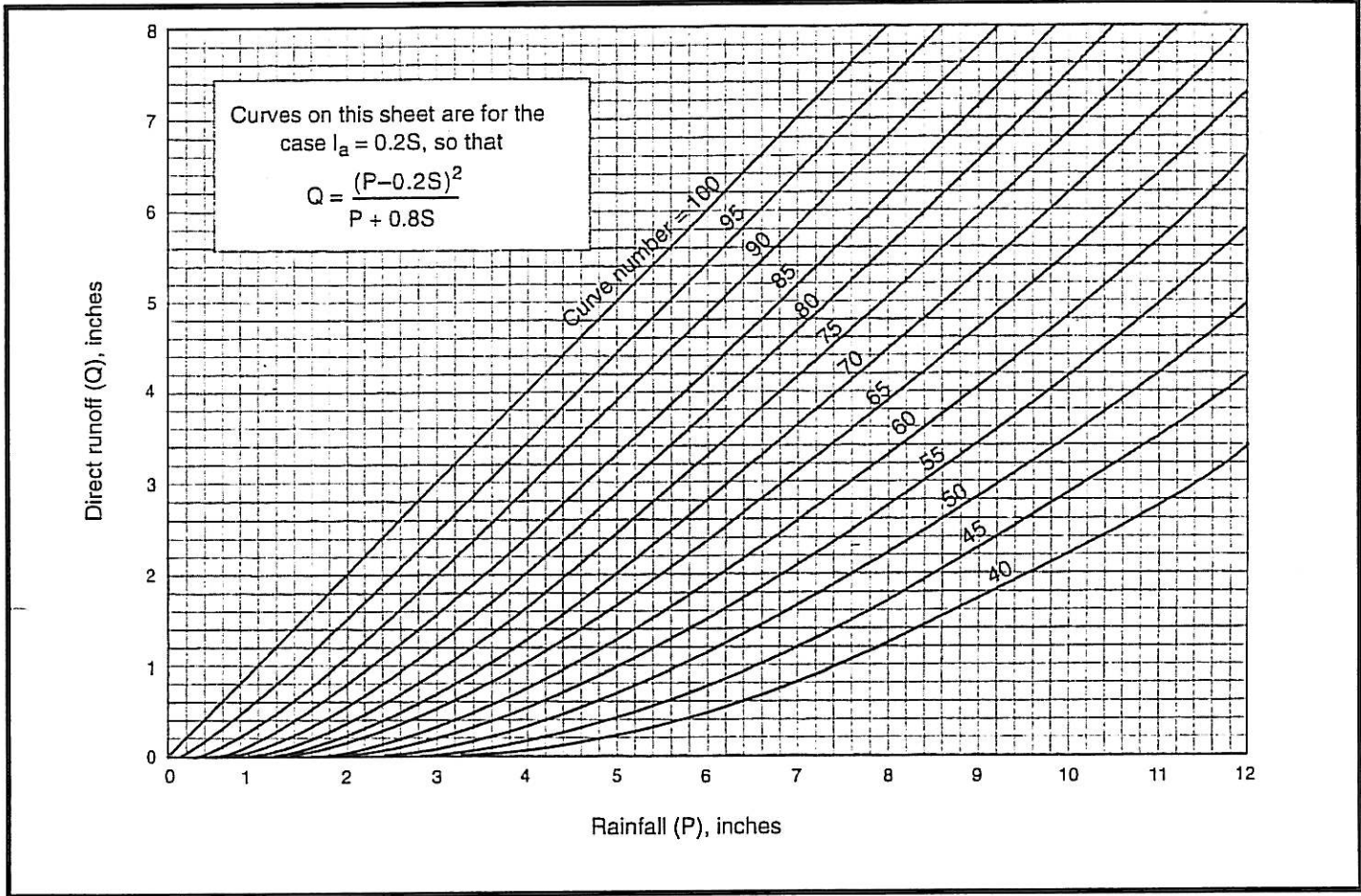

Exhibit 400-5
Solution of Runoff Equation
(Source: NRCS (SCS) TR55)

Rainfall	Runoff depth for curve number of—												
	40	45	50	55	60	65	70	75	80	85	90	95	98
	—inches—												
1.0	0.00	0.00	0.00	0.00	0.00	0.00	0.00	0.03	0.08	0.17	0.32	0.56	0.79
1.2	.00	.00	.00	.00	.00	.00	.03	.07	.15	.27	.46	.74	.99
1.4	.00	.00	.00	.00	.00	.02	.06	.13	.24	.39	.61	.92	1.18
1.6	.00	.00	.00	.00	.01	.05	.11	.20	.34	.52	.76	1.11	1.38
1.8	.00	.00	.00	.00	.03	.09	.17	.29	.44	.65	.93	1.29	1.58
2.0	.00	.00	.00	.02	.06	.14	.24	.38	.56	.80	1.09	1.48	1.77
2.5	.00	.00	.02	.08	.17	.30	.46	.65	.89	1.18	1.53	1.96	2.27
3.0	.00	.02	.09	.19	.33	.51	.71	.96	1.25	1.59	1.98	2.45	2.77
3.5	.02	.08	.20	.35	.53	.75	1.01	1.30	1.64	2.02	2.45	2.94	3.27
4.0	.06	.18	.33	.53	.76	1.03	1.33	1.67	2.04	2.46	2.92	3.43	3.77
4.5	.14	.30	.50	.74	1.02	1.33	1.67	2.05	2.46	2.91	3.40	3.92	4.26
5.0	.24	.44	.69	.98	1.30	1.65	2.04	2.45	2.89	3.37	3.88	4.42	4.76
6.0	.50	.80	1.14	1.52	1.92	2.35	2.81	3.28	3.78	4.30	4.85	5.41	5.76
7.0	.84	1.24	1.68	2.12	2.60	3.10	3.62	4.15	4.69	5.25	5.82	6.41	6.76
8.0	1.25	1.74	2.25	2.78	3.33	3.89	4.46	5.04	5.63	6.21	6.81	7.40	7.76
9.0	1.71	2.29	2.88	3.49	4.10	4.72	5.33	5.95	6.57	7.18	7.79	8.40	8.76
10.0	2.23	2.89	3.56	4.23	4.90	5.56	6.22	6.88	7.52	8.16	8.78	9.40	9.76
11.0	2.78	3.52	4.26	5.00	5.72	6.43	7.13	7.81	8.48	9.13	9.77	10.39	10.76
12.0	3.38	4.19	5.00	5.79	6.56	7.32	8.05	8.76	9.45	10.11	10.76	11.39	11.76
13.0	4.00	4.89	5.76	6.61	7.42	8.21	8.98	9.71	10.42	11.10	11.76	12.39	12.76
14.0	4.65	5.62	6.55	7.44	8.30	9.12	9.91	10.67	11.39	12.08	12.75	13.39	13.76
15.0	5.33	6.36	7.35	8.29	9.19	10.04	10.85	11.63	12.37	13.07	13.74	14.39	14.76

Exhibit 400-6
Runoff Depths for Selected CNs and Rainfall Amounts
 (Source: NRCS (SCS) TR55)

Cover description Cover type and hydrologic condition	Average percent impervious area ^{2/}	Curve numbers for hydrologic soil group			
		A	B	C	D
<i>Fully developed urban areas (vegetation established)</i>					
Open space (lawns, parks, golf courses, cemeteries, etc.) ^{3/} :					
Poor condition (grass cover < 50%)		68	79	86	89
Fair condition (grass cover 50% to 75%)		49	69	79	84
Good condition (grass cover > 75%)		39	61	74	80
Impervious areas:					
Paved parking lots, roofs, driveways, etc. (excluding right-of-way)		98	98	98	98
Streets and roads:					
Paved; curbs and storm sewers (excluding right-of-way)		98	98	98	98
Paved; open ditches (including right-of-way)		83	89	92	93
Gravel (including right-of-way)		76	85	89	91
Dirt (including right-of-way)		72	82	87	89
Western desert urban areas:					
Natural desert landscaping (pervious areas only) ^{4/}		63	77	85	88
Artificial desert landscaping (impervious weed barrier, desert shrub with 1- to 2-inch sand or gravel mulch and basin borders)		96	96	96	96
Urban districts:					
Commercial and business	85	89	92	94	95
Industrial	72	81	88	91	93
Residential districts by average lot size:					
1/8 acre or less (town houses)	65	77	85	90	92
1/4 acre	38	61	75	83	87
1/3 acre	30	57	72	81	86
1/2 acre	25	54	70	80	85
1 acre	20	51	68	79	84
2 acres	12	46	65	77	82
<i>Developing urban areas</i>					
Newly graded areas (pervious areas only, no vegetation) ^{5/}					
		77	86	91	94
Idle lands (CN's are determined using cover types similar to those in table 2-2c).					

¹ Average runoff condition, and $I_a = 0.2S$.

² The average percent impervious area shown was used to develop the composite CN's. Other assumptions are as follows: impervious areas are directly connected to the drainage system, impervious areas have a CN of 98, and pervious areas are considered equivalent to open space in good hydrologic condition. CN's for other combinations of conditions may be computed using figure 2-3 or 2-4.

³ CN's shown are equivalent to those of pasture. Composite CN's may be computed for other combinations of open space cover type.

⁴ Composite CN's for natural desert landscaping should be computed using figures 2-3 or 2-4 based on the impervious area percentage (CN = 98) and the pervious area CN. The pervious area CN's are assumed equivalent to desert shrub in poor hydrologic condition.

⁵ Composite CN's to use for the design of temporary measures during grading and construction should be computed using figure 2-3 or 2-4 based on the degree of development (impervious area percentage) and the CN's for the newly graded pervious areas.

Exhibit 400-7
Runoff Curve Numbers for Urban Areas
(Source: NRCS (SCS) TR55)

Cover description			Curve numbers for hydrologic soil group			
Cover type	Treatment ²	Hydrologic condition ³	A	B	C	D
Fallow	Bare soil	—	77	86	91	94
	Crop residue cover (CR)	Poor	76	85	90	93
		Good	74	83	88	90
Row crops	Straight row (SR)	Poor	72	81	88	91
		Good	67	78	85	89
	SR + CR	Poor	71	80	87	90
		Good	64	75	82	85
	Contoured (C)	Poor	70	79	84	88
		Good	65	75	82	86
	C + CR	Poor	69	78	83	87
		Good	64	74	81	85
	Contoured & terraced (C&T)	Poor	66	74	80	82
		Good	62	71	78	81
	C&T+ CR	Poor	65	73	79	81
Good		61	70	77	80	
Small grain	SR	Poor	65	76	84	88
		Good	63	75	83	87
	SR + CR	Poor	64	75	83	86
		Good	60	72	80	84
	C	Poor	63	74	82	85
		Good	61	73	81	84
	C + CR	Poor	62	73	81	84
		Good	60	72	80	83
	C&T	Poor	61	72	79	82
		Good	59	70	78	81
	C&T+ CR	Poor	60	71	78	81
Good		58	69	77	80	
Close-seeded or broadcast legumes or rotation meadow	SR	Poor	66	77	85	89
		Good	58	72	81	85
	C	Poor	64	75	83	85
		Good	55	69	78	83
	C&T	Poor	63	73	80	83
		Good	51	67	76	80

¹ Average runoff condition, and $I_a=0.2S$

² Crop residue cover applies only if residue is on at least 5% of the surface throughout the year.

³ Hydraulic condition is based on combination factors that affect infiltration and runoff, including (a) density and canopy of vegetative areas, (b) amount of year-round cover, (c) amount of grass or close-seeded legumes, (d) percent of residue cover on the land surface (good $\geq 20\%$), and (e) degree of surface roughness.

Poor: Factors impair infiltration and tend to increase runoff.

Good: Factors encourage average and better than average infiltration and tend to decrease runoff.

Exhibit 400-8
Runoff Curve Numbers for Cultivated Agricultural Lands
 (Source: NRCS (SCS) TR55)

Cover description	Hydrologic condition	Curve numbers for hydrologic soil group			
		A	B	C	D
Pasture, grassland, or range—continuous forage for grazing. ²	Poor	68	79	86	89
	Fair	49	69	79	84
	Good	39	61	74	80
Meadow—continuous grass, protected from grazing and generally mowed for hay.	—	30	58	71	78
Brush—brush-weed-grass mixture with brush the major element. ³	Poor	48	67	77	83
	Fair	35	56	70	77
	Good	30 ⁴	48	65	73
Woods—grass combination (orchard or tree farm). ⁵	Poor	57	73	82	86
	Fair	43	65	76	82
	Good	32	58	72	79
Woods. ⁶	Poor	45	66	77	83
	Fair	36	60	73	79
	Good	30 ⁴	55	70	77
Farmsteads—buildings, lanes, driveways, and surrounding lots.	—	59	74	82	86

¹ Average runoff condition, and $I_a = 0.2S$.

² *Poor*: <50% ground cover or heavily grazed with no mulch.
Fair: 50 to 75% ground cover and not heavily grazed.
Good: > 75% ground cover and lightly or only occasionally grazed.

³ *Poor*: <50% ground cover.
Fair: 50 to 75% ground cover.
Good: >75% ground cover.

⁴ Actual curve number is less than 30; use CN = 30 for runoff computations.

⁵ CN's shown were computed for areas with 50% woods and 50% grass (pasture) cover. Other combinations of conditions may be computed from the CN's for woods and pasture.

⁶ *Poor*: Forest litter, small trees, and brush are destroyed by heavy grazing or regular burning.
Fair: Woods are grazed but not burned, and some forest litter covers the soil.
Good: Woods are protected from grazing, and litter and brush adequately cover the soil.

Exhibit 400-9
Runoff Curve Numbers for Cultivated Agricultural Lands
 (Source: NRCS (SCS) TR55)

Cover description		Curve numbers for hydrologic soil group			
Cover type	Hydrologic condition ^{2/}	A ^{3/}	B	C	D
Herbaceous—mixture of grass, weeds, and low-growing brush, with brush the minor element.	Poor		80	87	93
	Fair		71	81	89
	Good		62	74	85
Oak-aspen—mountain brush mixture of oak brush, aspen, mountain mahogany, bitter brush, maple, and other brush.	Poor		66	74	79
	Fair		48	57	63
	Good		30	41	48
Pinyon-juniper—pinyon, juniper, or both; grass understory.	Poor		75	85	89
	Fair		58	73	80
	Good		41	61	71
Sagebrush with grass understory.	Poor		67	80	85
	Fair		51	63	70
	Good		35	47	55
Desert shrub—major plants include saltbush, greasewood, creosotebush, blackbrush, bursage, palo verde, mesquite, and cactus.	Poor	63	77	85	88
	Fair	55	72	81	86
	Good	49	68	79	84

¹ Average runoff condition, and $I_a = 0.2S$. For range in humid regions, use table 2-2c.

² Poor: <30% ground cover (litter, grass, and brush overstory).
Fair: 30 to 70% ground cover.
Good: > 70% ground cover.

³ Curve numbers for group A have been developed only for desert shrub.

Exhibit 400-10
Runoff Curve Numbers for Arid and Semiarid Rangelands
 (Source: NRCS (SCS) TR55)

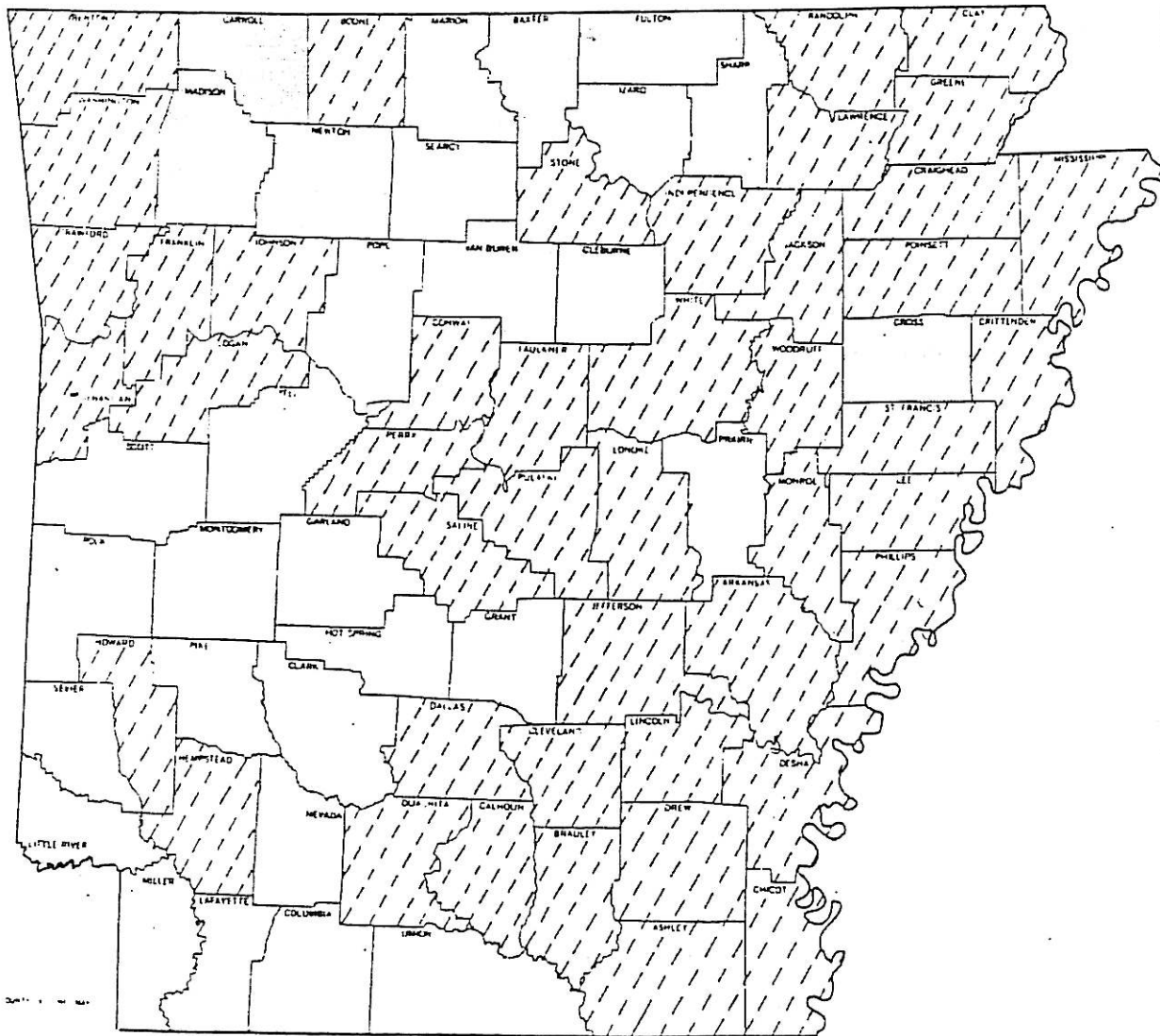

LEGEND



-  General Soil Map Available
-  Comprehensive Soil Survey Manual Available

Exhibit 400-11
Status of Soil Surveys in Arkansas
(Source: Arkansas Highway and Transportation Department Drainage Manual)

Acadia D	Dunning D	Leeper D	Ramsey D
Adston D		Leesburg B	Rarort B
Agnes B	Earle D	Lexington B	Rexor A
Alaga A	Egan C	Lindside C	Rilla B
Allen B	Eisah B	Lily B	Roanoke D
Alligator D	Emory B	Linker B	Robinsville B
Amagon D	Enders C	Lobelville C	Roeller D
Amy D	Ennis B	Locust C	Rouston D
Angie C	Estate C	Lonoke B	Ruston B
Apison B	Etowah B	Loring C	
Arkabutla C	Eutaw D	Lucy A	Sacul D
Ashton B	Eylau C	Luverne C	Saffell B
Ashwood C			Sallisaw B
Askew C	Falava C	Mantachie C	Samba D
Avilla B	Falkner C	Marietta C	Sardis C
	Fatima B	Marvell B	Savannah C
Barling C	Fayetteville B	Mashulaville D	Sawyer C
Baxter B	Felker D	Mayes D	Secesh B
Beasley C	Foley D	Maynew D	Sequatchie B
Beulah B	Forrestdale D	McCrorry D	Sessum D
Bibs D	Fountain D	McGehee C	Sharkey D
Billyhaw D		McKamic D	Sherwood B
Blevins B	Gallion B	McLaurin B	Shubuta C
Boden C	Gasconade D	Melvin D	Sidon C
Bodine B	Gassville C	Memphis B	Sloan D
Bonn D	Geep B	Mhoon D	Smithdale B
Bosket B	Gladwater D	Miller D	Smithton D
Boswell D	Goldsboro C	Hillwood D	Sogn D
Bowdre C	Goldston C	Moko C	Spadra B
Bowie B	Gore D	Monongahela C	Stanser B
Brandor B	Grenda C	Montevallo D	State B
Briley B	Grubbs D	Moreland D	Steele B
Britwater B	Guin A	Morganfield B	Steprock B
Brocket C	Guthrie D	Morse D	Sterlington B
Broseley B	Guyton D	Mountainburg D	Stough C
Bruno A		Muldrow D	Sturkie B
Bude C	Harleston C	Muskogee C	Stuttgart D
Buxir D	Hartsells B	Myatt D	Summit C
Brockwell B	Hatchie C		Sumter C
	Hayti D	Nacogdoches B	Susquehanna D
Caddo D	Healing B	Natchez E	
Cahaba B	Hebert C	Neila B	Taft C
Calhoun D	Hector D	Newark C	Talbott C
Calloway C	Henry D	Newellton D	Taloka D
Cane C	Hillemann C	Newtonia B	Terouge D
Captina C	Hollywood D	Nixa C	Tiak C
Carnasaw C	Holston B	Noark B	Tichnor D
Carytown D	Houlka D	Norfolk B	Tippah C
Cascilla B	Houston D	Norwood B	Tiptonville B
Caspiana B	Huntington B	Nugent A	Toine B
Catalpa C			Townley C
Cede B	Iberia D	Oaklimerer C	Trebloc D
Chastain D	Iuka C	Oklared B	Trinity D
Chennely C	Izadora C	Ochlockonee B	Troup A
Cherokee D		Oktibbeha B	Tuckerman D
Christian C	Jackport D	Ora C	Tunica D
Clarksville B	Jay C	Orangeburg B	Tuscumbia D
Clebit D	Jeanerette D	Ouachita C	Tutwiler B
Cleora B	Johnsburg D	Ozan D	
Collins C			Una D
Commerce C	Kalmia B	Patterson C	
Conasauga C	Kamic B	Pembroke B	Vaiden D
Convent C	Karma B	Peridge B	Ventris D
Corydon D	Kaufman D	Perry D	
Coushatta B	Kec B	Pheba D	Wabbasaka D
Crevassee A	Klematis A	Philo C	Waben B
Crowley D	Kipling D	Pickens D	Wardell C
Cuthbert C	Kirvin C	Pickwick E	Waverly D
	Kobel D	Pikeville B	Waynesboro B
Darco A		Pirum B	Weston D
Dardanelle B	Lafe D	Pipe B	Wickham B
Demopolis C	Lagrange D	Protia C	Widemar A
Desho D	Latanier D	Portland D	Wilcox D
Dexter B	Latoria B	Prentiss C	Wilson S
Doniphan B	Leadvale C	Providence C	
Dubbs B	Leaf C		
Dundee C			

Exhibit 400-12

Soil Names and Hydrological Classification in Arkansas

(Source: Arkansas Highway and Transportation Department Drainage Manual)

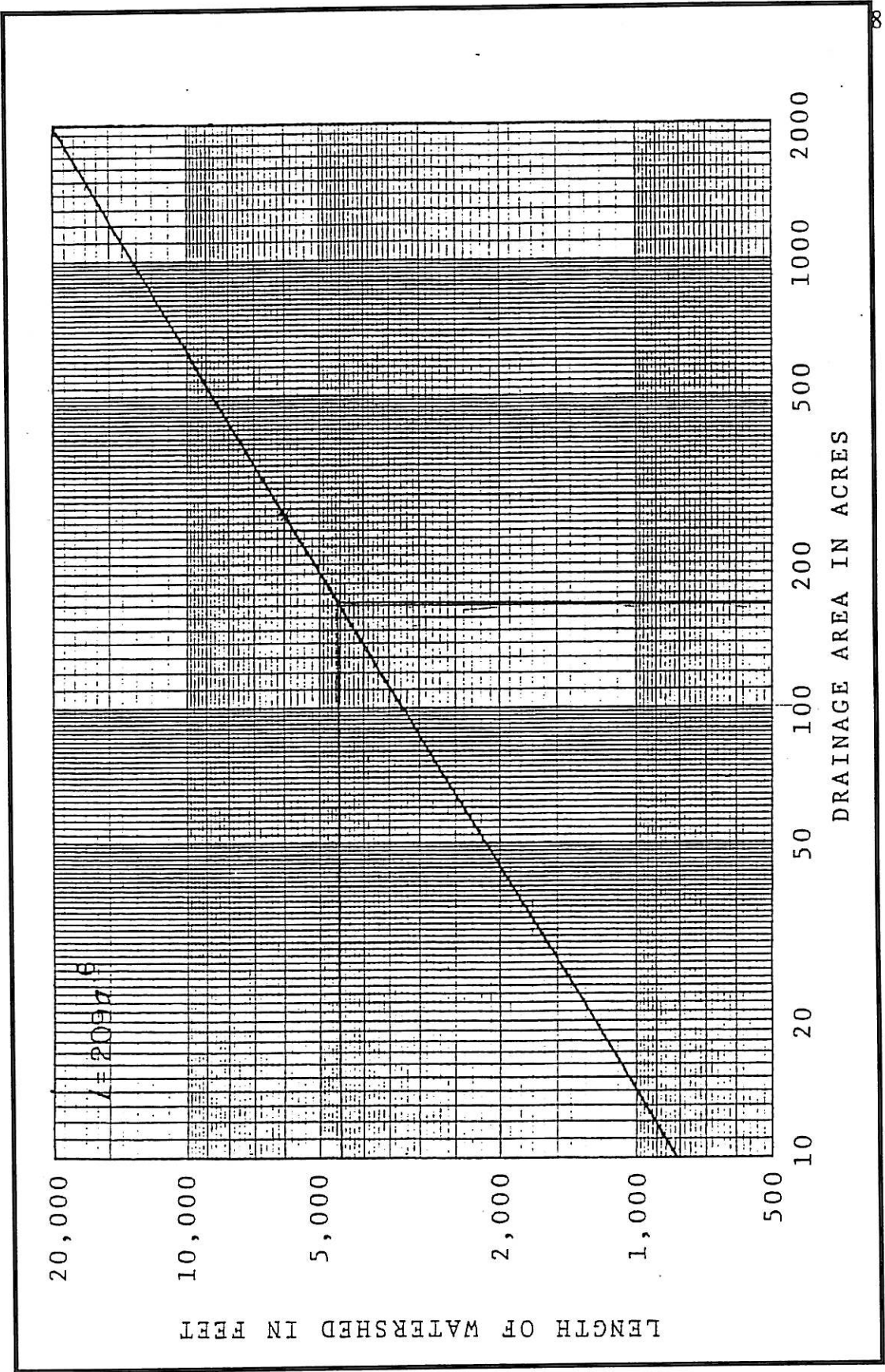

Exhibit 400-13

(Source: Arkansas Highway and Transportation Department Drainage Manual)

**SECTION 500
OPEN CHANNEL FLOW**

	<u>Page</u>
500.1 INTRODUCTION	91
500.2 FLOW OF OPEN CHANNEL	92
500.3 DESIGN CRITERIA	92
500.4 TYPES OF CHANNELS	92-94
500.5 CHANNEL DISCHARGE	94-102
500.6 DESIGN CONSIDERATIONS	102-108
500.7 DESIGN STANDARDS	108-117
500.8 WATER SURFACE PROFILE ANALYSIS	117
500.9 FLOOD PROOFING	118
500.10 ENERGY DISSIPATERS	118-119
500.11 RIPRAP	119-120
500.12 SCOUR	120-121
EXHIBITS	122-126

This page left blank intentionally.

SECTION 500 OPEN CHANNEL FLOW

500.1 INTRODUCTION

Open channels are defined as any conduits in which the flow has a free surface exposed to atmospheric pressure. These conduits are sized to carry the design flow and to maintain the energy conditions of the existing natural channel whenever possible. Open-channel flow includes flow in irrigation ditches, flumes, channel changes, side ditches, rivers, streams, roadside ditches and storm sewers. Included in this chapter are charts for graphical solutions to open-channel problems using the Manning equation, principles of flow in open channels, types of channels, and other explanatory data, which may be helpful in solving various problems pertaining to open-channel flow.

Open channels designed for use in the major drainage system have significant advantages in regard to cost, capacity, multiple use for recreational and aesthetic purposes, and potential for in-stream storage and groundwater recharge. Disadvantages include potential right-of-way constraints and maintenance costs. Careful planning and design are needed to increase the benefits and to minimize the disadvantages.

Hydraulic structures include, stilling basins, channel drops, transitions, baffle chutes, and many other specific drainage works. Their shape, size, and other features vary widely depending upon the function to be served on a specific project. In general, a hydraulic structure is used to retain, regulate, or control the flow of water.

The ideal open channel is a stabilized watercourse developed by nature over time, characterized by stable bed and banks. The benefits of such a channel are:

- A. Available channel storage can decrease peak flows.
- B. Maintenance needs can be low when the channel is properly stabilized.
- C. Natural subsurface infiltration of flows is provided.
- D. Native vegetation and wildlife may not have to be disturbed.
- E. The channel can provide a desirable green belt and recreational area, adding significant social benefits.

Generally speaking, a stabilized natural channel, or the artificial, man-made channel, which most nearly conforms to the character of a stabilized natural channel, is the most efficient and the most desirable.

Channel stability is a problem in urban hydrology because of the significant increase in low flow and peak storm runoff rates. A natural channel must be studied in sufficient detail to determine the measures needed to mitigate potential bottom scour and bank cutting. Erosion control measures, which will preserve the natural appearance of the channel, can be provided at reasonable cost without sacrificing hydraulic efficiency. This section provides the necessary criteria and methodology for selection and design of open channels.

500.2 FLOW OF OPEN CHANNEL

Flow in open channels can be categorized by the following: steady versus unsteady, uniform versus non-uniform, super-critical and sub-critical. Flow is classified as steady if the rate of discharge is not varying with time. It can be further classified as non-uniform if velocity and depth of flow change from section to section. To have uniform flow the grade must be constant and all cross sections of flow must be identical in form, roughness and area. Uniform flow conditions seldom, if ever, occur in nature because channel sections change from point to point. However for practical purposes uniformity can be applied to most stream flow problems.

500.3 DESIGN CRITERIA

500.3.1 Design Frequency

Open channels shall be designed such that flow is contained within channel banks for the 25-year storm, and the minimum finished floor elevation for residential dwellings or public, commercial and industrial buildings shall not be less than one (1) foot above the inundation level for the major storm event, unless the building is flood-proofed.

Channel or adjacent public drainage easement, floodway, etc., shall be capable of carrying the 100 year flood storm.

500.3.2 Maintenance Easement

A dedicated maintenance easement shall be provided with all drainage channels when requested by the City.

500.4 TYPES OF CHANNELS

There are two types of channels, which will be discussed in this chapter – artificial and natural. Natural channels are watercourses, which are found in nature and are not formed by artificial construction methods. These channels include streams, creeks, tributaries, and other natural watercourses. Artificial channels, conversely, are created by construction methods.

500.4.1 Natural Channels

Many natural channels have mild slopes, are reasonably stable, and are not in a state of serious degradation or aggradation. However, if a natural channel is to be used for carrying storm runoff from an urbanizing area, the altered nature of the runoff peaks and volumes from urban development can and will cause scour and erosion. Hydraulic analyses will be required for natural channels in order to identify the erosion tendencies. Some on-site modification of the natural channel may be required to assure a stabilized condition.

The investigations necessary to assure that the natural channels will be adequate are different for every waterway. The engineer/designer must prepare cross sections of the channel, define the water surface profile for the design and major flood, investigate the bed and bank material to determine erosion tendencies, and study the bank slope stability of the channel under flow conditions. Supercritical flow does not normally occur in natural channels, but calculations must be made to assure that the results do not reflect supercritical flow.

500.4.2 Artificial Channels

500.4.2a Grass-Lined Channels

Grass-lined channels are the most desirable of the artificial channels. The grass will stabilize the body of the channel, consolidate the soil mass of the bed, check the erosion on the channel surface, and control the movement of soil particles along the channel bottom. The channel storage, the lower velocities, and the greenbelt multiple-use-benefits obtained create significant advantages over other artificial channels.

500.4.2b Concrete-Lined Channels

Concrete linings must be designed to withstand the various forces and actions, which tend to overtop the bank, deteriorate the lining, erode the soil beneath the lining, and erode unlined areas. Maintenance considerations should be a part of any drainage plan requiring concrete-lined channels. Energy dissipaters may be required where velocities exceed 15 ft/sec.

500.4.2c Rock-Lined Channels

Rock-lined channels are constructed from ordinary riprap or wire enclosed riprap (gabions or Reno Mattresses). The rock lining increases the turbulence resulting in a loss of energy and increased flow retardance. The rock lining also permits a higher design velocity and therefore a steeper design slope than for grass-lined channels. Rock linings are also used for erosion control at culvert/storm drain outlets, at sharp channel bends, at channel confluences, and at locally steepened channel sections. Incorrectly designed rock-lined channels can result in excessive maintenance requirements. Correct sizing of boulders and bedding are essential to good performance. Maintenance considerations should be a part of any drainage plan utilizing rock-lined channels.

500.4.2d Gutters

Gutters are the channels at the edges of the pavement or the shoulders formed by curbs or by shallow depressions. Gutters shall be paved with concrete in accordance with City standards.

500.4.2e Flumes

Flumes are inclined open or closed channels, which convey collected water to a lower level. Open flumes are normally paved with portland cement concrete, bituminous

material, stone or sod, depending upon the volume and velocity of the water to be removed.

500.4.2f Roadway Side Ditches

Roadway side ditches are the channels provided in the cut section to remove runoff from rain falling on the roadway and on the cut slopes, where no curb and gutter is provided. These channels can be grass, rock or concrete paved, depending on the velocity and erosive characteristics of the soil.

500.4.2g Toe of Slope Channels

Toe of slope channels are located when it is necessary to convey water collected by the roadway channel to the point of disposal. When on the downhill side of the highway, this channel can often be laid on a mild slope and the lower end flared to spread the water over the hillside. Where this practice would cause erosion or permit water to drain into the highway embankment, the toe of slope channel must convey the storm water to a natural watercourse.

500.4.2h Intercepting Channels

Intercepting channels are located on the natural ground near the top edge of a cut slope or along the edge of the right-of-way, to intercept the runoff from a hillside before it reaches the roadway or cut slope. Intercepting the surface flow reduces erosion of cut slopes, lessens silt deposition and infiltration in the roadbed area, and decreases the likelihood of flooding of the highway in severe storms.

500.4.2i Median Swales

Median swales are the shallow depressed areas at or near the center of medians used to drain the median area and portions of the roadway. The depressed area of swale is sloped longitudinally for drainage, and at intervals the water is intercepted by inlets and discharged from the roadway. It is not necessary that the longitudinal slope of the swale conform to the pavement grade, particularly on flat grades.

500.5 CHANNEL DISCHARGE

Understanding the basic concepts of open channel flow is necessary to properly design channels. In open channel flow, the water surface is not confined. Surface configuration, flow pattern and pressure distribution within the flow depends on gravity.

500.5.1 Continuity

When dealing with open-channel flow, two important factors to consider are continuity and energy. Continuity of flow must be satisfied in all flow problems, and energy provides the basis for water to flow in an open channel, and determines what it will do at certain points downstream.

500.5.2 Continuity Equation

Continuity states the fact that no fluid is lost or gained and no cavities are formed or destroyed as the fluid passes through a conduit. When the fluid is essentially incompressible (as we assume water to be), continuity may be expressed as follows:

$$Q = A_1V_1 = A_2V_2 = A_nV_n$$

where

Q = the discharge, A_1V_1 , A_2V_2 and A_nV_n are cross sectional areas multiplied by average velocities of sections 1, 2, and any section n , respectively.

Summarily, then, the flow is equal across any two sections in the conduit.

500.5.3 Bernoulli Equation

The basic principle, which is used most often in hydraulics is the law of conservation of energy as expressed by the Bernoulli equation. In essence, the equation is a way of expressing the rate of energy dissipation in pipes and other open channels. When water flows in a channel or conduit it possesses kinetic and potential energy. The potential energy is due to the position of water above some datum line while the kinetic energy is due to velocity of flow. All flowing water has a velocity head, which is equal to:

$$h_v = \frac{V^2}{2g}$$

where

V = mean velocity in feet per second (fps)

g = acceleration of gravity (32.2 feet/sec²) Bernoulli's equation states that the total head or total energy at any section is equal to the total head or total energy at any section downstream, plus any intervening head losses (h_L). Head losses are energy losses due to friction, channel contraction, changes in alignment, etc. The equation is as follows:

$$d_1 + \frac{V_1^2}{2g} + z_1 = d_2 + \frac{V_2^2}{2g} + z_2 + h_L$$

where

d_1, d_2 = depth of flow at upstream and downstream section, respectively

$\frac{V_1^2}{2g}, \frac{V_2^2}{2g}$ = velocity head of upstream and downstream section, respectively

z_1, z_2 = height above datum plane at upstream and downstream section, respectively

h_L = other head losses

Figure 500-1 diagrams the total energy head and lists specific head, which involves the depth of flow and velocity head terms. The total head line is also referred to as the energy gradient, and when the velocity head is subtracted from this line you have the hydraulic gradient.

$$Q = \frac{(1.486) AR^{2/3} S^{1/2}}{n} \quad (500-1)$$

where:

- Q = channel discharge, in cubic feet per second (cfs)
 A = cross-sectional area of channel flow, in square feet (sf)
 R = hydraulic radius of channel, A/WP, in feet (ft)
 WP = wetted perimeter of channel flow, in feet (ft)
 S = slope of the energy gradient, in feet per foot (ft/ft)
 n = Manning's coefficient of channel roughness

A graphical solution for the Manning's Equation is presented on Exhibit 500-1.

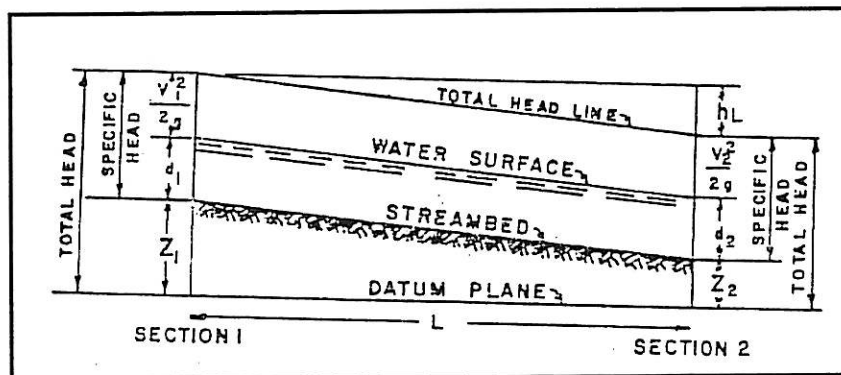

(Source: Arkansas Highway and Transportation Department Drainage Manual)
 Figure 500-1 Water surface profile of channel with uniform flow.

500.5.4 Uniform Flow Calculations

Manning's Equation is an accurate representation of flow conditions only when the rate of flow and channel characteristics (roughness, cross section geometry and slope) remain relatively constant, hence, uniform flow. For a channel of given roughness, discharge and slope, there is only one possible depth for maintaining a uniform flow. This depth is commonly expressed as the normal depth. The corresponding discharge is expressed as the normal discharge. Under uniform flow conditions, the water surface profile is assumed parallel to both the energy grade line and the bottom of the channel.

Uniform flow is most often considered a theoretical abstraction. A channel is commonly designed on the assumption it will convey uniform flow at normal depth, but it is difficult, if not impossible, to evaluate. The actual flow depth can differ from the theoretical uniform flow depth.

Figure 500-1 diagrams the total energy head and lists specific head, which involves the depth of flow and velocity head terms. The total head line is also referred to as the energy gradient, and when the velocity head is subtracted from this line you have the hydraulic gradient.

$$Q = \frac{(1.486) AR^{2/3} S^{1/2}}{n} \quad (500-1)$$

where:

- Q = channel discharge, in cubic feet per second (cfs)
 A = cross-sectional area of channel flow, in square feet (sf)
 R = hydraulic radius of channel, A/WP, in feet (ft)
 WP = wetted perimeter of channel flow, in feet (ft)
 S = slope of the energy gradient, in feet per foot (ft/ft)
 n = Manning's coefficient of channel roughness

A graphical solution for the Manning's Equation is presented on Exhibit 500-1.

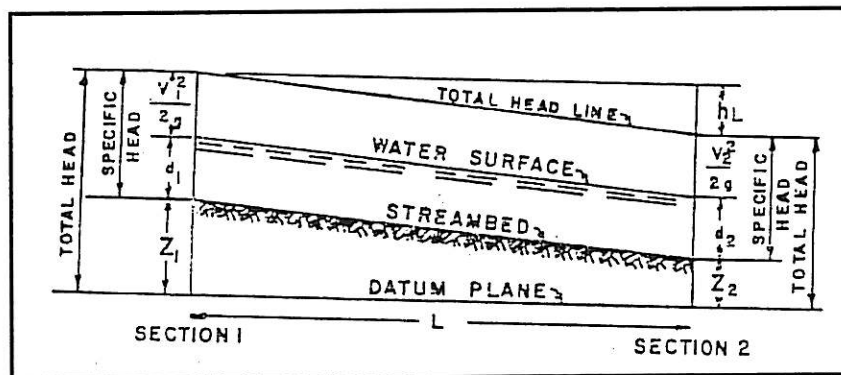

(Source: Arkansas Highway and Transportation Department Drainage Manual)
 Figure 500-1 Water surface profile of channel with uniform flow.

500.5.4 Uniform Flow Calculations

Manning's Equation is an accurate representation of flow conditions only when the rate of flow and channel characteristics (roughness, cross section geometry and slope) remain relatively constant, hence, uniform flow. For a channel of given roughness, discharge and slope, there is only one possible depth for maintaining a uniform flow. This depth is commonly expressed as the normal depth. The corresponding discharge is expressed as the normal discharge. Under uniform flow conditions, the water surface profile is assumed parallel to both the energy grade line and the bottom of the channel.

Uniform flow is most often considered a theoretical abstraction. A channel is commonly designed on the assumption it will convey uniform flow at normal depth, but it is difficult, if not impossible, to evaluate. The actual flow depth can differ from the theoretical uniform flow depth.

500.5.5 Manning's Equation

One the earliest attempts to express energy loss in a pipe was developed by Chezy in 1775. The formula is as follows:

$$V = C (RS)^{1/2}$$

Manning concluded that the c in Chezy's formula should vary with $R^{1/6}$, as follows:

$$C = \frac{1.486 R^{1/6}}{n}$$

where n is a roughness coefficient and R is the hydraulic radius. Substitution of this term into Chezy's formula yields Manning's equation:

$$V = \frac{1.486 R^{2/3} S^{1/2}}{n}$$

where V is the average velocity and S is the average slope of the water surface. By combining the above equation with the continuity equation, discharge can be determined.

$$Q = \frac{1.486 R^{2/3} S^{1/2} A}{n}$$

where

- Q = discharge in cubic feet per second (cfs)
- n = coefficient of roughness (Tables 500-1-3)
- R = hydraulic radius in feet (Flow area / wetted perimeter)
- A = cross-sectional flow area in square feet (sf)
- S = slope of water surface in feet per foot (ft)

The "n" value to be used in the above equation is a function of the type of material from which the channel is constructed. The "n" values to be used in the design of most open channels and pipes are given in Tables 500-1, 500-2 and 500-3 (located in latter portions of this chapter).

A nomograph for the solution of the Manning Equation is shown in Exhibit 500-1.

Guides for maximum permissible velocities in erodible (unlined) channels are given in Tables 500-4 and 500-5.

500.5.6 Froude Number

The ratio of the inertial force of water to its gravitational force yields the Froude Number. It is a dimensionless number, which can be determined from the following formula:

$$F^2 = \frac{V^2}{gR}$$

gd

where:

F = Froude Number
 V = velocity in feet per second (fps)
 d = depth of flow in feet

The Froude number is used to determine whether flow in an open channel is supercritical or subcritical. When $F > 1$ flow is supercritical and when $F < 1$ flow is subcritical.

500.5.7 Critical Flow

Flow is called critical when it occurs at the critical depth in an open channel. Flowing water contains potential and kinetic energy. The relative values of the potential and kinetic energy are important in the analysis of open channel flow. The potential energy is represented by the depth of water plus the elevation of the channel bottom above a datum. The kinetic energy is represented by the velocity head, $V^2/2g$. The specific energy or specific head is equal to the depth of water plus the velocity head.

$$H = d + \frac{V^2}{2g} \quad (500-2)$$

where:

H = specific energy head, in feet (ft)
 d = depth of flow, in feet (ft)
 V = average channel flow velocity, in feet per second (fps)
 g = acceleration of gravity, 32.2 ft/sec²

When depth of flow is plotted against specific energy for a given channel discharge at a section, the resulting curve shows that, at a given specific energy, there are two possible flow depths. At minimum energy, only one depth of flow exists. This is known as the critical depth. At critical depth, the following relationship applies for rectangular sections:

$$d_c = V^2/g \quad (500-3)$$

where:

d_c = critical depth, in feet (ft)
 V = average channel flow velocity, in feet per second (fps)
 g = acceleration of gravity, 32.2 ft/sec²

The effect of gravity upon the state of flow is represented by a ratio of the inertial forces to gravity forces. This ratio is known as the Froude Number (Fr) and is used to categorize the flow. The Froude Number is defined by Equation 500-4 for a rectangular section.

$$Fr = \frac{V}{\sqrt{gd}} \quad (500-4)$$

$$(gd)^{0.5}$$

where:

- Fr = Froude Number
 V = average channel flow velocity, in feet per second (fps)
 g = acceleration of gravity, 32.2 feet per second squared
 d = depth of flow, in feet (ft)

The critical state of flow through a rectangular channel is characterized by several important conditions:

- A. The specific energy is a minimum for a given discharge.
- B. The discharge is a maximum for a given specific energy.
- C. The specific force is a minimum for a given discharge.
- D. The velocity head is equal to half the hydraulic depth in a channel of small slope.
- E. The Froude Number is equal to 1.0.

If the critical state of flow exists throughout an entire reach, the channel flow is critical and the channel slope is at critical slope (S_c). A flow at or near the critical state is unstable, because minor changes in specific energy, such as effects from channel debris, will cause a major change in depth.

In the analysis of nonrectangular channels, the Froude Number equation is rewritten. The depth of flow is defined as the cross sectional area divided by the top width.

$$Fr = \left[\frac{Q^2 B}{g A^3} \right]^{0.5} \quad (500-5)$$

where:

- Fr = Froude Number
 Q = discharge in channel, in cubic feet per second (cfs)
 B = top width of channel, in feet
 g = acceleration of gravity, 32.2 per ft/sec²
 A = cross-sectional area, in square feet

It can be shown that $Fr = 1$ for critical flow. If the Froude Number is greater than 1, the flow is supercritical, but when the Froude Number is less than 1, the flow is subcritical.

500.5.8 Subcritical Flow

To explain subcritical flow, critical depth must first be described. Shown in Exhibit 500-3 is the relationship between the water surface profile and energy profile of any free flowing channel. The specific head energy curve is asymptotic to the line representing the energy due to depth and to the vertical line of zero depth. At the curve's lowest point a horizontal distance is measured from the point to the vertical line of zero depth. This distance is known as critical depth. When the flow occurs at depths greater than critical

depth, the flow is called subcritical. There are formulas, which determine critical depth for a certain type geometric section. Some of these are listed below:

For Rectangular Section:

$$d_c = 0.315 \left[\frac{Q}{B} \right]^{2/3}$$

For Trapezoidal Section:

$$d_c = \frac{4zH_o - 3b + (16z^2H_o^2 + 16zH_ob + 9b^2)^{1/2}}{10z}$$

For Triangular Section:

$$d_c = \frac{0.57(Q)^{2/5}}{(z)}$$

where:

- B = width of rectangular channel in feet
- b = bottom width of a trapezoidal channel in feet
- H_o = specific head at section in feet
- Q = rate of discharge in cfs
- z = slope of sides of a channel (horizontal to vertical)

500.5.9 Supercritical

Just as flow is subcritical when it occurs above critical depth, flow is supercritical when it occurs below critical depth. The change or position where supercritical flow becomes subcritical is very abrupt and is known as a hydraulic jump.

500.5.10 Gradually Varied Flow

Gradually varied flow is used to describe a type of steady non-uniform flow. The change in the depth and velocity occur gradually over a considerable length of channel and the non-uniformity of the flow is not pronounced. The most common occurrence of gradually varied flow in storm drainage is the backwater created by culverts, storm drain inlets, or channel constrictions. For these conditions, the flow depth will be greater than normal depth in the channel and the water surface profile must be computed using backwater techniques.

500.5.11 Rapidly Varied Flow

Rapidly varied flow is characterized by very pronounced curvature of the streamlines. The change in curvature may become so abrupt that the flow profile is virtually broken, resulting in a state of high turbulence. Whereas there are several mathematical solutions to some cases of rapidly varied flow, the practical hydrologist has generally relied on empirical solutions of specific problems. The two cases of rapidly varied flow (weir flow and hydraulic jump) occurring commonly in storm drainage will be discussed in this section.

Weir Flow

The common use of weirs in storm drainage analysis is for spillway outlets in detention ponds. The general form of the equation for horizontal crested weirs is:

$$Q = CLH^{3/2} \quad (500-6)$$

where:

- Q = channel discharge, in cubic feet per second (cfs)
- C = weir coefficient
- L = horizontal length, in feet
- H = total energy head, in feet

Another common weir is the V-notch, whose equation is as follows:

$$Q = C \tan(\theta/2)(H)^{5/2} \quad (500-7)$$

where:

- Q = channel discharge, in cubic feet per second (cfs)
- C = weir coefficient, usually 2.50
- θ = angle of the notch at the apex, in degrees
- H = total energy head, in feet

The weir coefficient is a function of various hydraulic properties and dimensional characteristics of a weir. Experiments have been conducted on various types of weir configurations and formulas have been developed to determine the "C" value. Available empirical formulas are numerous and the designer is urged to solicit hydraulic textbooks, such as Handbook of Hydraulics by Brater and King, and use sound engineering judgment. When designing or evaluating weir flow, the effects of submergence must be considered. A simple check on submergence can be made by comparing the tailwater to the headwater elevations.

Hydraulic Jump

In urban hydraulics, a hydraulic jump may occur at grade control structures (i.e., check drops), inside storm drains or concrete box culverts, or at the outlet of an emergency

spillway for detention ponds. The evaluation of hydraulic jumps is important since there is a loss of energy and erosive forces associated with a jump. For hard-lined facilities such as pipes or concrete channels, the forces and the change in energy can affect the structural stability or the hydraulic capacity. For grass-lined channels, the erosive forces must be controlled to prevent serious damages. The control is usually obtained by check drops or grade control structures, which confine the erosive forces to a protected area.

The analysis of the jump inside of storm drains is approximate due to the lack of data for circular, elliptical or arch sections. The jump can be approximately located by intersecting the energy grade line of the supercritical and subcritical flow reaches. The primary concerns are: 1) if the pipe can withstand the forces, which may separate the joints or damage the pipe wall, and 2) if the jump will affect the hydraulic characteristics. The effect on pipe capacity can be determined by evaluating the energy grade line taking into account the energy lost by the jump. In general, for a Froude Number less than 2.0, the loss of energy is less than 10 percent.

For long box culverts with a concrete bottom, the concerns of the jump are the same as for storm drains. However, the jump can be adequately defined for box culverts/drains and for spillways using the jump characteristics of rectangular sections. A detailed evaluation of the hydraulic jump is beyond the scope of this Manual and the user is referred to other texts for discussion of this subject. The calculations are to be included with the required submittals.

500.6 DESIGN CONSIDERATIONS

Typical channel cross sections are triangular, trapezoidal and parabolic in shape. A triangular channel is a special type of trapezoidal section with a bottom width of zero. Due to the difficulty of maintenance, their application is generally not feasible. Trapezoidal channels of varying bottom widths and side slopes are the most commonly constructed channels. Parabolic channels are generally used only when a vegetated lining is required, although different sections may be selected.

Man-made open channels are commonly designed to have trapezoidal sections of adequate cross sections to incorporate ease of maintenance, uncertainties in runoff estimates, changes in channel roughness coefficients, channel obstructions and sediment accumulations. There are several typical cross sections used for design of grass-lined open channels in urban areas, including channels with alternative trickle channel designs. These channel configurations may be necessary where there are limited right-of-way constraints and where hard lined channels are required.

Determination of a representative Manning's "n" value is critical in the analysis of the hydraulic characteristics of an open channel. The "n" value for each channel reach should be based on the individual channel characteristics. Typical minimum, normal and maximum roughness coefficients for various types of open channels are presented in Table 500-1.

Typical roughness coefficients for a straight channel without shrubbery or trees have been developed by the Soil Conservation Service. It is required that the Manning's "n" in Table 500-2 be used to describe a straight channel roughness for nonlinear channels. Experience and judgment should also be used in selecting the proper "n" value for a channel. When working with a detailed hydraulic model such as HEC-2, "n" values should be calibrated, whenever possible, to known water surface conditions. The designer should expect to use higher values than those listed. The higher values are often required to account for losses due to channel blockage, meander and many other factors not included in the tables.

Table 500-1 Typical Roughness Coefficients for Open Channels

Type of Channel and Description		Min.	Normal	Max.
EXCAVATED OR DREDGED				
a.	Earth, straight and uniform:			
1.	Clean, recently constructed	0.016	0.018	0.020
2.	Clean, after weathering	0.018	0.022	0.025
3.	Gravel, uniform section, clean	0.022	0.025	0.030
4.	With short grass, few weeds	0.022	0.027	0.033
b.	Earth, winding and sluggish:			
1.	No vegetation	0.023	0.025	0.030
2.	Grass, some weeds	0.025	0.030	0.033
3.	Dense weeds or aquatic plants in deep channels	0.030	0.035	0.040
4.	Earth bottom and rubble sides	0.028	0.030	0.035
5.	Stony bottom and weedy banks	0.025	0.035	0.040
6.	Cobble bottom and clean sides	0.030	0.040	0.050
c.	Dragline-excavated or dredged:			
1.	No vegetation	0.025	0.028	0.033
2.	Light brush on banks	0.035	0.050	0.060
d.	Rock cuts:			
1.	Smooth and uniform	0.025	0.035	0.040
2.	Jagged and irregular	0.035	0.040	0.050
e.	Channels not maintained, weeds and brush uncut:			
1.	Dense weeds, high as flow depth	0.050	0.080	0.120
2.	Clean bottom, brush on sides	0.040	0.050	0.080
3.	Same, highest stage of flow	0.045	0.070	0.110
4.	Dense brush, high stage	0.080	0.100	0.140
NATURAL STREAMS				
Minor streams (top width at flood stage < 100 feet)				
a.	Streams on plain			
1.	Clean, straight, full stage, no rifts or deep pools	0.025	0.030	0.033
2.	Same as above, but more stones and weeds	0.030	0.035	0.040
3.	Clean, winding, some pools and shoals	0.033	0.040	0.045
4.	Same as above, but some weeds and stones	0.035	0.045	0.050

Table 500-1 Typical Roughness Coefficients for Open Channels (Cont'd)

Type of Channel and Description		Min.	Normal	Max.
NATURAL STREAMS (Cont'd)				
5.	Same as above, lower stages, more ineffective slopes and sections	0.040	0.048	0.055
6.	Same as 4, but more stones	0.045	0.050	0.060
7.	Sluggish reaches, weedy, deep pools	0.050	0.070	0.080
8.	Very weedy reaches, deep pools, or floodways with heavy stand of timber and underbrush	0.075	0.100	0.150
LINED OR BUILT-UP CHANNELS				
a.	Corrugated Metal	0.021	0.025	0.030
b.	Concrete:			
1.	Trowel finish	0.011	0.013	0.015
2.	Float finish	0.013	0.015	0.016
3.	Finished, with gravel on bottom	0.015	0.017	0.020
4.	Unfinished	0.014	0.017	0.020
5.	Gunite, good section	0.016	0.019	0.023
6.	Gunite, wavy section	0.018	0.022	0.025
7.	On good excavated rock	0.017	0.020	
8.	On irregular excavated rock	0.022	0.027	
c.	Concrete bottom, float finished with sides of:			
1.	Dressed stone in mortar	0.015	0.017	0.020
2.	Random stone in mortar	0.017	0.020	0.024
3.	Cement rubble masonry, plastered	0.016	0.020	0.024
4.	Cement rubble masonry	0.020	0.025	0.030
5.	Dry rubble or riprap	0.020	0.030	0.035
d.	Gravel bottom with sides of:			
1.	Formed concrete	0.017	0.020	0.025
2.	Random stone in mortar	0.020	0.023	0.026
3.	Dry rubble or riprap	0.023	0.033	0.036
LINED OR BUILT-UP CHANNELS (Cont'd)				
e.	Asphalt:			
1.	Smooth	0.013	0.013	
2.	Rough	0.016	0.016	
f.	Rock-lined:			
1.	Riprap	0.023	0.033	0.036
2.	Grouted riprap	0.020	0.023	0.026
3.	Gabions	0.025		0.033

Source: Chow, Ven Te, 1959; Open-Channel Hydraulics

Table 500-3 Manning's Roughness Coefficients for Straight Channels Without Shrubbery or Trees

Grass Condition	Depth of Flow of 0.7 to 1.5 feet	Depth of Flow greater than 3.0 feet
Bermudagrass, Buffalograss, Kentucky Bluegrass:		
a. Mowed to 2 inches	0.035	0.030
b. Length 4-6 inches	0.040	0.030
Good stand, any grass:		
a. Length of 12 inches	0.070	0.035
b. Length of 24 inches	0.100	0.035
Fair stand, any grass:		
a. Length of 12 inches	0.060	0.035
b. Length of 24 inches	0.070	0.035

Source: Chow, Ven Te, 1959; Open-Channel Hydraulics

Where applicable, unlined open channels of a given soil type should have sufficient gradient to provide self-cleaning flow velocities but not be so great as to create excessive erosion. Maximum permissible design flow velocities for earth channels are presented in Table 500-3. Table 500-4 presents maximum permissible velocities for earth channels with varied grass linings and sloping configurations. Lined channels, drop structures, check dams, or concrete spillways may be required to control erosion that results from high channel flow velocities. Overall the design of open channels is tied closely to the criteria for erosion and sediment control.

Table 500-4 Maximum Permissible Design Open Channel Flow Velocities in Earth*

Soil Types	Permissible Mean Channel Velocity (fps)
Fine Sand (noncolloidal)	2.0
Coarse Sand (noncolloidal)	4.0
Sandy Loam (noncolloidal)	2.5
Silt Loam (noncolloidal)	3.0
Ordinary Firm Loam	3.5
Silty Clay	3.5
Fine Gravel	5.0
Stiff Clay (very colloidal)	5.0
Graded, Loam to Cobbles (noncolloidal)	5.0
Graded, Silt to Cobbles (colloidal)	5.5
Alluvial Silts (noncolloidal)	3.5
Alluvial Silts (colloidal)	5.0
Coarse Gravel (noncolloidal)	6.0
Cobbles and Shingles	5.5
Hard Shales and Hard Pans	6.0
Soft Shales	3.5
Soft Sandstone	8.0
Sound rock (igneous or hard metamorphic)	20.0

* These velocities shall be used in conjunction with scour calculations and as approved by the Director of Public Works.

Source: Chow, Ven Te, 1959: Open Channel Hydraulics

**Exhibit 500-6 Maximum Permissible Velocities for Earth Channels with Varied
Grass Linings and Slopes**

Channel Slope	Lining	Permissible Mean Channel Velocity*(fps)
0 - 2%	Small grains (temporary)	2.5
	Western Wheatgrass/Buffalograss	5.0
	Western Wheatgrass/Tall Fescue	5.0
	Western Wheatgrass	5.0
	Bermudagrass	6.0
	Buffalograss/Bluegrama	4.0
5 - 10%	Bermudagrass	6.0
	Western Wheatgrass	5.0

* For highly erodible soils, decrease permissible velocities by 25%.

** Grass lined channels are dependent upon assurances of continuous growth and maintenance of grass.

500.7 DESIGN STANDARDS

The design standards for open channels cannot be presented in a step-by-step fashion because of the wide range of options available to the designer. Certain planning and conceptual criteria are particularly useful in the preliminary design of a channel. These criteria, which have the greatest effect on the performance and cost of the channel, are discussed below. Design submittals shall be in a clear and concise format convenient for review and shall include, but not be limited to, 1) storm runoff computations and mapping, 2) hydraulic design computations, assumptions, references, sketches and drawings, 3) floodplain mapping, 4) and all other pertinent data.

500.7.1 Design of Natural Channels

A natural channel is any watercourse found in nature not formed by artificial construction methods. Natural channels are the final movers of stormwater runoff. When land development creates additional flows, the natural channels must handle the bulk of the additional runoff. It therefore becomes necessary to check the capacity of the natural channel and its ability to drain the area of any additional runoff load.

Generally, natural channels do not have uniform cross-sections throughout their length. Some cross-sections have larger areas than others, some are deeper, and some have structures crossing the flowline. The natural channel will have the capacity to carry a finite amount of flow for every incremental cross-section just before flooding occurs. Flooding at one cross-section is not important so long as the damage done is of little consequence. However, the threat of serious property damage at one location would be a design consideration when natural channels are planned as prime routes for runoff relief.

If a natural channel is to carry additional flows without being improved, then the most restrictive location and respective flow rate should be used as the design maximum capacity of the channel. Tables 500-3 and 500-4, provide some maximum permissible velocities for various type soils in erodible channels. Personal property, livestock, and other roadways should not be endangered by the overflow of the natural channel, so checks should be made for all obvious cross-sections where damage might occur.

The design criteria and evaluation techniques for natural channels are:

- A. The channel shall have adequate capacity for the design storm runoff, and the channel and over bank areas shall have adequate capacity for major storm runoff.
- B. Natural channel segments, which have a Froude Number greater than 0.95 for any flow shall be protected from erosion.
- C. The water surface profiles shall be defined so that the design storm and major storm floodplain can be mapped.
- D. Filling of the flood fringe reduces valuable floodplain storage capacity and tends to increase downstream runoff peaks. Filling of the flood fringe is subject to the restrictions of the city's floodplain regulations.
- E. Roughness factors "n", which are representative of "not maintained" or "in need of maintenance" conditions, shall be used for the analysis of water surface profiles.
- F. Roughness factors "n", which are representative of maintained channel conditions, shall be used to determine velocity limitations.
- G. Erosion control structures, such as riprap, check drops or check dams, may be required to control flow velocities, including the initial storm runoff.
- H. Plan and profile drawings of the design and major storm floodplain, including flooded limits, shall be prepared. Appropriate allowances for future bridges or culverts, which can raise the water surface profile and cause the floodplain to be extended, shall be included in the analysis.

With most natural waterways, grade control structures should be constructed at regular intervals to decrease the slope and control erosion. However, these channels should be left in as near natural condition as possible. For that reason, extensive modifications should not be undertaken unless they are found to be necessary to avoid excessive erosion with subsequent deposition downstream.

The usual rules of freeboard depth, curvature, and other guidelines, which are applicable to artificial channels do not necessarily apply to natural channels. There are significant advantages, which may occur if the designer incorporates into his/her planning the overtopping of the channel and localized flooding of adjacent areas, which are laid out

and developed for the purpose of being inundated during the major storm runoff. The freeboard criteria can be used to an advantage in gauging the adequacy of a natural channel for future changes in runoff.

500.7.2 Grass-Lined Channels

Key parameters in grass-lined channel design include velocity, slopes, roughness coefficients, depth, freeboard, curvature, cross section shape, and lining materials. Other factors such as water surface profile computation, erosion control, drop structures, and transitions also play an important role. A discussion of these parameters is presented below.

A. Flow Velocity and Capacity

The maximum normal depth velocity should not exceed 7.0 feet per second for grass-lined channels, except in sandy soil where the maximum velocity should not exceed 5.0 feet per second. The Froude Number (turbulence factor) shall be less than 0.8 for grass-lined channels. Grass-lined channels having a Froude Number greater than 0.8 shall not be permitted. The minimum velocity should be greater than 2.0 feet per second for self-cleansing.

B. Longitudinal Channel Slopes

Grass-lined channels will have a minimum longitudinal profile slope of 1.5 percent. Grades less than 1.5% require approval by the City Engineer. Where the natural topography is steeper than desirable, drop structures should be utilized to maintain design velocities.

C. Freeboard for Major Drainage ways

Except where localized overflow in certain areas is desirable for additional ponding benefits or other reasons, the freeboard should be:

$$H_{FB} = 1.0 + V^2/2g \quad (500-9)$$

where:

- H_{FB} = freeboard height, in feet
 V = average channel flow velocity, in feet per second (fps)
 g = acceleration of gravity, 32.2 ft/sec²

D. Curvature

The centerline curvature should have a radius twice the top width of the design flow, but not less than 100 feet unless otherwise approved by the City Engineer.

E. Cross Sections

The channel shape may be almost any type suitable to the location and to the environmental conditions. Often, the shape can be chosen to suit open space and recreational needs. However, limitations within which the design must fall for the major storm design flow include:

1. Trickle Channel

The base flow should be carried in a trickle channel. The minimum capacity should be 1.0 percent to 3.0 percent of the 100-year flow, but not less than 1 cfs. Trickle channels shall be constructed of materials to minimize erosion, to facilitate maintenance and to aesthetically blend with the adjacent vegetation and soils.

2. Bottom Width

The minimum bottom width shall be consistent with the maximum depth and velocity criteria. The minimum width should be 4 feet to accommodate the trickle channel.

3. Maintenance Easements

A dedicated maintenance easement shall be provided with all drainage channels when requested by the City.

4. Side Slopes

Side slopes should be 4H:1V or flatter. Steeper slopes may be used in existing developed areas subject to additional erosion protection and approval from the City Engineer.

5. Grass

The grass species chosen must be sturdy, drought resistant, easy to establish and able to spread. A thick root structure is necessary to control weed growth and erosion. Refer to Arkansas Highway and Transportation Department Specification Section 620 for acceptable seeding varieties and broadcast schedules. The Cooperative Extension Office or USDA Soil Conservation Service can provide additional assistance in selecting grass mixtures,

which have been successful, as well as recommending soil preparation, seeding and maintenance methods. Newly constructed channels need a protective cover consisting of mulch and grass seeding immediately after completion. If possible, seed the disturbed areas with permanent grass seed mix. To provide quick ground cover the seed mix may include a perennial ryegrass. The perennial ryegrass germinates quickly and will not compete with the sod-forming grasses later on. When immediate seeding of permanent grass is not practical, an annual crop may be planted with the perennial grass seeded later in the stubble or residue. Rye, oats, or ryegrass gives a fair temporary protection for waterways, though the crop should be clipped before it matures to seed. Second and Third seeding applications may become necessary to assure adequate and acceptable coverage.

500.7.3 Concrete-Lined Channels

The criteria for the design and construction of concrete lined channels is presented below:

A. Freeboard

Adequate channel freeboard above the designed water surface shall be provided and should not be less than that determined by Equation 500-11:

$$H_{FB} = 2.0 + 0.025V(d)^{1/3} \quad (500-11)$$

where:

- H_{FB} = freeboard height, in feet
 V = average channel flow velocity, in feet per second (fps)
 $d^{1/3}$ = depth of flow, in feet

Freeboard shall be in addition to superelevation, standing waves, and/or other water surface disturbances. Concrete side slopes should be extended to provide freeboard. Freeboard should not be obtained by the construction of levees.

B. Velocities

Flow velocities should not exceed 8.0 feet per second or result in a Froude Number greater than 0.9 for non-reinforced linings. Flow velocities should not exceed 18.0 feet per second for reinforced linings.

500.7.4 Rock-Lined Channels

Channel linings constructed from ordinary riprap, grouted riprap, or wire encased rock (gabions) to control channel erosion have been found to be cost effective. Situations for which riprap linings might be appropriate are: 1) where design flows, such as the 25-year flood are found to produce channel velocities in excess of allowable non-eroding values (5.0 feet per second for sandy soil conditions and 7.0 feet per second in erosion resistant soils); 2) where channel side slopes must be steeper than 3H:1V; 3) for low flow channels, and; 4) where rapid changes in channel geometry occur, such as at channel bends and transitions.

A. Ordinary and Grouted Riprap Channel Linings

Many factors govern the size of the rock necessary to resist the forces tending to move the riprap. For the riprap itself, this includes the size and weight of the individual rocks, the shape of the stones, the gradation of the particles, the blanket thickness, the type of Bedding under the riprap, and the slope of the riprap layer.

Hydraulic factors affecting riprap include the velocity, current direction, eddy action and waves. Grouted riprap provides a relatively impervious channel lining which is less subject to vandalism than dumped riprap. Grouted riprap requires less routine maintenance by reducing silt and trash accumulation and is particularly useful for lining low flow channels and steep banks. The appearance of grouted riprap is enhanced by exposing the tops of individual stones and by cleaning the projecting rocks with a wet broom. Grouted riprap should meet all the requirements for ordinary riprap except that the smallest rock fraction (smaller than the 10% size) should be eliminated from the gradation. A reduction of riprap size by 3 inches - 6 inches is permitted for grouted rock.

1. Roughness Coefficient

The Manning's roughness coefficient for ordinary riprap and grouted riprap should be selected using Table 500-1. The "n" value is dependent on the predominant rock size.

2. Rock Size

The design should refer to the Arkansas Highway and Transportation Department (AHTD) Standard Specifications for Highway Construction (current edition) for gradation requirements for riprap.

3. Toe Protection

Where only the channel sides are to be lined, additional riprap is needed to provide for long term stability of the lining. In this case,

the riprap lining should extend at least three feet below the existing channel BPWD and the thickness of the blanket below the existing channel BPWD increased to a depth of at least three (3) times the average boulder diameter to accommodate possible channel scour during floods.

4. Channel Bends

The potential for erosion increases along the outside bank of a channel bend due to the acceleration of flow velocities on the outside part of the bend. Thus, it is often necessary to provide erosion protection in channels which otherwise would not need protection.

The minimum allowable radius for a riprap lined bend is 1.2 times the top width of the design flow water surface and in no case less than 50 feet unless otherwise approved by the City Engineer. The riprap protection should be placed along the outside of the bank and should extend downstream from the bend a distance equal to the length of the bend.

Where the mean channel velocity exceeds the allowable non-eroding velocity so that riprap protection is required for straight channel sections, increase the rock size by three (3) to six (6) inches around bends having a radius less than the greater of the following: two times the top width, or 100 feet. The minimum allowable radius for a riprap lined bend in this case is also 1.2 times the top width of the design flow water surface.

5. Transitions

Scour potential is amplified by turbulent eddies in the vicinity of rapid changes in channel geometry such as transitions and bridges. Riprap protection for subcritical transitions (Froude Number 0.8 or less) is selected by increasing the channel velocity by twenty percent (20%). Since the channel velocity varies through a transition, the maximum velocity in the transition should be used in selecting riprap size after it has been increased by 20%. Protection should extend upstream from the transition entrance a minimum of five (5) feet or 2 times the width of the structure and extend downstream from the transition exit a minimum of ten (10) feet or 4 times the width of the structure.

B. Wire Enclosed Rock (Gabions)

Wire enclosed rock refers to rocks that are bound together in a wire basket so that they act as a single unit, usually referred to as a gabion. One of the major advantages of wire-enclosed rock is that it provides an alternative in

situations where available rock sizes are too small for ordinary riprap. Another advantage is the versatility that results from the regular geometric shapes of wire-enclosed rock. The rectangular blocks and mats can be fashioned into almost any shape that can be formed with concrete. Plastic coated galvanized wire should be specified. The designer should be aware that if the flow contains coarse material, sand or gravel, it may abrade and break the wire basket, enabling the smaller rocks within the gabions to be transported downstream.

C. Bedding Requirements for Rock-Lined Channels

Long term stability of riprap and gabion erosion protection is strongly influenced by proper Bedding conditions. A large percentage of all riprap failures are directly attributable to Bedding failures. A properly designed Bedding provides a buffer of intermediate sized material between the channel BPWD and the riprap to prevent piping of channel particles through the voids in the riprap. Two types of Bedding are in common use: 1) a granular Bedding filter and 2) filter fabric.

1. Granular Bedding

A Bedding of mineral aggregate is adequate for most ordinary riprap, grouted riprap or wire encased riprap applications. The design should refer to the Arkansas Highway and Transportation Department (AHTD) Standard Specifications for Highway Construction (current edition) for granular Bedding requirements.

2. Filter Fabric

Filter fabric has proven to be an adequate replacement for granular Bedding in many instances. Filter fabric provides an adequate Bedding of channel linings along uniform mild sloping channels where leaching forces are primarily perpendicular to the fabric.

Filter fabric is not a complete substitute for granular Bedding. Filter fabric usually provides filtering action only perpendicular to the fabric and usually has only a single equivalent pore opening between the channel BPWD and the riprap. Filter fabric has a relatively smooth surface, which provides less resistance to stone movement. As a result, filter fabric is restricted to slopes no steeper than 2.5H:1V. Tears in the fabric greatly reduce its effectiveness so that direct dumping of riprap on the filter fabric is usually not recommended and care must be exercised during construction.

At drop structures and sloped channel drops, where seepage forces may run parallel with the fabric and cause piping along the bottom surface of the fabric, special care is required in the use of filter

fabric. Seepage parallel with the fabric might be reduced by folding the edge of the fabric vertically downward about two feet (similar to a cutoff wall) at approximately 12 foot intervals along the installation, particularly at the entrance and exit of the channel reach. Filter fabric should be lapped a minimum of 12 inches at roll edges with upstream fabric being placed on top of downstream fabric at the lap.

Fine silt and clay may clog the openings in the filter fabric, preventing free drainage and increasing failure potential due to uplift. For this reason, a granular filter is recommended for fine silt and clay channel BPWDs.

D. Riprap Channel Linings

Design procedures for the design of ordinary and grouted riprap channel linings are presented in the Federal Highway Administration's Hydraulic Engineering Circulars Numbers 11 (HEC-11)¹⁰ and 15 (HEC-15)¹¹. For discharges less than 50 cfs, HEC-15 Design of Roadside Channels with Flexible Linings¹¹ should be used. HEC-11, Design of Riprap Revetments¹⁰, provides the procedures for the design of riprap revetments to be used as channel bank protection and channel linings on larger streams and rivers (i.e. generally greater than 50 cfs).

500.7.5 Other Channel Linings

The criteria for the design of channels with linings other than grass, rock, or concrete will be dependent on the manufacturers recommendations for the specific product. The designer will be required to submit the technical data in support of the proposed material. Additional information or calculations may be requested by the City Engineer to verify assumptions or design criteria. The following minimum criteria will also apply:

A. Flow Velocity

The maximum normal depth velocity will be dependent on the construction material utilized. The Froude number shall be less than 0.8.

B. Freeboard

Same as for grass-lined channels, adjust for horizontal curvature.

C. Curvature

The center line curvature shall have a minimum radius twice the top width of the design flow but not less than 100 feet unless otherwise approved by the City Engineer.

D. Roughness Coefficient

A Manning's "n" value range shall be established by the manufacturers data with the high value used to determine depth/capacity requirements and the low value used to determine Froude Number and velocity restrictions.

E. Cross Sections

Same as for grass-lined channels.

500.8 WATER SURFACE PROFILE ANALYSIS

For final design, water-surface profiles must be computed for all major channels. Computation of the water-surface profile should utilize standard backwater analysis, and should consider all losses due to changes in channel velocity, drops, curves, bridge openings, and other obstructions. Computations begin at a known point, and extend in an upstream direction for subcritical flow.

Backwater computation can be made using the standard step method presented in Open-Channel Hydraulics, by Chow. Many computer programs are available for computation of backwater curves. The most general and widely used program is HEC-2, Water-Surface Profiles, developed by the US Army Corps of Engineers. This program will compute water-surface profiles for natural and manmade channels.

HEC-RAS (River Analysis System) was developed by the U.S. Army Corps of Engineers as an integrated system of software, designed for interactive use. The system is comprised of a graphical user interface (GUI), separate hydraulic analysis components, data storage and management capabilities, graphics, and reporting facilities. The system utilizes similar hydraulic principles as HEC-2 for one-dimensional, gradually-varied, steady flow water surface profile computations. WSPRO, a program developed for the Federal Highway Administration can also be used to analyze one-dimensional gradually varied steady flow in open channels. WSPRO can analyze flow through bridges and culverts, embankment overflow, and multiple-opening stream crossings.

For prismatic channels, the backwater calculation can be computed manually using the Direct Step Method. For an irregular non-uniform channel, the Standard Step Method is used, which is a more tedious iterative process. The use of HEC-2, HEC-RAS, or WSPRO is recommended for nonuniform channel analysis.

The effects of superelevation and energy losses due to resistance in bends in open channels must be considered in backwater computations. In addition to superelevation on bends, flow separation in the bend creates a backwater effect that must also be considered. More detail on determining these effects may be found in Chow.

500.9 FLOOD PROOFING

The National Flood Insurance Program was created to reduce flood losses by promoting a wiser use of the flood plain. In return for making subsidized flood insurance available for existing structures, the participating community agrees to regulate new development in the flood plains. These regulations are adopted by a community in the form of a flood plain ordinance. The ordinance requires all new structures in the flood plain to be protected to a base flood elevation determined either by the Federal Emergency Management Agency (FEMA) or other sources. FEMA's elevations must be used if they are more restrictive. Improvements to existing structures in a flood plain can be elevated or flood proofed to reduce flood damages, at the option and cost of the property owner.

FEMA conducts a Flood Insurance Study (FIS) to determine the base flood elevations and, if appropriate, the floodway boundaries. The base flood is generally defined as the 100-year event, although reference should be made to the City's Flood Hazard Ordinance for the City of Bryant interpretation of the base flood. The 100-year floodplain and corresponding elevations of the 100-year flood can be determined by reviewing the Flood Hazard Boundary Maps and Flood Insurance Rate Maps published by the Federal Insurance Administration. These maps are available for review in the office of the city's floodplain administrator.

Flood proofing is defined by Federal Insurance Administration as any combination of structural and nonstructural additions, changes or adjustments to structures which reduce or eliminate flood damage to real estate or improved real property and sanitary facilities, structures and their contents. The Federal Insurance Administration has published several references to provide detailed criteria and design procedures for flood proofing structures. It is beyond the scope of this Manual to describe flood proofing alternatives and their designs.

500.10 ENERGY DISSIPATERS

Energy dissipaters include hydraulic structures such as stilling basins, channel drops, transitions, baffle chutes, riprap and many other specific drainage works. Their shape, size, and other features vary widely depending upon the function to be served.

It is not the intent of this Section to describe all types of hydraulic structures rather typical hydraulic structures are presented.

Energy dissipaters are often necessary at the end of outfall sewers, culverts or channels. Stilling basins, a type of energy dissipater, are useful at locations where the flow changes from supercritical to subcritical. Stilling basins can reduce or limit potential erosion downstream from a high-velocity channel or conduit.

500.10.1 Impact-Type Stilling Basins

When the energy of flow must be dissipated, the impact-stilling basin is an effective structure for reducing the exit velocity to a tranquil state. A hydraulic jump occurs and energy is dissipated by the stilling basin.

Impact-type stilling basins are subject to local flow turbulences and large dynamic forces, which must be considered in the structural design. The structure must be made sufficiently stable to resist sliding due to the impact load on the baffle wall. The entire structure must also resist the severe vibrations inherent in this type of device and the individual structural members must be sufficiently strong to withstand the large dynamic loads.

500.10.2 Drop Structures

The function of drop structures is to convey water from a higher to a lower elevation and to dissipate excess energy resulting from its fall. In a channel steep enough to cause severe erosion in earth channels or disruptive flow in lined channels, the water can be conveyed through a drop structure designed to safely dissipate the excess energy. Different kinds of drop structures used are vertical, baffled apron, rectangular inclined, and pipe drops.

500.10.3 Chute Structures

Chute structures are commonly used where the drop in elevation is greater than 15 feet. A chute structure usually consists of an inlet, a chute section, an energy dissipater, and an outlet transition. Chutes are similar to drops except that they carry the water over longer distances, over flatter slopes, and through greater changes in grade. The inlet portion of the structure transitions the flow from the channel upstream of the structure to the chute structure. The chute section generally follows the original ground surface and connects to an energy dissipater at the lower end. Stilling pools or baffled outlets are used as energy dissipaters on chute structures. An outlet transition is used when it is necessary to transition the flow between the energy dissipater and the downstream channel.

500.11 RIPRAP

Placement of riprap is used for preventing or limiting channel BPWD and bank erosion damage caused by excessive channel flow or surges from energy dissipaters. Placement of riprap on the channel bottom and banks downstream of an energy dissipater structure is required for alleviating possible undermining of the structure due to scour.

Experience has shown that a primary reason for riprap failure is placement of undersized individual stones in the maximum size range. Failure has also occurred because of improper engineering design for gradation of riprap, seepage control and/or Bedding filter requirements.

The resistance of random riprap to displacement by moving water depends upon:

1. Weight, size, shape, and composition of the individual stones.
2. The gradation of the stone.
3. The depth of water over the stone blanket.
4. The steepness and stability of the protected slope and angle of repose of riprap.

5. The stability and effectiveness of the filter blanket on which the stone is placed.
6. The protection of toe and terminals of the stone blanket.

Design of riprap should take into account the following parameters: 1) stone durability; 2) stone density; 3) stone size; 4) stone shape; 5) stone gradation; 6) velocity of flow against the stone; 7) filter BPWD requirements; 8) channel side slopes; and 9) Froude Number.

A well-graded riprap layer contains about 40 percent of the rock pieces smaller than the required size as stable, or more stable, than a single stone of the required size. Most of the mixture should consist of stones having length, width, and thickness dimensions as nearly equal as practical and should not be flat slabs. The riprap layer should be a minimum of 1-1/2 times or more, as thick as the dimension of the large stones (curve size), and should be placed over a gravel or reverse filter layer.

500.12 SCOUR

Basically, scour is the net result of an imbalance between the capacity of the flow to transport sediment out of an area and the rate of supply of sediment to that area. At a bridge crossing, for instance, the area of interest is the immediate vicinity of the bridge foundation, the piers and abutments. The imbalance of this capacity and supply can arise from a variety of causes which can be generally categorized as 1) those characteristics of the stream itself, and 2) those due to the modification of the flow by the bridge piers and abutments.

Because of the overall complexity of the hydrodynamic forces existing in a natural stream channel, the detailed flow pattern in an unobstructed stream cannot be predicted over time with great accuracy. Reasonable estimates can be made based on observations along reaches of similar streams, and in some cases, actual records and measurements for the particular reach of the stream under investigation can be performed. The designer is encouraged to use the method and procedures in the Federal Highway Administration's publication HEC-18, Evaluating Scour of Bridges to evaluate scour.

Scour, which occurs because of modification of the flow patterns by a bridge crossing, can be further divided into two distinct types of scour depending upon whether or not sediment is supplied to the scour hole. Equilibrium is attained when a scour hole is enlarged to a size where the capacity to remove material from the scour hole is balanced by the rate at which sediment is supplied to the scour hole. During floods, a scour hole located in the main channel will be supplied with sediment at a rate characteristic of the stream. Ignoring the complexities of material stratification that may exist below the stream BPWD, the material supplied will be essentially the same as the material removed.

If no sediment is supplied to the scour hole, equilibrium is not attained until the configuration of the BPWD is such that the scouring capacity of the flow is zero. This condition is most likely to occur in over bank areas where vegetation reduces flow

velocities, causing the coarser material to drop out of suspension, resulting in a greater degree of scour in over bank areas than would otherwise occur in the main channel.

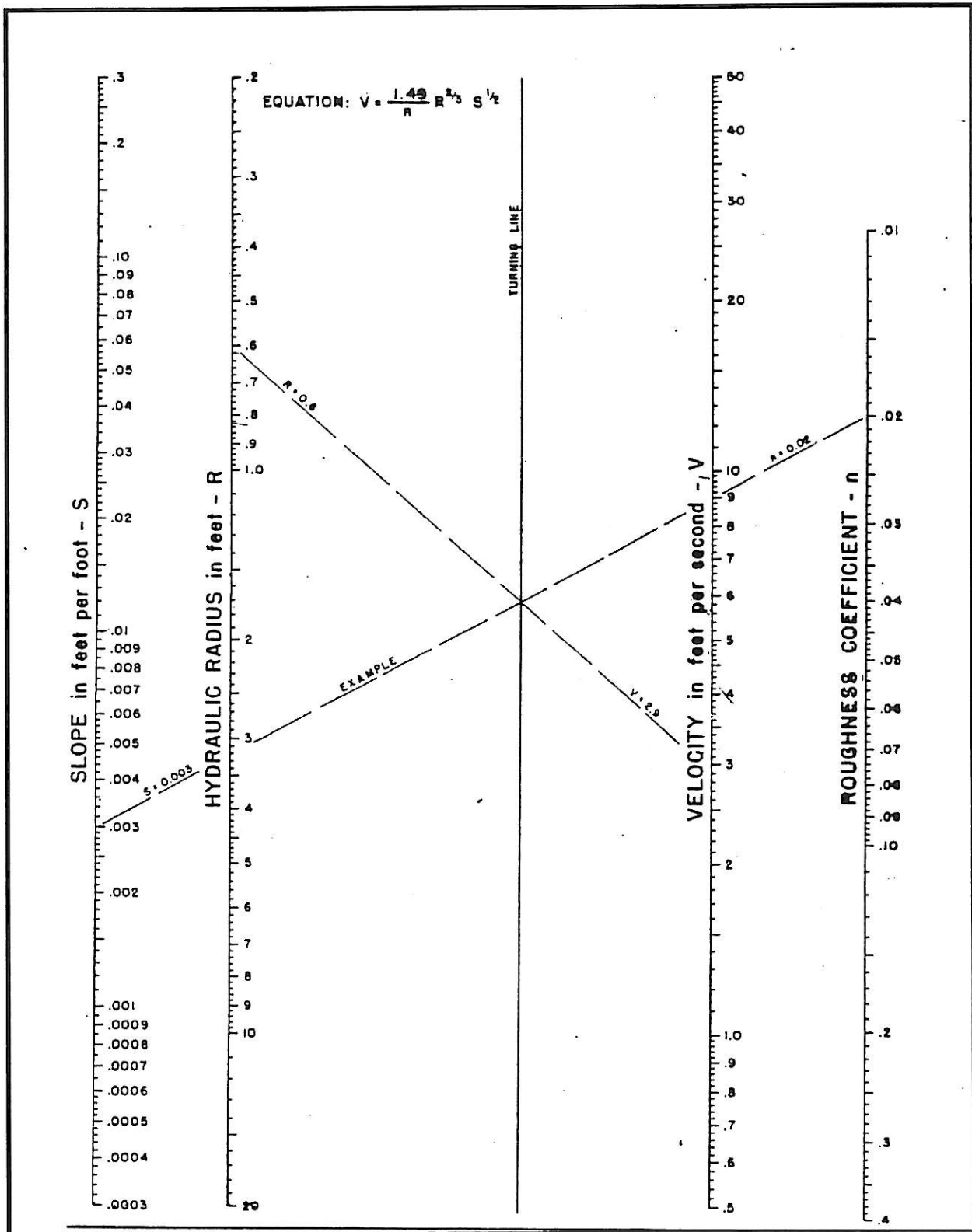

Exhibit 500-1
Nomograph for Solution of Manning Equation
 (Source: Arkansas Highway and Transportation Department Drainage Manual)

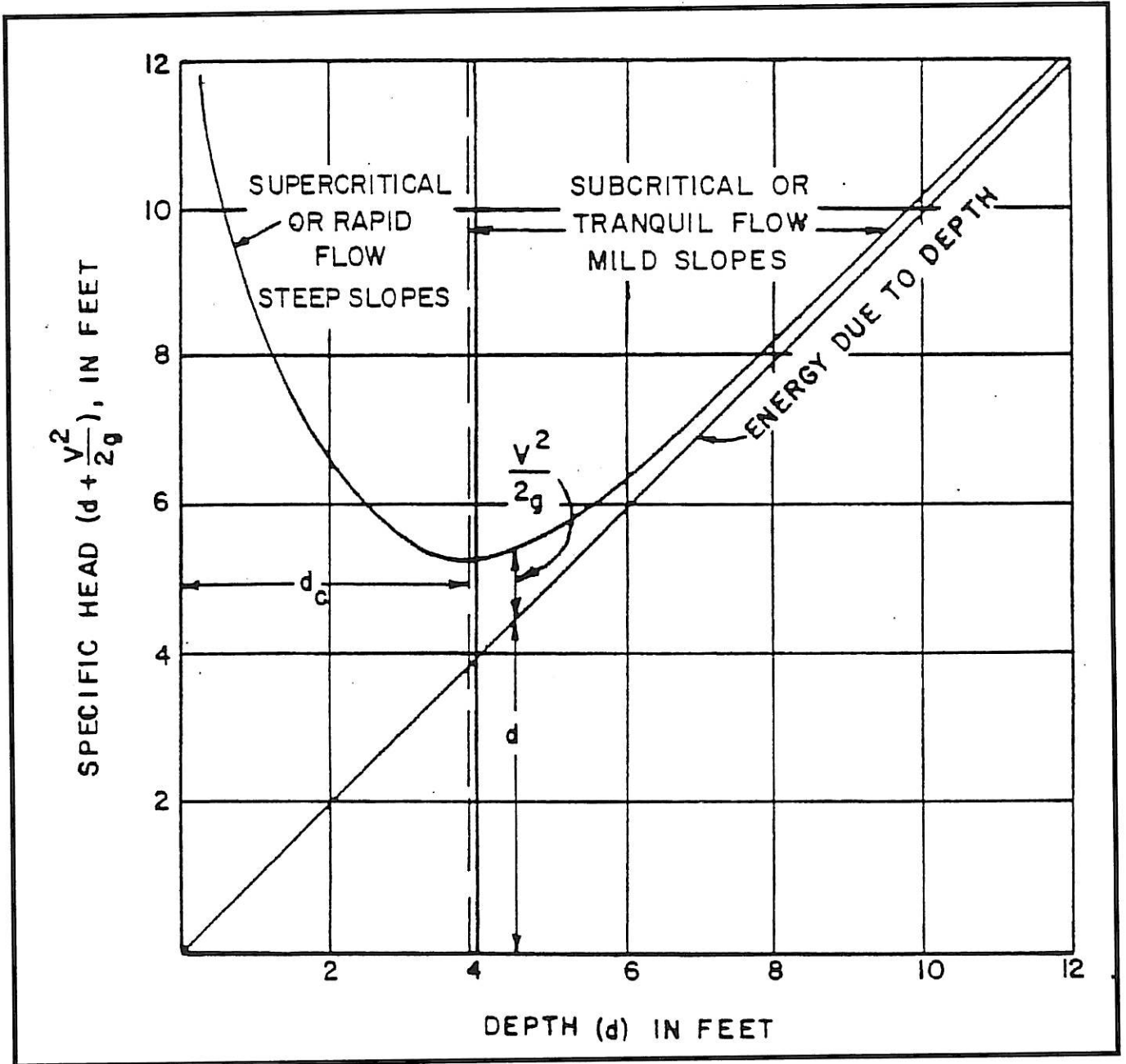

Exhibit 500-2
Specific Head Diagram for Constant Q
(Source: Arkansas Highway and Transportation Department Drainage Manual)

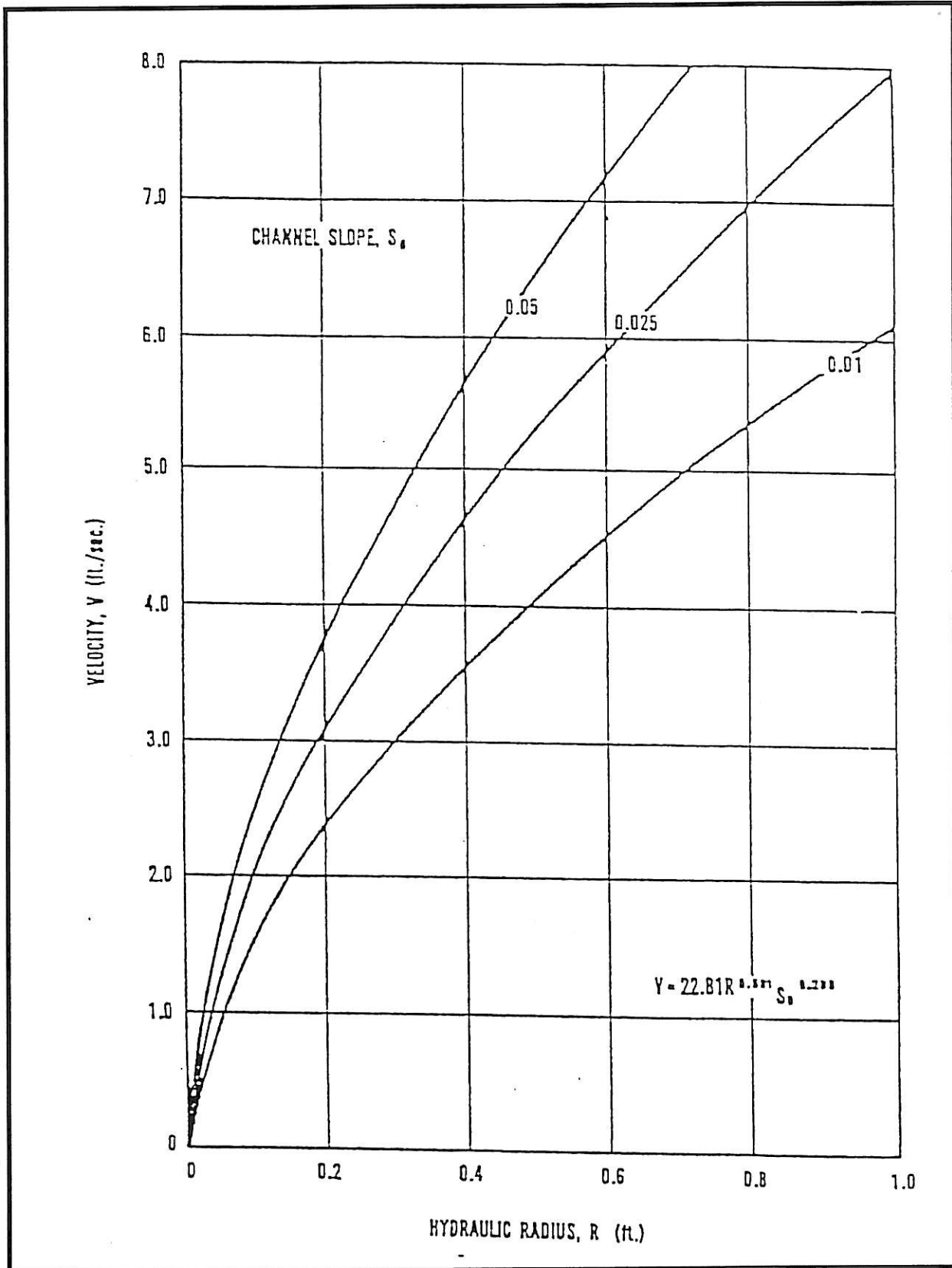

Exhibit 500-3
Flow Velocity for Unlined Channels (Bare Soil)
 (Source: Arkansas Highway and Transportation Department Drainage Manual)

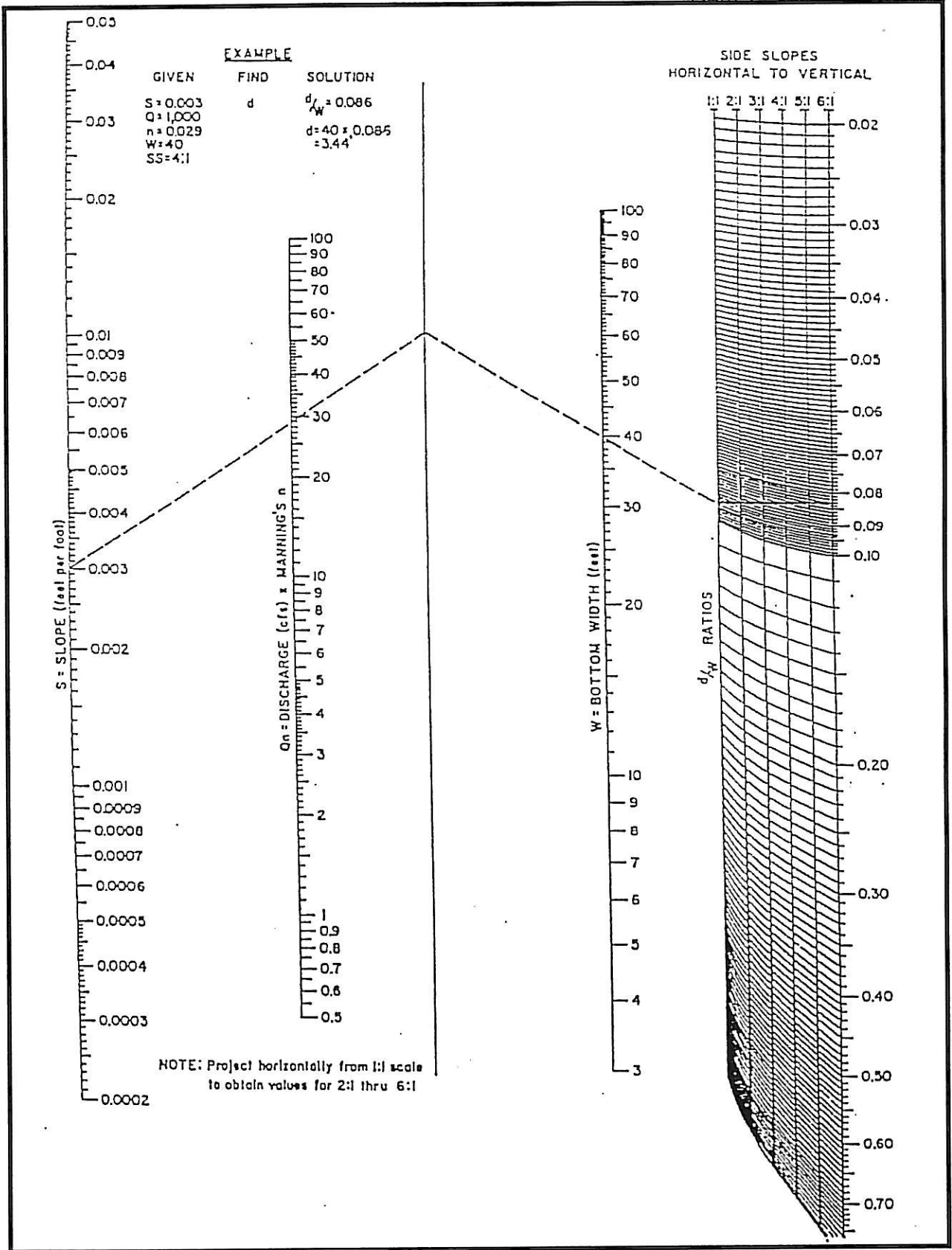
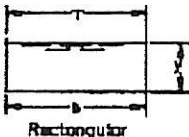
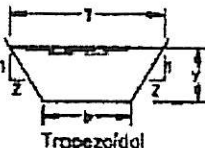
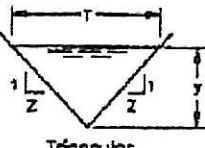
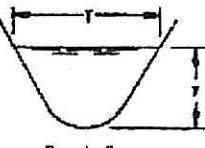

Exhibit 500-4
Uniform Flow for Trapezoidal Channels
(Source: Arkansas Highway and Transportation Department Drainage Manual)

Section	Area A	Wetted Perimeter WP	Hydraulic Radius R	Top Width T
 <p>Rectangular</p>	by	$b + 2y$	$\frac{by}{b + 2y}$	b
 <p>Trapezoidal</p>	$(b + Zy)y$	$b + 2y\sqrt{1 + Z^2}$	$\frac{(b + Zy)y}{b + 2y\sqrt{1 + Z^2}}$	$b + 2Zy$
 <p>Triangular</p>	zy^2	$2y\sqrt{1 + Z^2}$	$\frac{Zy}{2\sqrt{1 + Z^2}}$	$2Zy$
 <p>Parabolic</p>	$\frac{2}{3}Ty$	$T + \frac{8y^2}{3T}$	$\frac{2T^2y}{3T^2 + 8y^2}$	$\frac{3A}{2y}$

Source: Chow, Ven Te, 1959; Open-Channel Hydraulics

Exhibit 500-5
Geometric Elements of Channel Sections

**SECTION 600
STORM SEWER SYSTEMS**

	<u>Page</u>
600.1 INTRODUCTION	128
600.2 GENERAL CRITERIA	128-132
600.3 FLOW IN STORM SEWERS	132-135
600.4 ENERGY GRADIENT AND PROFILE OF STORM SEWERS	135-140
600.5 DESIGN PROCEDURE FOR STORM SEWER SYSTEMS	140-147
EXHIBITS	148-151

SECTION 600 STORM SEWER SYSTEMS

600.1 INTRODUCTION

It is the purpose of this section to consider the significance of the hydraulic elements of storm sewers and their appurtenances to a storm drainage system. Hydraulically, storm drainage systems are conduits (open or enclosed) in which unsteady and non-uniform free flow exists. Storm sewers accordingly are designed for open-channel flow to satisfy as well as make possible, the requirements for unsteady and non-uniform flow. Steady flow conditions may or may not be uniform.

All storm sewer systems shall be designed by the application of the Manning's Equation when flowing in open channel conditions. The hydraulic grade line shall be checked on storm sewer designs to determine if the open channel flow assumption is valid. In the preparation of hydraulic designs, a thorough investigation shall be made of all existing structures and their performance on the waterway in question.

The design of a storm drainage system should be governed by the following seven conditions:

- A. The system must accommodate the surface runoff resulting from the design storm without serious damage to physical facilities or substantial interruption of normal traffic.
- B. Runoff resulting from major storms must be anticipated and discharged with minimum damage to physical facilities and minimum interruption of normal traffic.
- C. The storm drainage system must have a maximum reliability of operation.
- D. The construction costs of the system must be reasonable with relationship to the importance of the facilities it protects.
- E. The storm drainage system must require minimum maintenance and must be accessible for maintenance operations.
- F. The storm drainage system must be adaptable to future expansion with minimum additional cost by the consideration of ultimate development on upstream or existing reaches.
- G. Site design, swales and natural flow features should be utilized to reduce the need for extensive storm sewer systems whenever possible.

600.2 GENERAL CRITERIA

600.2.1 Frequency of Design Runoff

The frequency of design runoff is a function of operational and economic criteria with a special emphasis on public safety. As discussed in other sections of this Manual, some types of facilities do not require high levels of protection and periodic flooding is not objectionable. However, for all facilities, the designer must consider the impact of a 100-year flood and provide for its passage without the loss of life or major property damage.

Refer to Section 400 for guidance on minimum acceptable frequencies of design runoff for storm sewers.

600.2.2 Velocities and Grades

Minimum Grades

Storm sewers should operate with flow velocities sufficient to prevent excessive deposition of solid material, resulting in objectionable clogging. All pipes or boxes should be designed such that velocities of flow will not be less than 3.0 feet per second at design flow or lower. For very flat flow lines the general practice is to design components so that flow velocities will increase progressively throughout the length of the pipe system. Upper reaches of a storm system should have flatter slopes than slopes in lower reaches. Progressively increasing slopes keep solids moving toward the outlet and deters settling of particles due to steadily increasing flow streams. Any variance must be approved by the City Engineer. Table 600-1 gives allowable slope for various size pipes at full and half full flow in order for flow to exceed $V = 3.0$ f.p.s.

TABLE 600-1 Slopes Required for $V = 3.0$ fps at full and half full ($n = 0.013$)

Pipe Size (inches)	Slope in Percent
18	0.26
24	0.17
30	0.13
36	0.10
42	0.08
48	0.07
54	0.06
60	0.05
66	0.05

The minimum slopes are calculated by the modified Manning Formula:

$$S = \frac{(nV)^2}{2.208 R^{4/3}}$$

Where:

S = Slope in ft./ft.

N = Manning's roughness coefficient

V = Velocity in feet per second

R = Hydraulic radius

Maximum Velocities

Maximum velocities in conduits are important mainly because of the possibilities of excessive erosion on the storm sewer inverts. Table 600-2 shows the limits of maximum velocity.

TABLE 600-2 Maximum Velocity in Storm Sewers

Description	Maximum Permissible Velocity
Culverts (all types)	15 fps
Storm Sewers (collectors)	15 fps
Storm Sewers (mains)	12 fps

600.2.3 Pipe Sizes and Material Types

Pipes which are to become an integral part of the public storm sewer system shall have a minimum diameter of 15 inches for gravity flow. Refer to Section 300 for allowable materials, shapes and sizes. If alternate shapes are required for utility clearance or special conditions, the designer must contact the City Engineer for approval. **All pipe design and installation must meet the manufacturer's recommendation for minimum depth of cover, backfill and Bedding.**

A key consideration in selection of pipe material type involves the design life of the pipe. Pipe design life shall be a minimum 50 years as certified by the manufacturer. All manufacturer requirements for which the design life is based must be met by the design engineer. For example, Bedding requirements are critical to meeting the pipe design life. In selecting a roughness coefficient, consideration shall be given to the average conditions during the useful life of the structure. An increased "n" value shall be used primarily in analyzing old conduits where alignment is poor and joints have become rough. If, for example, concrete pipe is being designed at a location and there is reason to believe that the roughness would increase through erosion or corrosion of the interior surface, slight displacement of joints, or entrance of foreign materials, a roughness coefficient should be selected which, in the judgment of the designer, will represent the

average condition. Any selection of "n" values below the minimum or above the maximum, either for monolithic concrete structures or concrete pipe must have the written approval of the City Engineer.

The coefficients of roughness listed in Table 600-3 are for use in the nomographs contained herein, or for direct solution of Manning's Equation.

TABLE 600-3 Roughness Coefficients for Storm Sewers

Materials of Construction	Design Coefficient
Concrete Pipe	0.012
Corrugated Metal Pipe	0.024
HDPE (N12)	0.012
Polymer Coated Spiral Rib Metal Pipe Type 1R	0.012

600.2.4 Stormwater Drainage Structure Location, Size and Castings

A stormwater drainage structure can be either cast in place or precast. They can be either round, square or rectangular. Some common applications for stormwater drainage structures are: junction boxes, curb inlets, surface/grate inlets, yard inlets, and detention structures.

Stormwater drainage structures shall be located at intervals not to exceed 400 feet. Stormwater drainage structures shall be located at conduit junctions, changes in alignment, and ends of curved sections as necessary for maintenance equipment operation.

The maximum size pipe entering a circular drainage structure manhole shall be in accordance with the chart below. These sizes are based on reinforced concrete pipe inside diameter. The required pipe and drainage structure size shall be as follows:

Storm Sewer Pipe Diameter	Minimum Manhole Inside Diameter
15" to 18"	4'
24" to 42"	5'
48" to 54"	6'
60" and larger	To be approved by City Engineer

Larger manhole diameters or a junction structure may be required when storm sewer alignments are not straight through or more than one sewer line goes through manhole.

Properly sized square or rectangular structures are allowed when reinforced.

Stormwater drainage castings shall be heavy duty when subject to traffic loading. All stormwater drainage castings shall meet the current city specifications. All castings shall be custom designed per City specifications.

600.2.5 Pipe Connections

Prefabricated wye and tee connections are discouraged and require approval from the City Engineer.

600.2.6 Alignment

In general, storm sewer alignment between manholes shall be straight. Long radius curves are discouraged, but may be allowed to conform to street alignment. Short radius curves are also discouraged, but may be used on larger pipes in order to reduce head losses at junctions. Curves may be produced by angling the joints or by fabricating beveled ends. Angled joints shall be kept at a minimum to maintain a tight joint. Pipe deflection shall not exceed manufacturer's recommendations, unless precast or cast-in-place bends are specifically designed for deflection.

600.2.7 Utilities

In the design of a storm sewer drainage system, the engineer is frequently confronted with the problem of grade conflict between the proposed storm drain and existing utilities, such as water, gas and sanitary sewer lines.

When conflicts arise between a proposed drainage system and utility system, the owner of the utility system shall be contacted and made aware of the conflict. Any adjustments necessary to the drainage system or the utility can then be determined.

600.3 FLOW IN STORM SEWERS

All storm sewers shall be designed by the application of the Continuity Equation and Manning's Equation, either through the appropriate charts and nomographs or by direct solutions of the equations as follows:

$$Q = AV \quad (600-1)$$

$$Q = (1.49/n)AR^{2/3}S^{1/2} \quad (600-2)$$

where:

Q	=	pipe flow, in cubic feet per second (cfs)
A	=	cross-sectional area of pipe, in square feet
V	=	velocity of flow, in feet per second
n	=	Manning's coefficient of roughness of pipe
R	=	hydraulic radius = A/WP, in feet
WP	=	wetted perimeter, in feet
S	=	friction slope of pipe, in feet per foot (ft/ft)

There are several general rules to be observed when designing storm sewer sections. When followed, they will tend to alleviate or eliminate the common mistakes made in storm sewer design. These rules are as follows:

- A. Select pipe size and slope so that the velocity of flow will increase progressively, or at least will not appreciably decrease, at inlets, bends, or other changes in geometry or configuration.
- B. Do not discharge the contents of a larger pipe into a smaller one, even though the capacity of the smaller pipe may be greater due to steeper slope.
- C. At changes in pipe size from a smaller to a larger pipe, match the crowns (inside top surface) of the two pipes at the same level rather than matching the flow lines. (When necessary for minimal fall, match the 0.8 diameter point of each pipe.)
- D. Conduits are to be checked at the time of their design with reference to critical slope. If the slope of the line is greater than critical slope, the unit will likely be operating under entrance control instead of the originally assumed normal flow. Conduit slope should be kept below critical slope if at all possible. This also removes the possibility of a hydraulic jump within the line.

600.3.1 Pipe Flow Charts

Exhibits 900-14, 900-17, and 900-18 are nomographs for determining uniform flow, critical depth, and velocity in circular concrete conduits. The nomographs are based upon a value of "n" of 0.012 for concrete. For values of "n" other than 0.012, the value of Q should be determined using the applicable Exhibits within Section 900.

600.3.2 Bernoulli Equation

The law of conservation of energy as expressed by the Bernoulli Equation is the basic principle most often used in hydraulics. Energy cannot be lost, thus in a hydraulic system the sum of all energies is a constant. The total energy in mathematical form is Equation 600-4.

$$E = y + (V^2/2g) + P/\gamma \quad (600-4)$$

where:

E	=	total energy head, in feet
y	=	depth of water, in feet
V	=	mean velocity, in feet per second (fps)
P	=	pressure at given location, in pounds per square feet
g	=	acceleration of gravity, 32.2 feet per second squared
γ	=	specific weight of fluid, in pounds per cubic foot

The theorem states that the energy head at any cross-section must equal that in any other downstream section plus the intervening losses. In open channels, the flow is primarily controlled by the gravitational action of the moving fluid, which overcomes the hydraulic energy losses. The Bernoulli Equation defines the hydraulic principles in open channel flow.

$$H = y + V^2/2g + Z + h_f \quad (600-5)$$

where:

H	=	total energy head, in feet
y	=	depth of water, in feet
V	=	mean velocity, in feet per second (fps)
Z	=	height above datum, in feet
h_f	=	head loss, in feet
g	=	acceleration of gravity, 32.2 feet per second squared

The total energy at point one (1) is equal to the total energy at point two (2). The terms are defined as above.

$$y_1 + V_1^2/2g + Z_1 = y_2 + V_2^2/2g + Z_2 + h_f \quad (600-6)$$

The Bernoulli Equation is rewritten for pressure or closed conduit flow. The terms are defined as above.

$$V_1^2/2g + P_1/\gamma + Z_1 = V_2^2/2g + P_2/\gamma + Z_2 + h_f \quad (600-7)$$

Where:

H	=	total energy head
y	=	depth of water
$V^2/2g$	=	velocity head
EGL	=	energy grade line
S_o	=	slope of bottom
h_f	=	head loss
V	=	mean velocity
Z	=	height above datum
HGL	=	hydraulic grade line
S_f	=	slope of EGL
S_w	=	slope of HGL
P/γ	=	pressure head

The sum of the pressure head, P/γ and the elevation head, y , is called the piezometric head. This is the height to which water would rise in a pipe with one of its ends inserted into an arbitrary point in the flow field. The line connecting points of equal piezometric measurements along the path of flow is called the hydraulic grade line.

$$\text{HGL} = P/\gamma + y \quad (600-8)$$

where:

HGL	=	hydraulic grade line, in feet
P/γ	=	pressure head, in feet
y	=	elevation head, in feet

The energy grade line is equal to the hydraulic grade line plus the velocity head, $V^2/2g$.

$$\text{EGL} = P/\gamma + y + V^2/2g \quad (600-9)$$

where:

EGL	=	energy grade line, in feet
P/γ	=	pressure head, in feet
y	=	elevation head, in feet
$V^2/2g$	=	velocity head, in feet

600.4 ENERGY GRADIENT AND PROFILE OF STORM SEWERS

When using Bernoulli's Equation in the hydraulic design of storm sewers, all energy losses must be accounted for. These losses are commonly referred to as head losses, and are classified as either friction losses or minor losses. Friction losses are due to forces between the fluid and the boundary material, while minor losses are a result of the geometry of sewer appurtenances such as manholes, bends, and either expanding or contracting transition. Minor losses can constitute a major portion of the total head loss.

When storm sewer systems are designed for full flow, the designer shall establish the head losses caused by flow resistance in the conduit, changes of momentum and interference at junctions and structures. This information is then used to establish the design water surface elevation at each structure.

It is not necessary to compute the energy grade line of a conduit section if all three of the following conditions are satisfied;

- A. The slope(s) and the pipe size(s) are chosen so that the slope is equal to or greater than friction slope.
- B. The inside top surfaces (crown) of successive pipes are lined up at changes in size.
- C. The water surface at the point of discharge will not rise above the top of the outlet.

In such cases the pipe will not operate under pressure and the slope of the water surface under capacity discharge will approximately parallel the slope of the invert of the pipe.

The City Engineer will determine if the conditions above have been met based upon submitted information.

In the absence of these conditions or when it is desired to check the system against a larger flood than that used in sizing the pipes, the hydraulic and energy grade lines shall be computed and plotted. The friction head loss shall be determined by direct application of Manning's Equation. Minor losses due to turbulence at structures shall be determined by the procedure described below. If the storm sewer system could be extended at some future date, present and future operation of the system must be considered.

The final hydraulic design of a system should be based on the procedures set forth in this Manual. The conduits are treated as either open channel flow or flowing full flow, as the case may be. For open channel flow, the energy grade line is used as a base for calculation, while the hydraulic grade line is used for flowing full flow. The following procedure is applicable to storm sewers flowing with a free water surface, or open channel flow. The basic approach to the design of open channel flow in storm sewers is to calculate the energy grade line along the system. It is assumed that the energy grade line is parallel to the pipe grade and that any losses other than pipe friction may be accounted for by assuming point losses at each manhole.

600.4.1 Friction Head Loss

The pipe friction can be evaluated by modifying the Manning's Equation.

$$S_f = \left[\frac{Qn}{1.49AR^{2/3}} \right]^2 \quad (600-10)$$

where:

S_f	=	slope of pipe, in feet per foot (ft/ft)
Q	=	pipe flow, in cubic feet per second
n	=	Manning's roughness coefficient
A	=	cross-sectional area of pipe, in square feet
R	=	hydraulic radius, A/WP , in feet
WP	=	wetted perimeter, in feet

The pipe friction head loss is equal to the friction slope of the pipe multiplied by the length.

$$h_f = S_L L \quad (600-11)$$

where:

h_f	=	pipe friction head loss, in feet
S_L	=	friction slope of pipe, in feet per foot
L	=	length of pipe, in feet

600.4.2 Minor Head Losses at Structures

The head losses at structures shall be determined for inlets, manholes, wye branches, or bends in the design of full flow closed conduits. Total energy losses at structures include minor losses, h_j , and the change in velocity head, h_v . See Exhibits 600-6 and 600-4 for details of each case. Minimum head loss used at any structure shall be 0.10 feet, unless otherwise approved by the City Engineer.

The basic equations for minor head losses, where there is significant upstream and downstream velocity, takes the form as set forth below with the various conditions of the coefficient, k_m , shown in Tables 600-4, 600-5 and 600-6.

$$h_j = k_m \left[\frac{V_2^2 - V_1^2}{2g} \right] \quad (600-12)$$

where:

h_j	=	junction or structure minor head loss, in feet
k_m	=	junction or structure coefficient of loss, in feet
V_2	=	velocity in downstream pipe, in feet per second (fps)
V_1	=	velocity in upstream pipe, in feet per second (fps)
g	=	acceleration of gravity, 32.2 feet per second squared

In the case where the initial velocity is negligible or when there is no velocity change, the basic equation for head loss becomes:

$$h_f = k_m \left[\frac{V_2^2}{2g} \right] \quad (600-13)$$

The parameters are defined as above.

TABLE 600-4 Junction or Structure Minor Loss Coefficient, k_m

Case Number	Description of Condition	Coefficient k_m
I	Inlet on Main Line	0.50
II	Inlet on Main Line with Branch Lateral	0.25
III	Manhole on Main Line with 45° Branch Lateral	0.25
IV	Manhole on Main Line with 90° Branch Lateral	0.25
V	45° Wye Connection or cut-in	0.75
VI	Inlet or Manhole at Beginning of Line	1.25
VII	Conduit on Curves for 90° *	
	Curve radius = diameter	0.50
	Curve radius = 2 to 8 diameters	0.40
	Curve radius = 8 to 20 diameters	0.25
VIII	Bends where Radius is Equal to Diameter	
	90° Bend	0.50
	60° Bend	0.43
	45° Bend	0.35
	22-1/2° Bend	0.20
	Manhole on Line with 60° Lateral	0.35
Manhole on Line with 22-1/2° Lateral	0.75	

* Where bends other than 90° are used, the 90° bend coefficient can be used with the following percentage factor applied:

60° Bend--85%; 45° Bend--70%; 22-1/2° Bend--40%

Obstructions

The values of the coefficient, k_m , for determining the loss of head due to obstructions in pipes are shown in Table 600-5, and the coefficients are used in the following equation to calculate the head loss at the obstruction:

$$h_j = k_m \left[\frac{V_2^2}{2g} \right] \quad (600-14)$$

where:

h_j = minor head loss, in feet

k_m	=	head loss coefficient
V_2	=	velocity in smaller pipe, in feet per second (fps)
g	=	acceleration of gravity, 32.2 feet per second squared

TABLE 600-5 Head Loss Coefficients Due to Obstructions

A^*/A	k_m
1.05	0.10
1.10	0.21
1.20	0.50
1.40	1.15
1.60	2.40
1.80	4.00
2.00	5.55
2.20	7.05
2.50	9.70
3.00	15.00
4.00	27.30
5.00	42.00
6.00	57.00
7.00	72.50
8.00	88.00
9.00	104.00
10.0	121.00

$\frac{A^*}{A}$ = Ratio of area of pipe to area of opening at obstruction

Expansions and Contractions

The values of the coefficient k_m for determining the loss of head due to sudden enlargements and sudden contractions in pipes are shown in Table 600-6. These coefficients are used in the following equation to calculate the head loss at the change in section:

$$h_j = k_m \left[\frac{V_2^2}{2g} \right] \quad (600-15)$$

where:

h_j	=	minor head loss, in feet
k_m	=	head loss coefficient
V_2	=	velocity in smaller pipe, in feet per second
g	=	acceleration of gravity, 32.2 feet per second squared

TABLE 600-6 Head Loss Coefficients for Expansions and Contractions

D2* D1	Sudden Expansions k _m	Sudden Contractions k _m
1.2	0.10	0.08
1.4	0.23	0.18
1.6	0.35	0.25
1.8	0.44	0.33
2.0	0.52	0.36
2.5	0.65	0.40
3.0	0.72	0.42
4.0	0.80	0.44
5.0	0.84	0.45
10.0	0.89	0.46
	0.91	0.47

* $\frac{D2}{D1}$ = Ratio of larger to smaller diameter.
D1

600.5 DESIGN PROCEDURE FOR STORM SEWER SYSTEMS

600.5.1 Preliminary Design Considerations

The sequence of steps to be used in designing storm sewer systems should include the following:

- A. Prepare a drainage map of the entire area to be drained by proposed improvements which includes streets, lot lines, underground utilities and denote all directions of flow for each lot and street. Contour maps serve as excellent drainage area maps when supplemented by field reconnaissance.
- B. Sketch one or more tentative systems to drain the entire area which includes the streets, storm sewers, locations of minor swales, ditches, and culverts. Also, include the tentative locations of all inlets to the storm sewers.
- C. Outline the drainage area for each inlet in accordance with present and future street development.
- D. Indicate on each drainage area a code identification number, the size of area, the direction of surface runoff by small arrows, and the coefficient of runoff for the area.
- E. Show all existing underground utilities.
- F. Establish design rainfall frequency.
- G. Establish inlet time of concentration and rainfall intensity for each inlet for the design storm.
- H. Establish the typical cross section of each street.

- I. Establish permissible spread of water on all streets within the drainage area.
- J. Include Steps A through I with plans submitted for review. The drainage map submitted shall be suitable for permanent filing and shall be a good quality copy.

600.5.2 Inlet System

Determining the size and location of inlets is largely a trial-and-error procedure. The following steps will serve as a guide for the procedure to be used.

- A. Beginning at the upstream end of the project drainage basin, outline a trial subarea and calculate the runoff from it.
- B. Compare the calculated runoff to allowable street capacity. If the calculated runoff is greater than the allowable street capacity reduce the size of the trial subarea. If the calculated runoff is less than street capacity, increase the size of the trial subarea. Repeat this procedure until the calculated runoff equals the allowable street capacity. This is the first point at which a portion of the flow must be removed from the street. The percentage of flow to be removed will depend on street capacities versus runoff entering the street downstream.
- C. Record the drainage area, time of concentration, runoff coefficient and calculated runoff for the subarea. This information shall be recorded on the plans or in tabular form convenient for review.
- D. If an inlet is to be used to remove water from the street, size the inlet(s) and record the inlet size, amount of intercepted flow, and amount of flow carried over (bypassing the inlet).
- E. Continue the above procedure for other subareas until a complete system of inlets has been established. Compare the time of concentration for a subarea to the time of concentration for the upstream contributing areas. Use the longer time of concentration to calculate the discharge at the inlet. Remember to account for carry-over from one inlet to the next. Add the carry-over to the calculated discharge to obtain the design discharge at the inlet. The difference between the inlet discharge and the design discharge is carry-over flow and is bypassed to the next downstream inlet.
- F. After a complete system of inlets has been established, modification should be made to accommodate special situations such as point sources of large quantities of runoff and variation of street alignments and grades.
- G. Record information as in Steps C and D for all inlets.
- H. After the inlets have been located and sized the inlet pipes can be designed.
- I. Inlet pipes are sized to carry the volume of water intercepted by the inlet. Inlet pipe capacities may be controlled by the gradient available, or by entry conditions of the pipe at the inlet. Inlet pipe sizes should be determined for both inlet and outlet conditions and the larger size thus obtained.

600.5.3 Storm Sewer System

After the computation of the quantity of storm runoff entering each inlet, the storm sewer system required to carry the runoff is designed. It should be kept in mind that the quantity of flow to be carried by any particular section of the storm sewer system is not the sum of the inlet design quantities of all inlets above that section of the system, but is less than the straight total. This situation is due to the fact that as the time of concentration increases the rainfall intensity decreases.

Determining Type of Flow

Before treating conduit as open channel, checks must be made to determine the type of flow. To do this, calculations must proceed upstream, verifying progressively that the hydraulic grade line is below the crown of the pipe.

A. Discharge Point

The discharge point of the storm sewer usually establishes a starting point. If the discharge is submerged, as when the water level of the receiving water body is above the crown of the pipe, the exit loss should be added to the water level and calculations for head loss in the storm sewer started from this point. If the hydraulic grade line is above the pipe crown at the next upstream manhole, full flow calculations may proceed. If the hydraulic grade line is below the pipe crown at the upstream manhole, then open channel flow calculations must be used at the manhole.

When the discharge is not submerged, a flow depth must be determined at some control section to allow calculations to proceed upstream. If the tailwater depth is less than $(D + d_c)/2$, set the tailwater elevation equal to $(D + d_c)/2$, where D equals the pipe in diameter, and d_c equals the critical depth, both in feet, otherwise use the tailwater depth. The hydraulic grade line is then projected to the upstream manhole. Full flow calculations may be utilized at the manhole if the hydraulic grade is above the pipe crown.

The assumption of straight hydraulic grade lines is not entirely correct, since backwater and drawdown exists, but should be accurate enough for the size pipes usually considered as storm sewers. If the designer feels that additional accuracy is justified, as with very large conduits or where the result will have a very significant effect on design, backwater and drawdown curves may actually be calculated.

B. Within System

At each manhole the same type of procedure as outlined for the discharge point must be repeated.

The water depth in each manhole must be calculated to verify that the water level is above the crown of all pipes. Whenever the level is below the crown of a pipe, open channel methods are applicable.

Storm Sewer Pipe

The ground-line profile is used in conjunction with the previous runoff calculations. When the initial energy gradient is established and the design discharge is determined, a Manning's flow chart may be used to determine the pipe size and velocity.

It is probable that the tentative gradient will have to be adjusted at this point since the intersection of the discharge in the slope on the chart will likely occur between standard pipe sizes. The smaller pipe should be used if the design discharge and corresponding slope does not result in an encroachment on the two-foot criteria below the ground surface. If there is an encroachment, use the larger pipe which will establish a capacity somewhat in excess of the design discharge. Velocities can be read directly from a Manning flow chart based on a given discharge, pipe size and gradient slope.

Junctions, Inlets and Manholes

- A. Determine the invert elevations at the upstream end and downstream end of the pipe section in question. The elevation of the invert of the upstream end of pipe is equal to the elevation of the downstream end of pipe (invert) plus the product of the length of pipe and the pipe gradient, S_o .
- B. Determine the velocity of flow for incoming pipe (main line) at junction, inlet, or manhole at design point.
- C. Determine the velocity of flow for outgoing pipe (main line) at junction, inlet, or manhole at design point.
- D. Compute velocity head for outgoing velocity (main line) at junction, inlet, or manhole at design point.
- E. Compute velocity head for incoming velocity (main line) at junction, inlet, or manhole at design point.
- F. Determine head loss coefficient, k_m , at junction, inlet, or manhole at design point from Tables 600-4, 600-5, 600-6 or Figures 600-5 and 600-6.
- G. Compute head loss at junction, inlet or manhole.

$$h_j = k_m \left[\frac{V_2^2 - V_1^2}{2g} \right] \quad (600-12)$$

- H. Compute energy gradient at upstream end of junction as if junction were not there.
- I. Add head loss to energy gradient elevation determined to obtain energy gradient elevation at upstream end of junction.

All information shall be recorded on the plans or in tabular form convenient for review.

600.5.4 Proportioning Storm Sewer Pipes

The computations involved in proportioning various runs of sewer pipe are summarized in the tabulation sheet titled “Storm Sewer Computations”, Exhibit 600-1.

- Column 1 Inlet Number – Enter the inlet number
- Column 2 Inlet Location – Enter the station and location of the inlet.
- Column 3 Inlet CA from the Inlet Flow Calculation Table, Exhibit 800-12, the quotient of Column 25 ÷ Column 6 or Column 27, is used to obtain the CA product to be entered in Column 3. Only structures contributing flow to the system should have values in Column 3.
- Column 4 Other CA – Enter the CA product of flow from any contributing upstream structure.
- Column 5 Structure No. – Number the inflowing structure.
- Column 6 Total CA – Enter the sum of Columns 3 and 4.
- Column 7, 8 and 9 The time of concentration is the time required for water to flow from the most remote part of the drainage area or areas involved to the upper end of the pipe run under consideration. The first run Time of Concentration is the inlet time for the first inlet. For all succeeding runs, Time of Concentration may be either the time as computed along the sewer line or the inlet time of the inlet at the beginning of the run under consideration, depending upon which of these two periods is longer. Accordingly, the larger of the two is used in determining “I” and “Q”, unless this larger value is less than 10 minutes, in which case the established minimum time of 10 minutes is used.
The Time of Concentration shown in Column 7 is computed by taking the time of concentration for the preceding run and adding it to the time required for water to flow through the preceding run to the beginning of the run under consideration.
At junctions of lines, the larger value of the time of concentration is used.
- Column 10 i – Rainfall intensity in inches per hour for the design storm. Base on T_c . See Exhibit 400-4.
- Column 11 Q_i = Total flow in pipe in CFS. Equal to the product of Column 6 times Column 10.
- Columns 12, 13, 14 & 15 Pipe Characteristics – The size and gradient of pipe as show in Columns 12 and 14 must be chosen in such manner that the pipe when flowing full, but not under head, will carry an amount of water approximately equal or greater than the computed discharge, “Q”. In other words, the “Capacity” show in Column 15 must be approximately equal to or greater than the value “Q” shown in Column 11.
The capacity may be calculated by Manning’s formula:

$$Q=(1.49/n)AR^{2/3}S^{1/2}$$

or capacity can be taken directly from the appropriate nomographs in Section 900. Whenever a pipe run is designed in such a manner that the capacity of a pipe as shown in Column 15 is less than the computed discharge shown in Column 11, a check of the hydraulic gradient above this run should be made to make sure that the backwater head created by such a design is not large enough to cause blowouts at inlets or junctions above the run.

Column 16 The velocities shown in this column can be calculated by Manning's formula:

$$V=(1.49/n)R^{2/3}S^{1/2}$$

or the velocities can be taken directly from the appropriate graphs or figures in Section 900.

Column 17 L – The length of each run as shown in this column is the length center to center of inlets or junctions in feet. This length is used in determining the time of flow from one inlet or junction to another.

Column 18 Pipe T_c – The Time of Concentration in the pipe under consideration is actual flow time, in minutes from the present inlet to the next junction point. Run time is calculated by dividing the length of run (Column 17) by velocity of flow (Column 16) and converting the answer to minutes by dividing by 60.

Column 19 These columns are believed to be self-explanatory.
to 24

600.5.5 Hydraulic Grade Line

The final step in designing a storm sewer is to check the hydraulic grade line (HGL). Computing the HGL will determine the elevation under design conditions to which water will rise in various inlets, manholes, junctions and etc.

The HGL should be computed for all storm sewer systems. Computations are summarized in the tabulation sheet entitled "Hydraulic Grade Line", Exhibit 600-2.

Column 1 Inlet Station – Enter the station for the junction immediately upstream of the outflow pipe. HGL computations begin at the outfall and are worked upstream taking each junction into consideration.

Column 2 Outlet Water Surface Elevation – Enter tailwater elevation in feet if the outlet will be submerged during the design storm or 0.8 diameter of pipe plus invert out elevation of the outflow pipe, whichever is greater.

Column 3 D_o – Enter diameter of outflow pipe in inches.

Column 4 Q_o – Enter design discharge for outflow pipe in CFS.

Column 5 L_o – Enter length of outflow pipe in feet.

Column 6 S_{f0} – Enter friction slope in feet/foot of the outflow pipe using the Manning's formula:

$$S_f = \left[\frac{Q_n}{1.49AR^{2/3}} \right]^2 \quad (600-10)$$

Column 7 H_f – Enter friction loss by multiplying Column 5 by Column 6.

Column 8 V_o – Enter velocity of the outflow pipe in feet per second.

Column 9 Q_i – Enter design discharge ($Q_1, Q_2, Q_3 \dots$) in CFS for each pipe flowing into the junction.

Column 10 V_i – Enter velocity ($V_1, V_2, V_3 \dots$) in feet per second for each pipe flowing into the junction.

Column 11 H_{tm} – Enter terminal junction losses in feet for the upper reach of each storm sewer run using the formula:

$$H_{fm} = V^2/2g$$

Column 12 H_e – Enter pipe entrance losses in feet for the upper reach of each storm sewer run using the formula:

$$H_e = (KV^2)/2g$$

where:

$$K = 0.5 \text{ for square - edge}$$

Column 13 Enter junction losses H_{j1} or H_{j2} in feet for each junction using the formula:

$$H_{j1} = V^2 \text{ outflow}/2g$$

or:

$$H_{j2} = \frac{Q_4V_4^2 - Q_1V_1^2 - Q_2V_2^2 + KQ_1V_1^2}{2gQ_4}$$

Column 14 H_b – Enter bend losses (changes in direction of flow) in feet for each inflowing pipe to the outflow pipe using the formula:

$$H_b = KV^2/2g$$

Refer to Section 500 for "K" values.

- Column 15 H_t – Enter total head losses in feet using the formula:
$$H_t = H_f + H_{tm} + H_e + H_{j1} \text{ or } H_{j2} + H_b$$
- Column 16 HGL – Enter the new Hydraulic Grade in feet by summing elevations in column 2 and column 15. This elevation is the potential water surface elevation for the junction under design conditions.
- Column 17 Enter the top of junction cover or the gutter flow line, whichever is the lowest and compare it with the HG in Column 16.

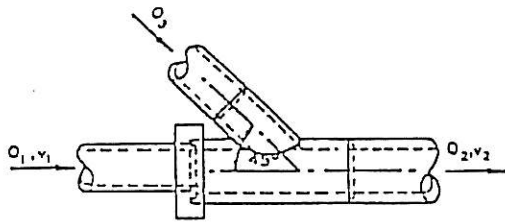

PLAN

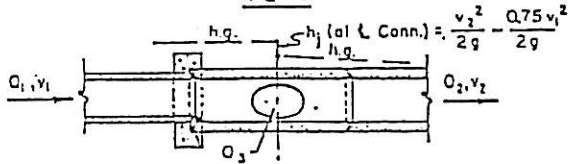

SECTION

CASE V
45° WYE CONNECTION
OR CUT IN

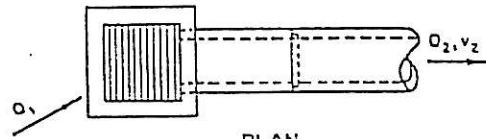

PLAN

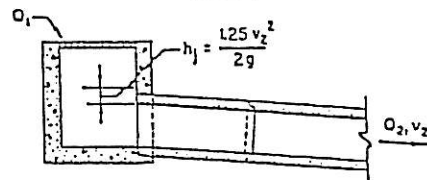

SECTION

CASE VI
INLET OR MANHOLE AT
BEGINNING OF LINE

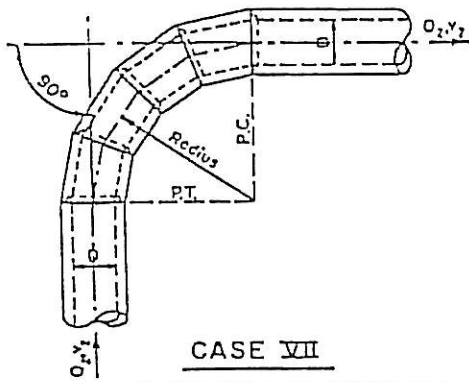

CASE VII

CONDUIT ON 90° CURVES ‡

NOTE: Head loss applied at P.C. for length of curve.

Radius = Dia. of Pipe $h_j = 0.50 \frac{v_2^2}{2g}$

Radius = (2-8) Dia. of Pipe $h_j = 0.25 \frac{v_2^2}{2g}$

Radius = (8-20) Dia. of Pipe $h_j = 0.10 \frac{v_2^2}{2g}$

Radius = Greater than 20 Dia. of Pipe $h_j = 0$

‡ When curves other than 90° are used, apply the following factors to 90° curves.

60° curve 85%

45° curve 70%

22½° curve 40%

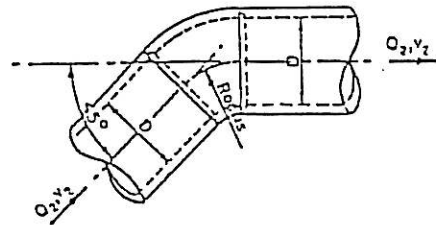

CASE VIII

BENDS WHERE RADIUS IS
EQUAL TO DIAMETER OF PIPE

NOTE: Head loss applied at beginning of bend

90° Bend $h_j = 0.50 \frac{v_2^2}{2g}$

60° Bend $h_j = 0.43 \frac{v_2^2}{2g}$

45° Bend $h_j = 0.35 \frac{v_2^2}{2g}$

22½° Bend $h_j = 0.20 \frac{v_2^2}{2g}$

Exhibit 600-3

Minor Head Losses Due to Turbulence at Structures

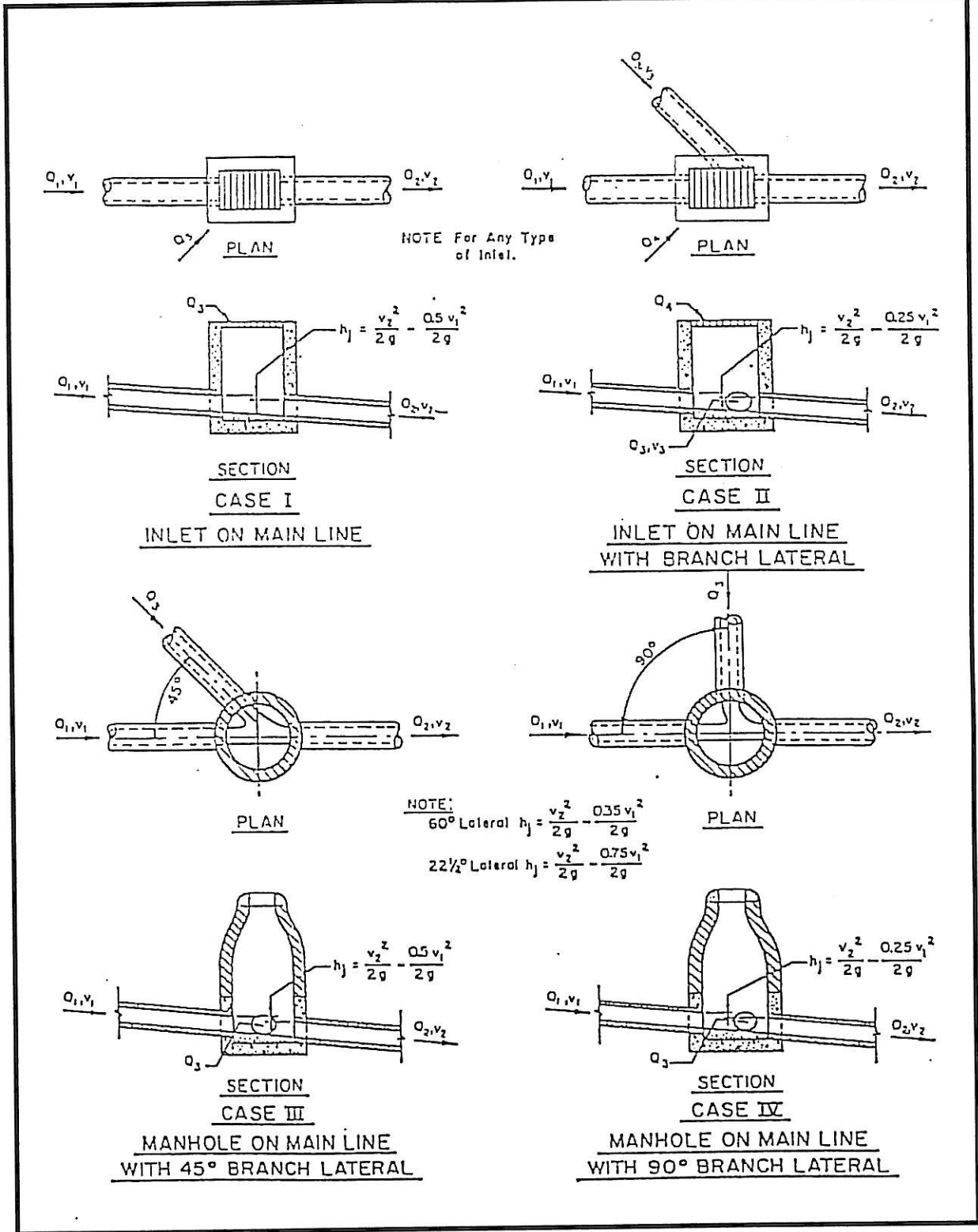

Exhibit 600-4
Minor Head Losses Due to Turbulence at Structures

**SECTION 700
STREET DRAINAGE**

	<u>Page</u>
700.1 INTRODUCTION	153
700.2 EFFECTS OF STORM WATER ON STREET CAPACITY	153-156
700.3 DESIGN CRITERIA	156-165
EXHIBITS	166-169

SECTION 700 STREET DRAINAGE

700.1 INTRODUCTION

Roadways or streets in the urban areas of the City of Bryant serve an important and necessary drainage service even though their primary function is for the movement of traffic. However, good planning of streets can substantially help in reducing the size of, and sometimes eliminate the need for a storm drainage system in newly urbanized areas. Traffic and drainage uses are compatible up to a point, beyond which drainage must be secondary to traffic needs. The design of street drainage facilities shall account for the maximum capacity of downstream facilities in order to minimize the risk of downstream flooding.

700.2 EFFECTS OF STORM WATER ON STREET CAPACITY

The storm runoff which influences the traffic capacity of a street can be classified as follows:

- A. Sheet flow across the pavement as falling rain flows to the edge of the pavement.
- B. Runoff flowing adjacent to the curb.
- C. Storm water ponded at low points.
- D. Flow across the traffic lane from external sources, or cross-street flow (as distinguished from water falling on the pavement surface).
- E. Splashing of any of the above types of flow on pedestrians.

Each of these types of storm runoff must be controlled within acceptable limits so that the street's main function as a traffic carrier will not be unduly restricted. The effect of each of the above categories of runoff on traffic movement are discussed in the following sections.

700.2.1 Interference Due to Sheet Flow Across Pavement

Rainfall, which falls upon the paved surface of a street or road must flow overland as sheet flow until it reaches a channel. Channels can be created either by curbs and gutters or by roadside ditches. The direction of flow on the street may be determined by the vector addition of the street grade and the crown slope, which is equivalent to drawing the perpendicular to a contour line on the road. The depth of sheet flow will be essentially zero at the crown of the street and will increase as it proceeds toward the channel. Traffic interference due to sheet flow is essentially of two types: hydroplaning and splash.

Hydroplaning

Hydroplaning is the phenomenon of vehicle tires actually being supported by a film of water, which acts as a lubricant between the pavement and the vehicle. It generally occurs at speeds commensurate with arterial streets and its effect can be minimized by achieving a relatively rough pavement, which will allow water to escape from beneath the tires by pavement grooving to provide drainage, or by reducing travel speed.

Splash

Traffic interference due to splash results from sheet flow of excessive depth caused by water traveling a long distance or at a very low velocity before reaching a gutter. Increasing the street crown slope will decrease both the time and distance required for water to reach the gutter. The crown slope, however, must be kept within acceptable limits to prevent side-slipping of traffic during frozen surface conditions and to allow the opening of doors when parked adjacent to curbs. An exceedingly wide pavement section contributing flow to one curb will also affect the depth of sheet flow. This may be due to superelevation of a curve, off-setting of the street crown due to warping of curbs at intersections, or several traffic lanes between street crown and the gutter. Consideration should be given to all of these factors to maintain a depth of sheet flow within acceptable limits.

700.2.2 Interference Due to Gutter Flow

Water, which enters a street, either sheet flow from the pavement surface or overland flow from adjacent land areas, will flow in the gutter of the street until it reaches an outlet, such as a storm drain or a channel. As the flow progresses downhill and additional areas contribute to the runoff, the width of flow will increase and progressively infringe upon the traffic lane. If vehicles are parked adjacent to the curb, the width of spread will have little influence on traffic until it exceeds the width of the vehicle by several feet. However, on streets where parking is not permitted, as with many arterial streets, whenever the flow width exceeds a few feet it will significantly affect traffic. Field observations show that vehicles will crowd adjacent lanes to avoid curb flow.

As the flow width increases, it becomes impossible for vehicles to operate without driving through water, and they again begin to use the inundated lane. At this point the traffic velocities will be significantly reduced as the vehicles begin to drive through the deeper water. Splash from vehicles traveling in the inundated lane obscures the vision of drivers of vehicles moving at a higher rate of speed on the open lane.

Eventually, if width and depth of flow become great enough, the street will become ineffective as a traffic carrier. During these periods, it is imperative that emergency vehicles such as fire trucks, ambulances, and police cars be able to traverse the street by moving along the crown of the roadway.

The street classification is also important when considering the degree of interference to traffic. A residential street, and to a lesser extent a collector street, could be inundated with little effect upon vehicular travel. The small number of cars involved could move at

a low rate of speed through the water even if the depth were four to six inches. However, reducing the speed of arterial traffic affects a greater number of private, commercial, and emergency vehicles.

700.2.3 Interference Due to Ponding

Storm runoff ponded on the street surface because of a change in grade or the crown slope of intersecting streets has a substantial effect on traffic. A major problem with ponding is that it may reach depths greater than the curb and remain on the street for long periods of time. Another problem is that ponding is localized in nature and vehicles may enter a pond moving at a high rate of speed. The manner in which ponded water affects traffic is essentially the same as for curb flow; the width of spread onto the traffic lane is the critical parameter. Ponded water will often bring traffic on a street to a complete halt. In this case, incorrect design of only one facet of an entire street and storm drainage system will render the remainder of the street system useless during the runoff period.

700.2.4 Interference Due To Water Flowing Across Traffic Lanes

Whenever storm runoff moves across a traffic lane, a serious impediment to traffic flow occurs. The cross flow may be caused by superelevation of a curve or a street intersection exceeding the capacity of the higher gutter on a street with cross fall. The problem associated with this type of flow is the same as for ponding in that it is localized in nature and vehicles may be traveling at high speed when they reach the location. If the velocity of vehicles is naturally slow and use is light, such as on residential streets, cross-street flow does not cause sufficient interference to be objectionable.

The depth and velocity of cross-street flow should always be maintained within such limits that it will not have sufficient force to affect moving traffic. If a vehicle which is hydroplaning enters an area of cross street flow, even a minor force could be sufficient to move it laterally towards the gutter.

At certain intersections the flow may be trapped between converging streets and must either flow over one street or be carried underground. If the vehicles crossing the intersection are required to stop, then very little hazard exists to the traveling public. This is the basis for the assumption that valley gutters are acceptable across a residential street where it intersects another residential or collector street. Another point in favor of the use of valley gutters is the continuation of the grade of the dominant street. If the crown of the residential street is allowed to coincide with the crown of the major street, the outside traffic lanes of the major street will have a "hump" at the intersection, which is not preferred.

700.2.5 Effect on Pedestrians

In areas where pedestrians frequently use sidewalks, splash due to vehicles moving through water adjacent to the curb is a serious problem. It must also be kept in mind that under certain circumstances, pedestrians will be required to cross ponded water adjacent to curbs.

Since the majority of pedestrian traffic will cease during the actual rainstorm, less consideration need be given to the problem while the rain is actually falling. Ponded water, however, remaining after the storm has passed, must be negotiated by pedestrians. Streets should be classified with respect to pedestrian traffic as well as vehicular traffic. As an example, streets, which are classified as residential for vehicles and located adjacent to a school are arterials for pedestrian traffic. Allowable width of gutter flow and ponding should reflect this fact.

700.3 DESIGN CRITERIA

The depth of flow in the street shall be limited to a maximum of 6" or the top of curb, which ever is less except in FEMA controlled floodplains, where FEMA guidelines shall govern.

Design criteria for the collection and transport of runoff on public streets is based on a reasonable frequency of traffic interference. That is, depending on the street classification, certain traffic lanes can be fully inundated once during the design storm return period. For example, a residential street is allowed to flood to a curb depth of 6-inches during a 10-year frequency storm. During the 10-year period, lesser storms will occur which will produce less runoff and will not inundate the entire street.

Planning and design for urban storm runoff must be considered from the viewpoint of both the regularly expected storm occurrence, that is, the design storm, and the major storm occurrence. The design storm will have a 10-year or 25-year return period depending on the street classification. The major storm will have a return period of 100 years. The objectives of the major storm runoff planning is to eliminate major damage and loss of life. The design drainage system is necessary to eliminate inconvenience, frequently recurring damage, and high street maintenance costs.

700.3.1 Street Capacity for Design Storm

Determination of street capacity for the design storm shall be based upon pavement encroachment. The pavement encroachment for the design storm shall be limited as set forth in the following paragraphs.

When the maximum encroachment is reached, a separate storm drainage system or additional storm drainage capacity shall be provided and designed on the basis of the design storm. Development of the major drainage system is encouraged so that the design storm runoff is removed from the streets, thus moving the point at which the storm drainage system must begin further downstream.

Calculating Capacity

In general, an arterial street crossing will require installation of a storm drain system or other suitable means to transport the design storm runoff under the arterial street. Residential collector streets shall have cross valley gutters only at infrequent locations, as specified in accordance with good engineering practices.

Lowering of the standard height of street crown shall not be allowed for the purposes of hydraulic design, unless approved by the City Engineer. In no case will reduced crowns be allowed on arterial streets.

Where additional hydraulic capacity is required on a street, the gradient must be increased and/or inlets and storm drains or other storm water conveyance facilities shall be installed to remove the required portion of the flow.

Alleys are not an integral part of the drainage system. In general, alleys, shall be designed to convey only the runoff from the rear of adjacent lots and direct it to the street at the end of the block. In no case shall runoff in any street be directed to flow into an alley or an alley be used as a drainage way.

When the allowable encroachment has been determined, the gutter (that portion of the street used to convey runoff) capacity shall be computed using the appropriate pavement section with the curb forming a vertical leg of the section. These gutter cross sections usually take the form of a triangular (straight crown slope), composite, or parabolic section. The designer should consider the design cross section and construction techniques when determining which section should be used for computing gutter flow capacity. The following sections describe procedures for computing gutter capacity for straight crown (triangular), composite, and parabolic street cross sections.

The flow of storm water in curb gutter sections is classified as open channel flow. Design calculations are based on a modified form of Manning's Equation. A modification to the hydraulic radius term is required because the hydraulic radius is not suitable for describing the street cross sections. In some cases, the width may be 50 times the depth.

Straight Crowns

The modified Manning's Equation is utilized in triangular channels for straight crown sections to better describe the hydraulic radius of a gutter section. The equation in terms of cross slope and curb is:

$$Q = 0.56 \left[\frac{Z}{N} \right] S^{1/2} d^{2.67} \quad (700-1)$$

where:

Q = discharge, in cubic feet per second, Figure 3-2
Z = reciprocal of cross slope, 1/S_x, in feet per foot

n = Manning's roughness coefficient
 S = longitudinal slope, in feet per foot (ft/ft)
 d = depth of flow at curb or deepest point, in feet

The resistance of the curb face is neglected in the equation since the resistance is negligible when the cross slope is 10 percent or less.

The width of flow or spread in a triangular channel can be calculated by the following equation.

$$T = Zd \quad (700-2)$$

where:

T = width of flow (spread), in feet
 Z = reciprocal of cross slope, $1/S_x$, in feet per foot
 d = depth of flow at curb or deepest point, in feet

Exhibit 700-1 can be used for a direct solution of Equation 700-1, using Manning's "n" value of 0.016. For other values of "n", divide the value of Q_n by "n". Manning's "n" values for different street and gutter roughness conditions are presented in Table 700-1.

TABLE 700-1 Manning's Roughness Coefficients for Streets and Gutters

Surface Type	"n" Value
Concrete gutter troweled finish	0.012
Asphalt pavement:	
Smooth texture	0.013
Rough texture	0.016
Concrete gutter with asphalt pavement:	
Smooth	0.013
Rough	0.015
Concrete pavement:	
Float finish	0.014
Broom finish	0.016
Brick	0.016

Example 1 - Straight Crown Section - Gutter Carrying Capacity for Design Storm

Given: 6-inch vertical curb
 35 ft wide, face to face of curb, residential collector street (36 ft Back of Curb to Back of Curb)
 straight crown section without crown offset
 6-inch crown height
 Street grade = 0.5% = 0.005 ft/ft
 assume $n = 0.016$

Find: Capacity, each gutter

- Solution:
- 1) Determine allowable pavement encroachment.
from Section 700.3.1, one standard lane (12 ft) must remain clear.
 - 2) Calculate width of flow, cross slope, and gutter flow depth for allowable encroachment.

$$T = \text{top width} = (35 \text{ ft} - 12 \text{ ft})/2 = 11.5 \text{ ft}$$

$$S_x = \text{cross slope} = 0.5 \text{ ft} / 17.5 \text{ ft} = 0.0286 \text{ ft/ft}$$

$$d = \text{gutter flow depth} = (11.5 \text{ ft} / 17.5 \text{ ft}) \times 0.5 = 0.328 \text{ ft} = 3.9 \text{ in.}$$

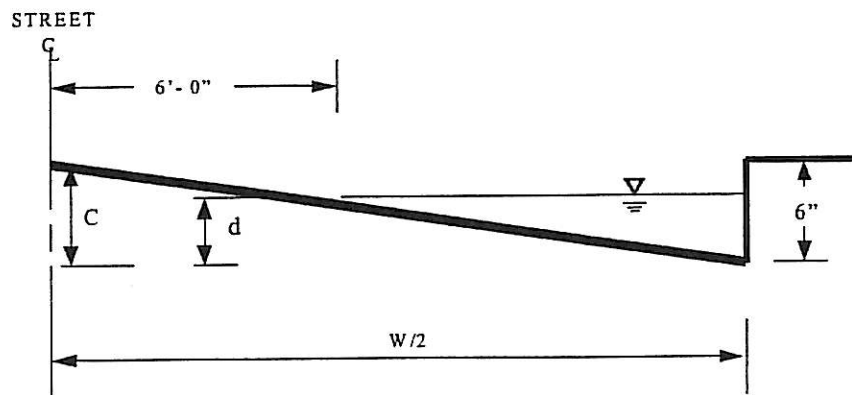

- 3) Calculate capacity for each gutter.
Using equation 700-1 (also Nomograph in Exhibit 700-1 may be used)

$$Q = 0.56 \left[\frac{Z}{n} \right] S^{0.5} d^{2.67} \quad 700-3$$

$$Z = 1 / S_x = 1 / 0.0286 = 35$$

$$Q = 0.56 \times (35 / 0.016) \times (0.005)^{0.5} \times (0.328)^{2.67}$$

$$Q = 4.4 \text{ cfs in each gutter}$$

Parabolic Crowns

Parabolic crowns are frequently used in street cross section design as a means of uniformly increasing the cross slope rate toward the gutter. Flat slopes are near the centerline of the roadway where a minimum accumulation of water occurs, and the steep slopes are in the gutter where storm water accumulates. Flows in the gutter of a

parabolically crowned street are calculated from a variation of Manning's Equation, as shown in Equation 700-4 below, which assumes steady flow in a prismatic open channel.

$$Q = \frac{1.486}{n} \cdot \left[\frac{4c}{w^2} \int_{x_a}^{x_b} x^2 dx - \left(\frac{4c}{w^2} x_a^2 \right) (x_b - x_a) \right] \cdot \left[\frac{\frac{4c}{w^2} \int_{x_a}^{x_b} x^2 dx - \left(\frac{4c}{w^2} x_a^2 \right) (x_b - x_a)}{\int_{x_a}^{x_b} \left(1 + \left(\frac{8c}{w^2} x^2 \right)^2 \right)^{\frac{1}{2}} dx + \frac{4c}{w^2} (x_b^2 - x_a^2)} \right]^{\frac{2}{3}} \cdot S^{\frac{1}{2}}$$

(700-4)

where:

- Q = gutter flow, cfs
- c = street crown, feet
- w = total street width from face of curb to face of curb, feet
- n = Manning's roughness coefficient
- S = street or gutter slope, ft/ft.
- x_a, x_b = horizontal coordinates, ft.

Equation 700-4 is complicated and difficult to solve. To provide a means of determining flow in the gutter, generalized gutter flow equations for combinations of parabolic crown heights, curb splits, and street grades of different street widths are provided. These equations have a logarithmic form and may be used to calculate gutter flow for parabolic streets with or without curb split.

Streets Without Curb Split

Curb split is the vertical difference in elevation between curbs at a given street cross section. The gutter flow equation for parabolic crown streets without any curb split is:

$$\text{Log } Q = K_0 + K_1 \text{Log } S + K_2 \text{Log } y \quad (700-5)$$

where

- Q = gutter flow, cfs
- S = street or gutter slope, ft/ft
- y = water depth in the gutter, feet
- K₀, K₁, K₂ = constant coefficients shown in Table 700-2 for different street widths.

Table 700-2 Gutter Flow Coefficients for Streets Without Curb Split, (Eqn. 700-5)

Street Width (feet)	Coefficients		
	K ₀	K ₁	K ₂
30	2.85	0.50	3.03
35	2.88	0.50	3.00
36	2.89	0.50	2.99
40	2.85	0.50	2.89
44	2.84	0.50	2.78
48	2.83	0.50	2.78
60	2.85	0.50	2.74

*Note: Street width in this table is measured from face of curb to face of curb (F-F). Source: County of Austin Drainage Manual

Streets With Curb Split - Higher Capacity Gutter

The gutter flow equation for calculating gutter flow in the gutter with the larger capacity is as follows:

$$\text{Log } Q = K_0 + K_1 \text{ Log } S + K_2 \text{ Log } y + K_3 (\text{CS}) \quad (700-6)$$

where:

- Q = gutter flow, cfs
- S = street or gutter slope, ft/ft
- y = water depth in the gutter, feet
- CS = curb split, feet
- K₀, K₁, K₂, K₃ = constant coefficients shown in Table 700-3 for different street widths.

Table 700-3 Gutter Flow Coefficients for Streets With Curb Split - Higher Gutter (Eqn. 700-5)

Street Width (feet)	Coefficients				Curb Split Range (feet)
	K ₀	K ₁	K ₂	K ₃	
30	2.85	0.50	3.03	-0.131	0.0-0.6
35	2.88	0.50	3.00	-0.139	0.0-0.8
36	2.89	0.50	2.99	-0.140	0.0-0.8
40	2.85	0.50	2.89	-0.084	0.0-0.8
44	2.84	0.50	2.78	-0.091	0.0-0.9
48	2.83	0.50	2.83	-0.095	0.0-1.0
60	2.85	0.50	2.74	-0.043	0.0-1.2

*Note: Street width in this table is measured from face of curb to face of curb (F-F). Source: County of Austin Drainage Manual

Streets With Curb Split - Lower Capacity Gutter

The gutter flow equation for calculating gutter flow in the gutter with the lesser capacity is as follows:

$$\text{Log } Q = K_0 + K_1 \text{ Log } S + K_2 \text{ Log } y + K_3 (\text{CS}) \quad (700-7)$$

where

- Q = gutter flow, cfs
 S = street or gutter slope, ft/ft
 y = water depth in the gutter, feet
 CS = curb split, feet
 K₀, K₁, K₂, K₃ = constant coefficients shown in Table 700-4 for different street widths.

Table 700-4 Gutter Flow Coefficients for Streets With Curb Split - Lower Gutter (Eqn. 700-7)

Street Width (feet)	K ₀	Coefficients			Curb Split Range (feet)
		K ₁	K ₂	K ₃	
30	2.70	0.50	2.74	-0.215	0.0-0.6
35	2.73	0.50	2.73	-0.214	0.0-0.8
36	2.74	0.50	2.73	-0.214	0.0-0.8
40	2.75	0.50	2.73	-0.198	0.0-0.8
44	2.76	0.50	2.73	-0.186	0.0-0.9
48	2.77	0.50	2.72	-0.175	0.0-1.0
60	2.80	0.50	2.71	-0.159	0.0-1.2

*Note: Street width in this table is measured from face of curb to face of curb (F-F). Source: County of Austin Drainage Manual

Parabolic Crown Location

The gutter flow equation presented for parabolic crowns with split curb heights is based on a procedure for locating the street crown. The procedure allows the street crown to shift from the street center line toward the high $\frac{1}{4}$ point of the street in direct proportion to the amount of curb split. The maximum curb split occurs with the crown at the $\frac{1}{4}$ point of the street. The maximum allowable curb split for a street with parabolic crowns is 0.02 feet per foot of street width.

Example: Determination of Crown Location

- Given: 0.4 feet design split on 30-ft wide street (measured face to face of curb)
 Maximum curb split = $0.02 \times \text{street width} = s \cdot w$
 = $0.02 \times 30 \text{ feet} = 0.6 \text{ feet}$
 Maximum movement = $\frac{1}{4} \times 30 \text{ feet} = 7.5 \text{ feet}$
 Split movement = $(\text{Design split} \times \text{Width} / \text{Maximum Split} \times 4)$

$$= 0.4 \times 30 / (0.6 \times 4) = 5 \text{ feet}$$

Special consideration should be given when working with cross sections which have the pavement crown above the top of curb. When the crown exceeds the height of the curb, the maximum depth of water is equal to the height of the curb, not the crown height. It should be noted that a parabolic section where the crown equals the top of curb will carry more water than a section which has the crown one (1) inch above the top of curb.

Example 2 - Parabolic Section - Gutter Carrying Capacity for Design Storm

Given: 6-inch vertical curb
 35 ft wide, face to face of curb, residential collector street (36 ft B-B)
 Parabolic section without curb split
 6-inch crown height
 Street grade = 0.5% = 0.005 ft/ft
 Assume $n = 0.016$

Find: Capacity, each gutter

- Solution:
- 1) Determine allowable pavement encroachment.
 From Section 700, one standard lane (12 ft) must remain clear.
 - 2) Calculate gutter flow depth for allowable encroachment.
 Allowable encroachment = $(35 \text{ ft} - 12 \text{ ft})/2 = 11.5 \text{ ft}$, $x = 12 \text{ ft}/2 = 6 \text{ ft}$

$$y = 0.5' - \frac{4(0.5')}{(3.5')^2} (6')^2 = 0.44' = 5.3'' - x$$

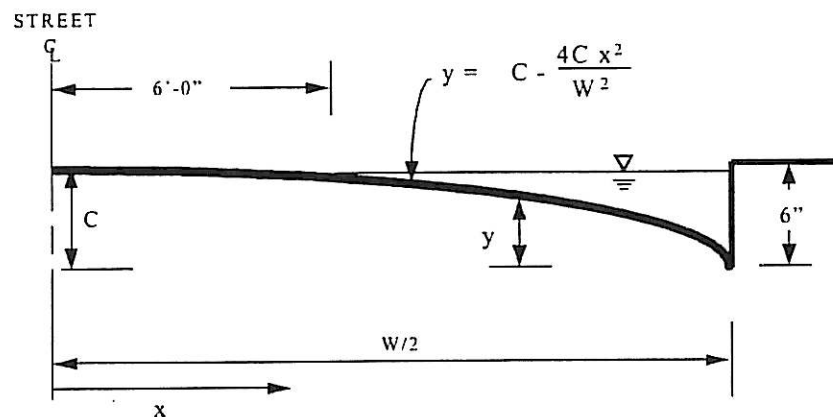

- 3) Calculate capacity for each gutter, Q
 Using equation 3-4,
 $\text{Log } Q = K_0 + K_1 \text{Log } S + K_2 \text{Log } y$
 from Table 3-2, $K_0 = 2.88$, $K_1 = 0.50$, $K_2 = 3.00$
 $\text{Log } Q = 2.88 + 0.50 \text{Log } (0.005) + 3.00 \text{Log } (0.44)$
 $\text{Log } Q = 2.88 - 1.15 - 1.07 = 0.66$
 $Q = 10^{0.66} = 4.6 \text{ cfs in each gutter}$

Note: Compare capacity of residential collector with parabolic section (Example 2) with straight crown section (Example 1). The parabolic section has a capacity of 4.6 cfs in each gutter while the straight crown has a capacity of 4.4 cfs.

700.3.2 Permissible Spread of Water

Principal Arterial Streets

Inlets shall be spaced at such an interval as to provide one clear traffic lane in each direction during the peak flows of the design storm.

Use of depressed inlets adjacent to a traffic lane is discouraged. If used however, gutter depressions may not exceed 3 inches and taper a sufficient length along the roadway profile (minimum 10') unless specifically approved by the City Engineer. The design storm will have a 10-year return frequency.

Example: Street width 60 feet; two 12-foot lanes to remain clear.

Therefore: Street flow in each gutter shall not exceed $(60 - 24) / 2 = 18$ feet.

Minor Arterial and Collector Streets

The flow of water in gutters of the minor arterial streets shall be limited so that one standard lane will remain clear during the peak runoff from the design storm. Inlets shall be located at low points or wherever the flow exceeds the one standard lane requirement. Gutter depression at the inlets is discouraged, but shall not exceed 3 inches in any case. The design storm will have a 10-year return frequency.

Example: Street width 49 ft.; one 12-foot traffic lane to remain clear.

Therefore: Street flow in each gutter shall not exceed $(49 - 12) / 2 = 18.5$ ft.

Residential Collector Streets

The flow of water in gutters of a residential collector street shall be limited so that one standard lane will remain clear during the peak runoff from the design storm. Inlets shall be located at low points or wherever the flow exceeds the one standard lane requirement. Gutter depression at the inlet is discouraged, but shall not exceed 3 inches in any case. The design storm will have a 10-year return frequency.

Example: Street width – 36 ft.; one 12-foot traffic lane to remain clear.

Therefore: Street flow in each gutter shall not exceed $(36 - 12) / 2 = 12$ ft.

Residential Streets

The flow of water in gutters of a residential street shall be limited to a depth of flow at the curb of 6 inches or wherever the street is just covered, whichever is the least depth. Inlets shall be located at low points, or wherever the gutter flow exceeds the permissible spread of water.

In no case shall the gutter depression at the inlet exceed 3 inches. The design storm will have a 10-year return frequency.

700.3.3 Bypass Flows

Flow bypassing each inlet must be included in the total gutter flow to the next inlet downstream. A bypass of 10 to 20 percent per inlet will result in a more economical drainage system. Refer to Section 800 for inlet design.

700.3.4 Minimum and Maximum Flows

To ensure cleaning velocities at very low flows, the gutter shall have a minimum slope of 0.005 feet per foot (0.5%) with 1.00% desirable. The maximum velocity of curb flow shall be 10 feet per second. Along sharp horizontal curves, peak flows tend to jump behind the curb line at driveways and other curb breaks. Water running behind the curb line can result in considerable damage due to erosion and flooding. In a gutter where the slope is greater than 0.10 feet per foot (10%) and the radius is 400 feet or less, design depth of flow shall not exceed 4 inches at the curb.

700.3.5 Curb and Gutter

Normally the City of Bryant requires curb and gutter along city streets. In the event a developer proposes to utilize shoulders and open drainage ditches the City Engineer may at his discretion waive the requirement for a curb and gutter.

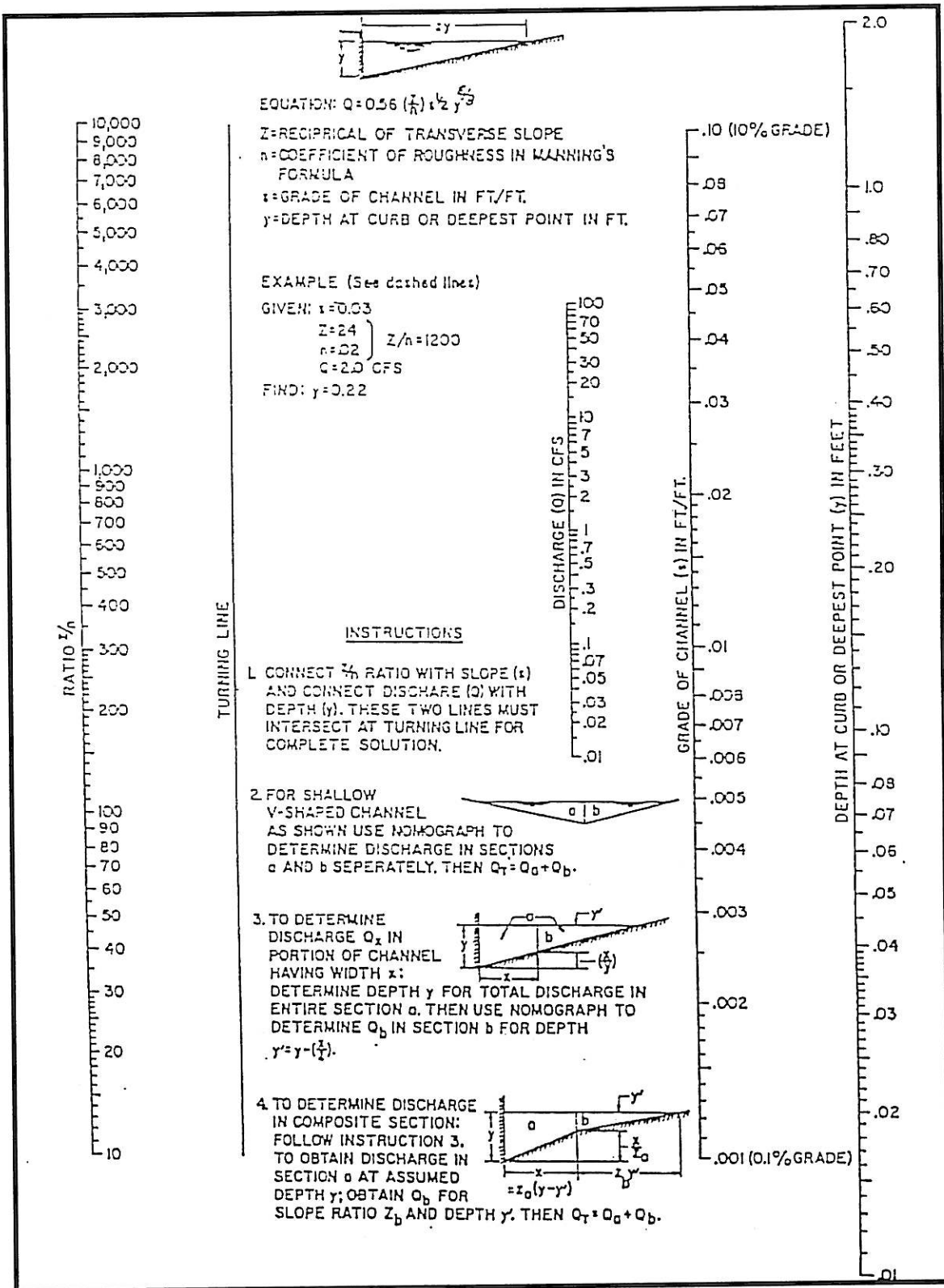

Exhibit 700-1
Nomograph for Flow in Triangular Channels
 Source: (City of Little Rock Stormwater Drainage Manual)

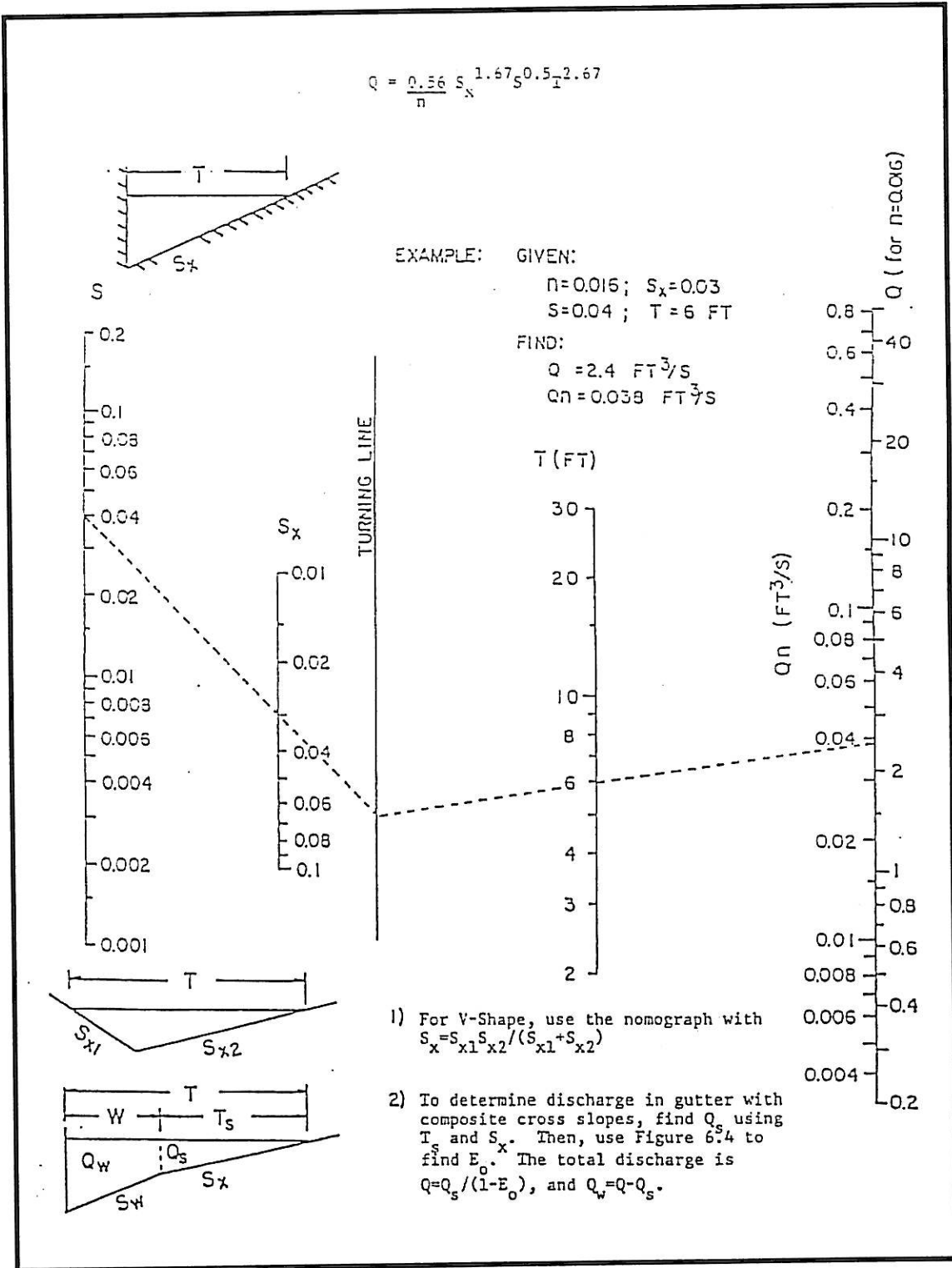

Exhibit 700-2
Flow in Triangular Gutter Sections

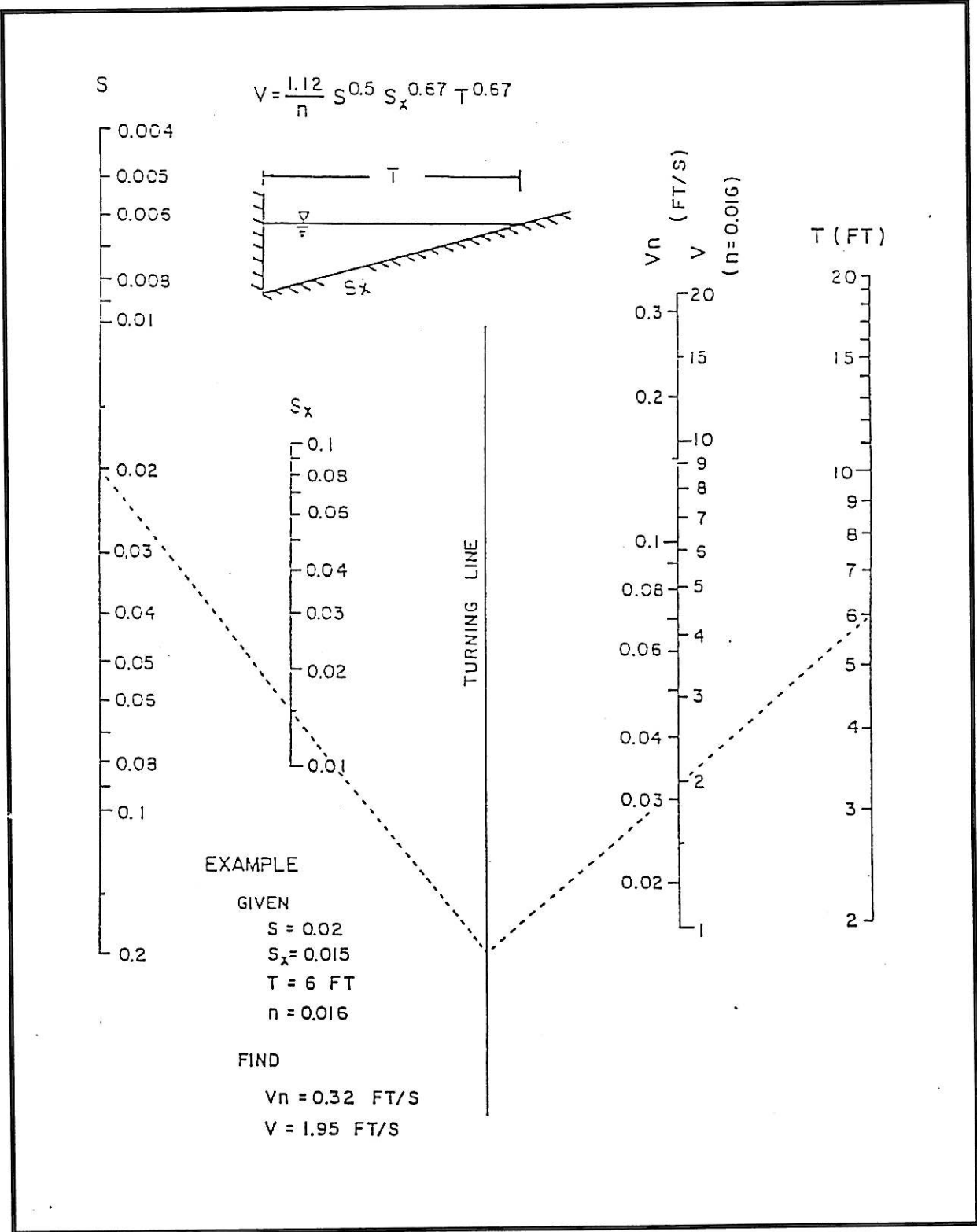

Exhibit 700-3
Velocity in Triangular Gutter Sections

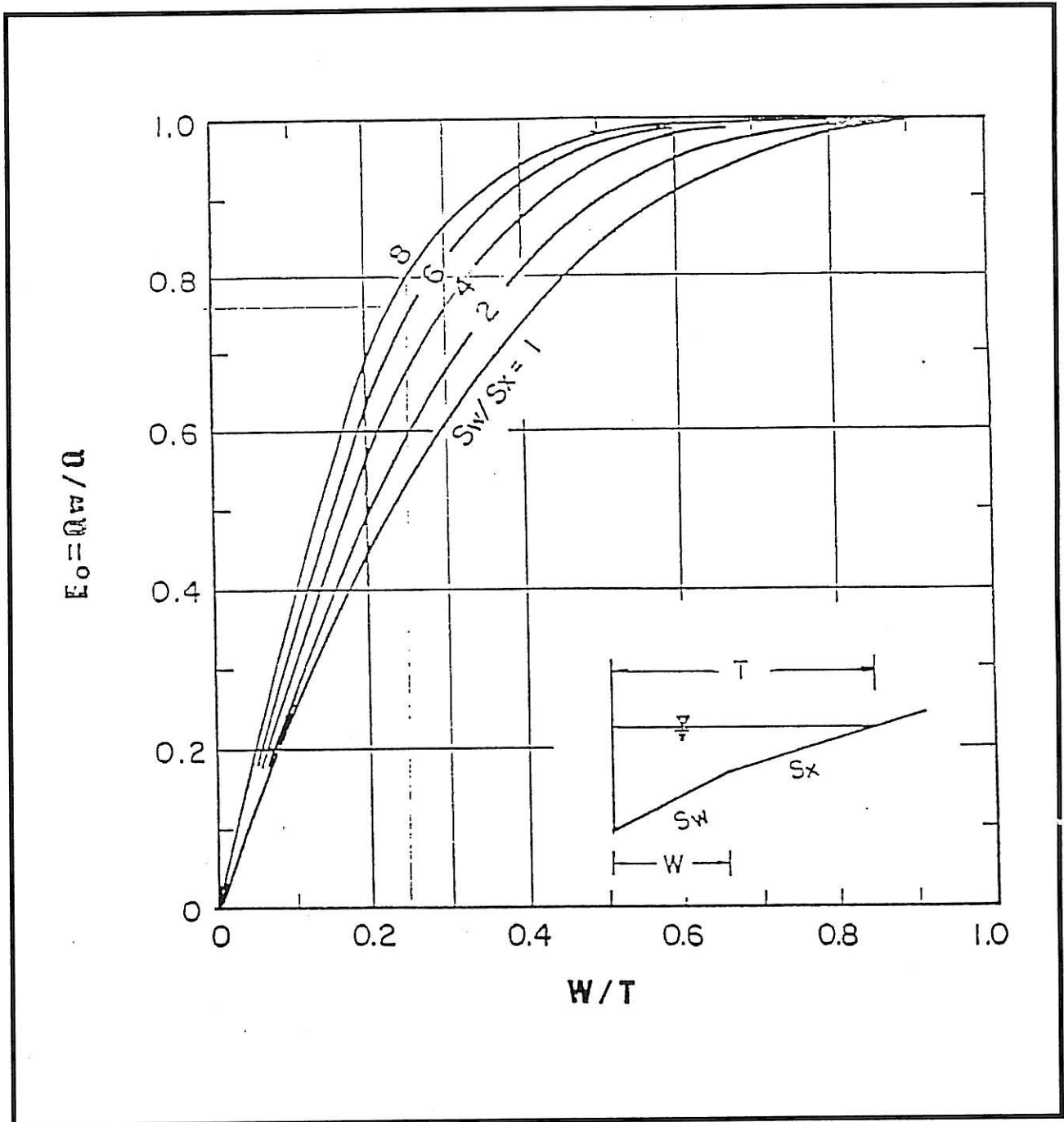

Exhibit 700-4
Ratio of Flow to Total Gutter Flow

**SECTION 800
STORM INLETS**

	<u>Page</u>
800.1 GENERAL	171
800.2 CLASSIFICATION	171-172
800.3 INLETS IN SUMPS	172-173
800.4 INLETS ON GRADE WITHOUT GUTTER DEPRESSION	173-174
800.5 INLETS ON GRADE WITH GUTTER DEPRESSIONS	175-176
800.6 USE OF EXHIBITS 800-1 AND 800-12	176-178
EXHIBITS	179-190

SECTION 800 STORM INLETS

800.1 GENERAL

The primary purpose of storm drain inlets is to intercept excess surface runoff and deposit it in a drainage system, thereby reducing the possibility of surface flooding.

The most common location for inlets is in streets which collect and channelize surface flow making it convenient to intercept. Because the primary purpose of streets is to carry vehicular traffic, inlets must be designed so as not to conflict with that purpose.

The following guidelines shall be used in the design of inlets to be located in streets:

1. Minimum transition for depressed inlets shall be 10 feet.
2. The use of inlets with a depression is discouraged on collector, industrial and arterial streets unless the inlet depression is recessed a minimum of 2' behind the curb.
3. When recessed inlets are used, they shall not interfere with the intended use of the sidewalk.
4. The capacity of a recessed inlet on grade shall be calculated the same as the capacity of a similar un-recessed inlet.
5. Design and location of inlets shall take into consideration pedestrian and bicycle traffic.
6. Inlet design and location must be compatible with the criteria established in other sections of this manual.
7. Inlet throat lengths shall be in 4' increments.
8. Any ring and cover, grate or other casting that is located within the driving surface shall be heavy duty, capable of supporting H-20 loading and bicycle safe.

800.2 CLASSIFICATION

Inlets are classified into three major groups, mainly: Inlets in sumps (Type A), inlets on grade without gutter depression (Type B), and inlets on grade with gutter depression (Type C). Each of the three major classes include several varieties. The following are presented herein and are likely to find reasonable wide use. (See Exhibits 800-1 – 800-7)

Inlets in Sumps

- | | | |
|----|------------------------------------|----------|
| 1. | Curb opening | Type A-1 |
| 2. | Grate | Type A-2 |
| 3. | Combination (grate & curb opening) | Type A-3 |
| 4. | Drop | Type A-4 |
| 5. | Drop (grate covering) | Type A-5 |

Inlets on Grade Without Gutter Depression

- | | | |
|----|------------------------------------|----------|
| 1. | Curb Opening | Type B-1 |
| 2. | Grate | Type B-2 |
| 3. | Combination (grate & curb opening) | Type B-3 |

Inlets on Grade with Gutter Depression

- | | | |
|----|------------------------------------|----------|
| 1. | Curb Opening | Type C-1 |
| 2. | Grate | Type C-2 |
| 3. | Combination (grate & curb opening) | Type C-3 |

Recessed inlets are identified by the suffix R, (i.e.: A-1 (R)).

The City of Bryant Public Works Department's review of the proposed Drainage Plan shall include examination of the supporting calculations. Computations must be submitted either as a part of the Plans or on separate tabulation sheets convenient for review and use as a permanent record.

800.3 INLET IN SUMPS

Inlets in sumps are inlets placed at low points of surface drainage areas to relieve ponding. Inlets with depressions located in streets of less than one percent (1.0%) grade, shall be considered inlets in sumps. The capacity of inlets in sumps must be known in order to determine the depth and width of ponding for a given discharge. The charts in this section may be used in the design of any inlet in a sump, regardless of its depth of depression.

800.3.1 Curb Opening Inlets and Drop Inlets

Unsubmerged curb opening inlets (Type A-1) and drop inlets (Type A-4) in a sump at low points are considered to function as rectangular weirs with a coefficient of discharge of 3.0. Their capacity shall be based on the following equation:

$$Q = 3.0 Y^{3/2} L$$

Q = capacity in CFS of curb opening inlet or capacity in CFS of drop inlet

Y = head at the inlet in feet when Y is less than the height of the opening

L = length of opening through which water enters the inlet in feet

Exhibit 800-8 provides for direct solution of the above equation. Curb opening inlets and drop inlets in sumps have a tendency to collect debris at their entrances. For this reason, the calculated inlet capacity shall be reduced by 20 percent to allow for clogging.

800.3.2 Grate Inlets

General. A grate inlet, Type A-2 or A-5 in a sump can be considered an orifice with the coefficient of discharge of 0.67. The capacity shall be based on the following:

$$Q = 5.37 A_g Y^{1/2}$$

Q = Capacity in CFS

A_g = area of clear opening in square feet

Y = depth at inlet or head at sump in feet when Y is less than height of opening

The curve shown in Exhibit 800-9 provides for direct solution of the above equation.

Grate inlets in sumps have a tendency to clog when flows carry debris such as leaves and papers. For this reason, the calculated inlet capacity of a grate inlet shall be reduced by 50 percent to allow for clogging.

800.3.3 Combination Inlets (Type A-3)

The capacity of a combined inlet Type A-3 consisting of a grate and curb opening inlet in a sump shall be considered to be the sum of the capacities obtained from Exhibits 800-8 and 800-9. When the capacity of the gutter is not exceeded, the grate inlet accepts the major portion of the flow. Under severe flooding conditions, however, the curb inlet will accept most of the flow since its capacity varies with $y^{1.5}$ whereas the capacity of the grate varies as $y^{0.5}$.

Combination inlets in sumps have a tendency to clog and collect debris at their entrance for this reason, the calculated inlet capacity shall be reduced by 30 percent to allow for this clogging.

800.4 INLETS ON GRADE WITHOUT GUTTER DEPRESSION

800.4.1 Curb Opening Inlets (Undepressed: Type B-1)

The capacity of the curb inlet, like any weir, depends upon the head and length of the overfall. In the case of an undepressed curb opening inlet, the head at the upstream end of the opening is the depth of flow in the gutter. In streets where grades are greater than 1 percent, the velocities are high and the depths of flow are usually small, as there is little time to develop cross flow into the curb openings. Therefore, undepressed inlets are inefficient when used in streets of appreciable slope, but may be used satisfactorily where

the grade is low and the crown slope high or the gutter channelized. Undepressed inlets do not interfere with traffic and usually are not susceptible to clogging. Inlets on grade should be designed and spaced so that 20 to 40 percent of gutter flow reaching each inlet will carry over to the next inlet downstream, provided the water carry-over does not inconvenience pedestrian or vehicular traffic.

The capacity of any undepressed inlet shall be determined by use of Exhibits 800-10 and 800-11.

800.4.2 Grate Inlets on Grade (Undepressed: Type B-2)

Undepressed grate inlets on grade have a greater hydraulic capacity than curb inlets of the same length so long as they remain unclogged. Undepressed inlets on grade are inefficient in comparison to grate inlets in sumps. For flow capacity through grate inlets, the engineer should refer to Federal Highway publication H.E.C. 12 or refer to the appropriate vendor catalog. Grate inlets should be designed and spaced so that 20 to 40 percent of the gutter flow reaching each inlet will carry over to the next downstream inlet, provided the carry-over does not inconvenience pedestrian or vehicular traffic.

Grates shall be certified by the manufacturer as bicycle-safe. For flows on streets with grades less than 1 percent, little or no splashing occurs regardless of the direction of the bars.

Vane grate inlets are the recommended grates for best hydraulic capacity and should be the first grate type considered on any project. The calculated capacity for a grate inlet shall be reduced by 25 percent to allow for clogging.

800.4.3 Combination Inlets on Grade (Undepressed: Type B-3)

The interception capacity of a combination inlet consisting of a curb opening and grate placed side-by-side, is not appreciably greater than that of the grate alone. Capacity is computed by neglecting the curb opening. A combination inlet is sometimes used with the curb opening or a part of the curb opening placed upstream of the grate. The curb opening in such an installation intercepts debris which might otherwise clog the grate. A combination inlet with a curb opening upstream of the grate has an interception capacity equal to the sum of the two inlets, except that the frontal flow and the interception capacity of the grate is reduced by the interception of the curb opening.

The capacity of a Type B-3 inlet without extensions shall be considered the same as the capacity of a type B-2 inlet (allowing reduction due to clogging).

800.5 INLETS ON GRADE WITH GUTTER DEPRESSIONS

800.5.1 Curb Opening Inlets on Grade (Depressed: Type C-1)

The depression of the gutter at a curb opening inlet below the normal level of the gutter increases the cross-flow toward the opening, thereby increasing the inlet capacity. Also, the downstream transition out of the depression causes backwater which further increases the amount of water captured. Depressed inlets should be used on continuous grades that exceed one percent (1%) except that their use in traffic lanes shall conform with the requirements of Section 700 of this manual.

The depression depth, width, length, and shape all have significant effects on the capacity of an inlet. Reference to Section 700 of this manual must be made for permissible gutter depressions.

The capacity of a depressed curb inlet will be determined by the use of Exhibits 800-10 and 800-11.

800.5.2 Grate Inlets on Grade (Depressed: Type C-2)

The depression of the gutter at a grate inlet decreases the flow past the outside of a grate. The effect is the same as that when a curb inlet is depressed, mainly the cross slope of the street directs the outer portion of flow towards the grate.

The bar arrangements for depressed grate inlets on streets with grades greater than 1 percent greatly affect the efficiency of the inlet. Grates with longitudinal bars eliminate splash which causes the water to jump and ride over the cross bar grates, and it is recommended that grates have a minimum of transverse cross bars for strength and spacing only.

For low flows or for streets with grades less than 1 percent, little or no splashing occurs regardless of the direction of the bars. However, as the flow or street grade increases, the grate with longitudinal bars becomes progressively superior to the cross bar grate. A few small rounded cross bars, installed at the bottom of the longitudinal bars as stiffeners or a safety stop for bicycle wheels do not materially affect the hydraulic capacity of the longitudinal bar grates. A bicycle safe grate must be used.

The capacity of a Type C-2 inlet on grades less than 1 percent shall be the capacity determined from Exhibit 800-9. The capacity of Type C-2 inlets on grades greater than 1 percent shall be 90 percent of the capacity as determined from Exhibit 800-9.

Grate inlets and depressions have a tendency to clog when gutter flow carry debris such as leaves and papers. For this reason, the calculated inlet capacity of a grate inlet shall be reduced by 25 percent to allow for clogging.

800.5.3 Combination Inlets on Grade (Depressed: Type C-3)

The interception capacity of a combination inlet consisting of a curb opening and grate placed side-by-side, is not appreciably greater than that of the grate alone. Capacity is computed by neglecting the curb opening. A combination inlet is sometimes used with the curb opening or a part of the curb opening placed upstream of the grate. The curb opening in such an installation intercepts debris which might otherwise clog the grate. A combination inlet with a curb opening upstream of the grate has an interception capacity equal to the sum of the two inlets, except that the frontal flow and thus the interception capacity of the grate is reduced by interception by the curb opening.

The capacity of a Type C-3 inlet without extensions shall be considered the same as the capacity of a Type C-2 inlet. (allowing reduction due to clogging).

800.6 USE OF Exhibits 800-10 AND 800-11Example 1

Given: $S_x = 0.03$ ft/ft
 $S = 0.035$ ft/ft

$Q = 5$ ft.³/S
 $n = 0.016$

Find: (1) Q_i for a 10-ft. curb-opening inlet
 (2) Q_i for a depressed 10-ft. curb opening inlet
 $a = 2$ in.
 $W = 2$ ft.

Solution: (1) $T = 8$ ft. (Exhibit 700-2)
 $L_T = 41$ ft. (Exhibit 800-10)
 $L/L_T = 10/41 = 0.24$
 $E = 0.39$ (Exhibit 700-11)
 $Q_i = EQ = 0.39 \times 5 = 2.0$ ft.³/S

(2) $T = 7.0$ ft. (Exhibit 700-2)
 $W/T = 2/7 = 0.29$
 $E_o = 0.72$ (Exhibit 700-4)
 $S_e = S_x + S_w E_o = 0.03 + 0.083 (0.72) = 0.09$

$L_T = 23$ ft. (Exhibit 800-10)
 $L/L_T = 10/23 = 0.43$
 $E = 0.64$ (Exhibit 800-11)
 $Q_i = 0.064 \times 5 = 3.2$ ft.³/S

RUNOFF AND INLET COMPUTATIONS

- Column 1: Inlet number. All inlets are classified with a designated number.
- Column 2: Inlet location. Location or station of inlet.
- Column 3: A – Drainage area in acres contributing runoff to the inlet.
- Column 4: C – Average or composite runoff coefficient of the area, A, contributing runoff to the inlet.
- Column 5: T_c – Time of concentration for the drainage area in minutes. See Section 400.
- Column 6: I – Rainfall intensity in inches per hour for the design storm. Based on the time of concentration. See Exhibit 400-4.
- Column 7: CA for the drainage area. Equal to Column 3 multiplied by Column 4.
- Column 8: Carry over, CA, from preceding inlet (Column 27).
- Column 9: Q_t – Total flow at the inlet. Equal to the sum of the values in Column 7 and Column 8 multiplied by the value in Column 6 or

$$Q_t = i * \Sigma CA$$

- Column 10: n – Manning's roughness coefficient for the gutter section.
- Column 11: S – The slope of the gutter profile in feet per foot.
- Column 12: S_x – Cross slope of the roadway section at the inlet in feet per foot. Not applicable for parabolic street sections.
- Column 13: T – Pondered width of flow in the street/gutter in feet. Obtained from Exhibit 700-2.
- Column 14: d – Depth of flow in the gutter section of the inlet in feet. Obtained from Exhibit 700-1 or

$$d = T * S_x$$

- Column 15: V – Velocity of flow in gutter in feet per second. Equal to Column 8 divided by one half of Column 12 multiplied by Column 13 or

$$V = Q/A$$

- Column 16: L – Length of the inlet in feet.
- Column 17: a – Depth of the gutter depression at the inlet in inches.
- Column 18: W – Width of the gutter depression at inlet in feet.
- Column 19: E_o – Ratio of frontal flow to total flow. Obtained from Exhibit 700-4 or
- $$E_o = Q_w/Q - 1 - (1 - W/T)^{2.67}$$
- Column 20: S_c – Equivalent cross slope of the pavement at the inlet in feet per foot:
- $$S_c = S_x + (a/12w) * \frac{E_o}{E}$$
- Column 21: L_t – Required length of inlet in feet for total flow interception. Obtained from Exhibit 800-10.
- Column 22: E – Efficiency of the inlet of length L. Obtained from Exhibit 800-11.
- Column 23: Q_i – Flow intercepted by the inlet of length L in CFS. Equal to Column 22 multiplied by Column 9 or
- $$Q_i = Q_t * E$$
- Column 24: RF – Clogging reduction factor for the inlet,
- Column 25: Q_a – Actual flow intercepted by the inlet in CFS. Equal to Column 23 multiplied by Column 24 or
- $$Q_a = Q_i * RF$$
- Column 26: Q_p – Bypass flow in CFS. Equal to Column 25 subtracted from Column 9 or
- $$Q_p = Q_t - Q_a$$
- Column 27: Carry over, CA, for the next downstream inlet. Equal to Column 26 divided by Column 6 or
- $$\text{Carry over} = Q_p / i$$

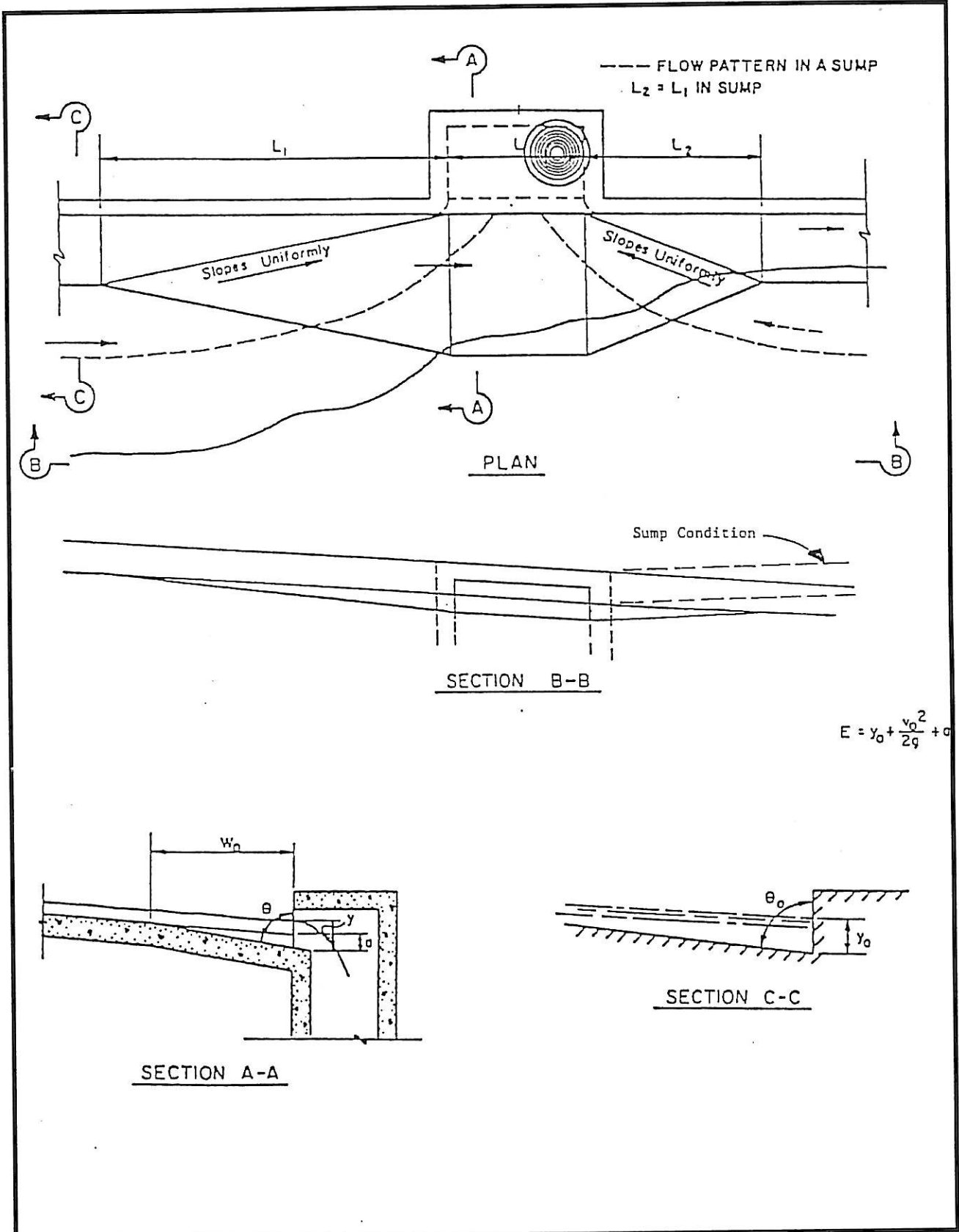

Exhibit 800-1
Depressed Curb Opening Inlet (Type A-1 and Type C-1)
 Source: (City of Little Rock Stormwater Drainage Manual)

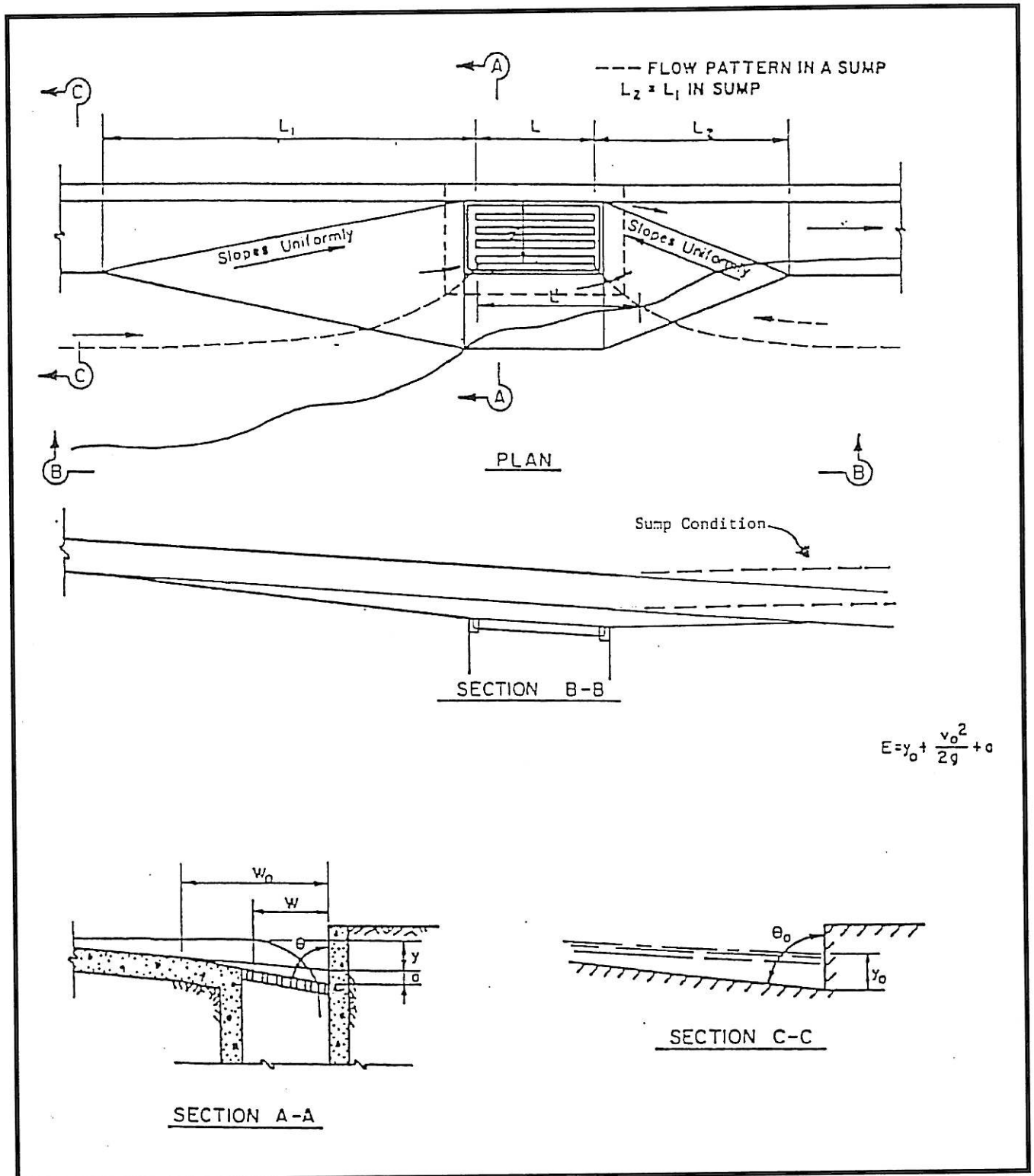

Exhibit 800-2
Depressed Grate Inlet (Type A-2 and Type C-2)
 Source: (City of Little Rock Stormwater Drainage Manual)

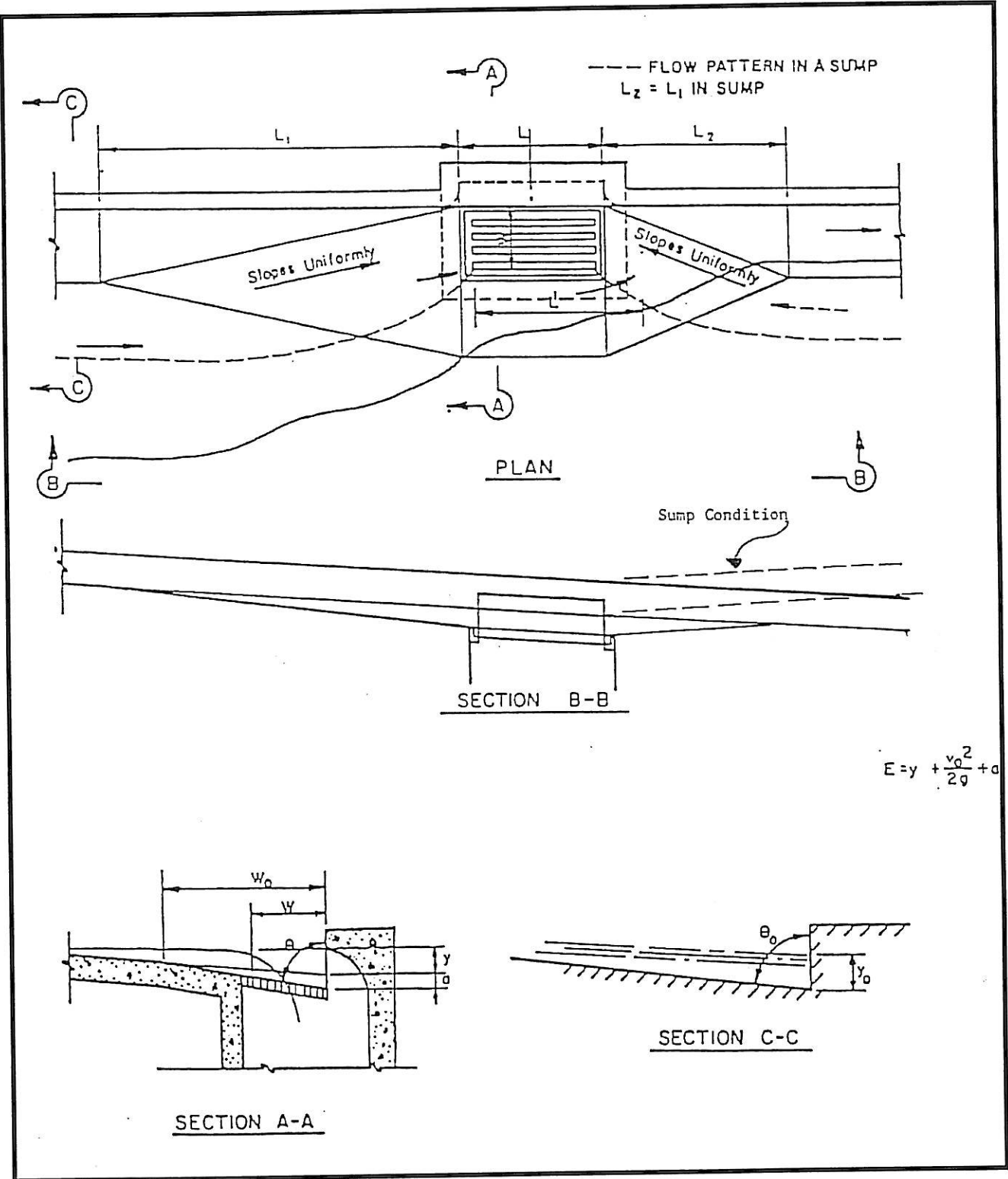

Exhibit 800-3
Depressed Combination Inlet (Type A-3 & Type C-3)
Source: (City of Little Rock Stormwater Drainage Manual)

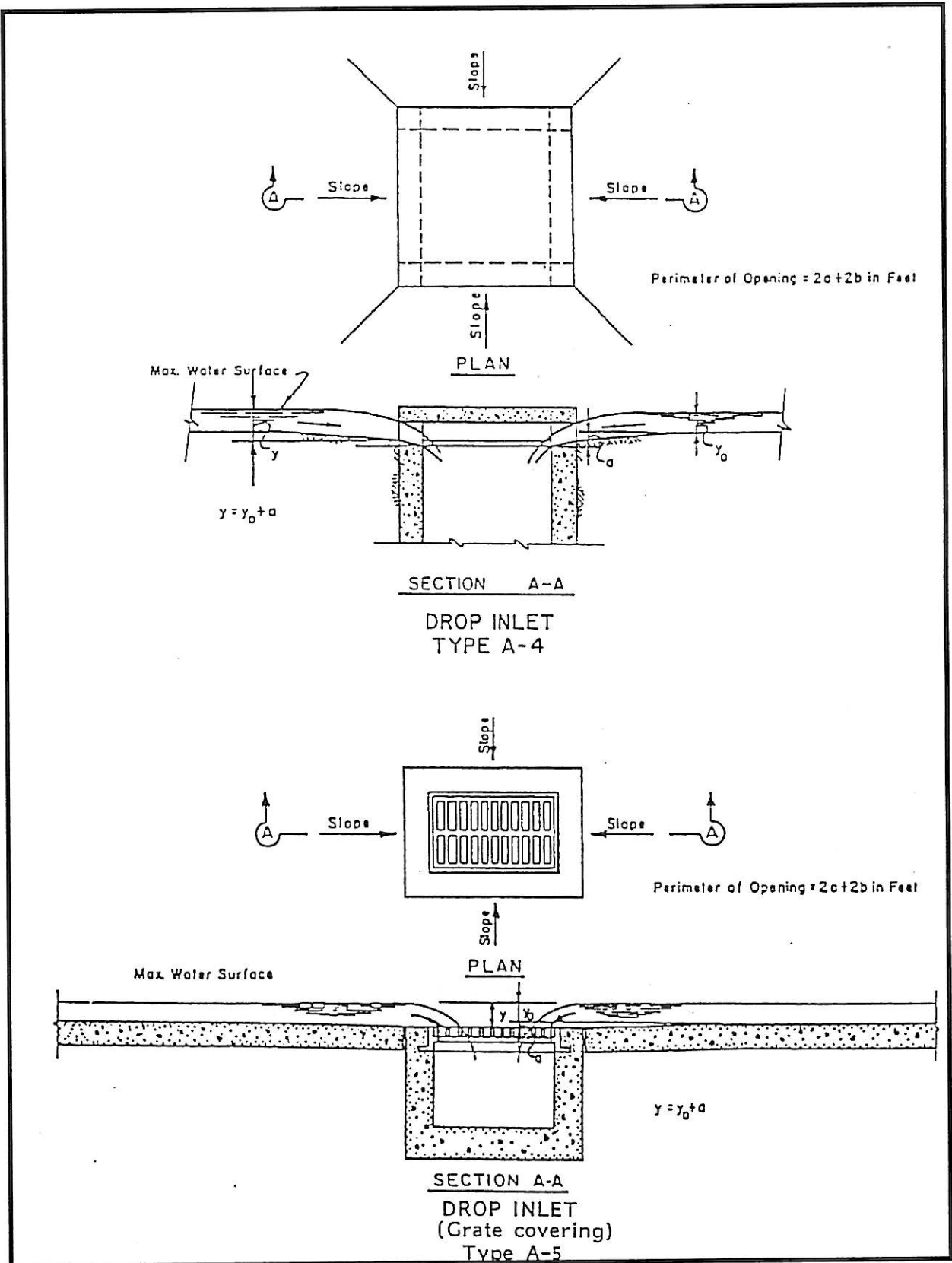

Exhibit 800-4

Drop Inlet
Type A-4

Drop Inlet
Type A-5

Source: (City of Little Rock Stormwater Drainage Manual)

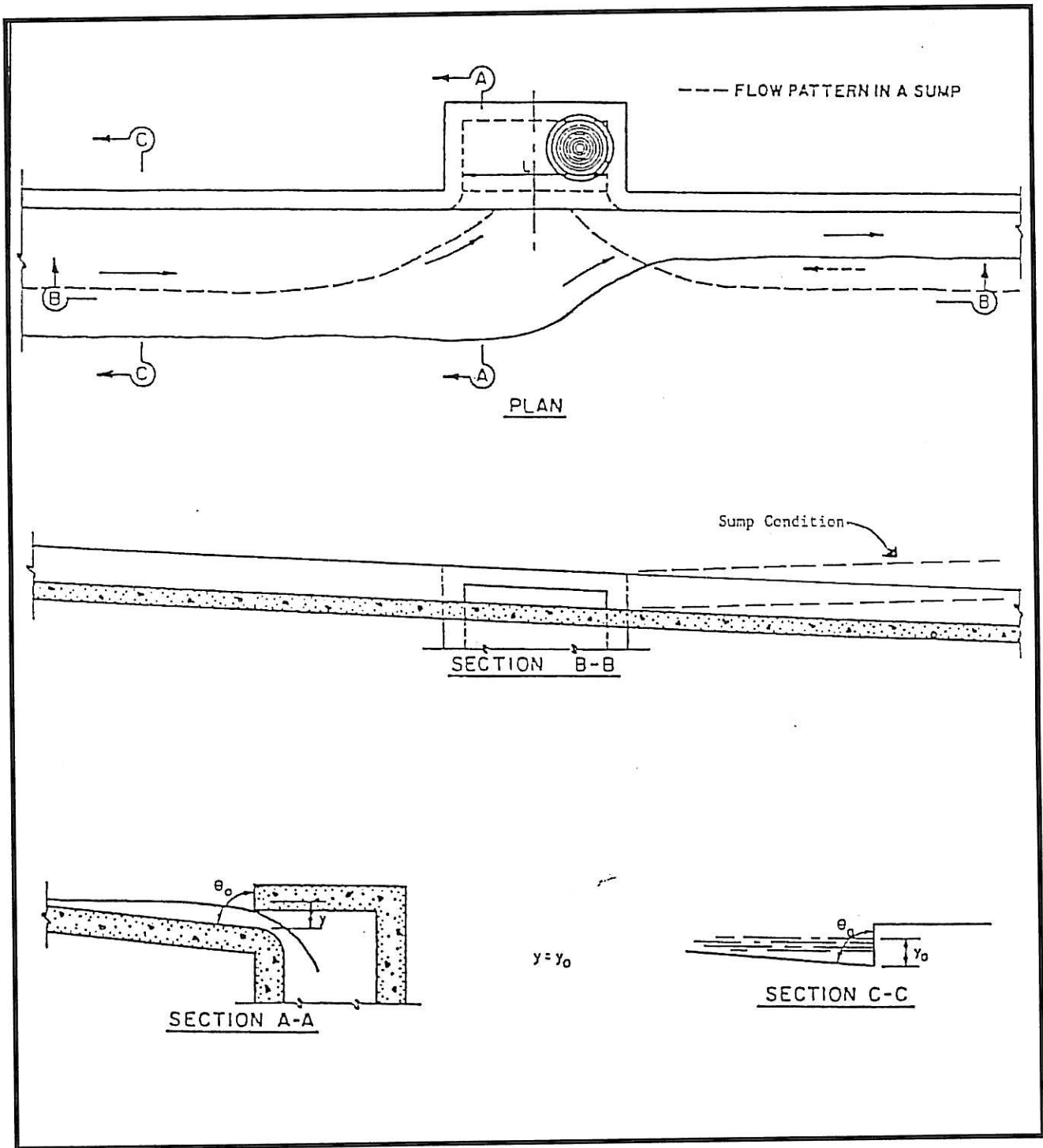

Exhibit 800-5
Undepressed Curb Opening
Inlet Type A-1 & B-1 (Recessed)
Source: (City of Little Rock Stormwater Drainage Manual)

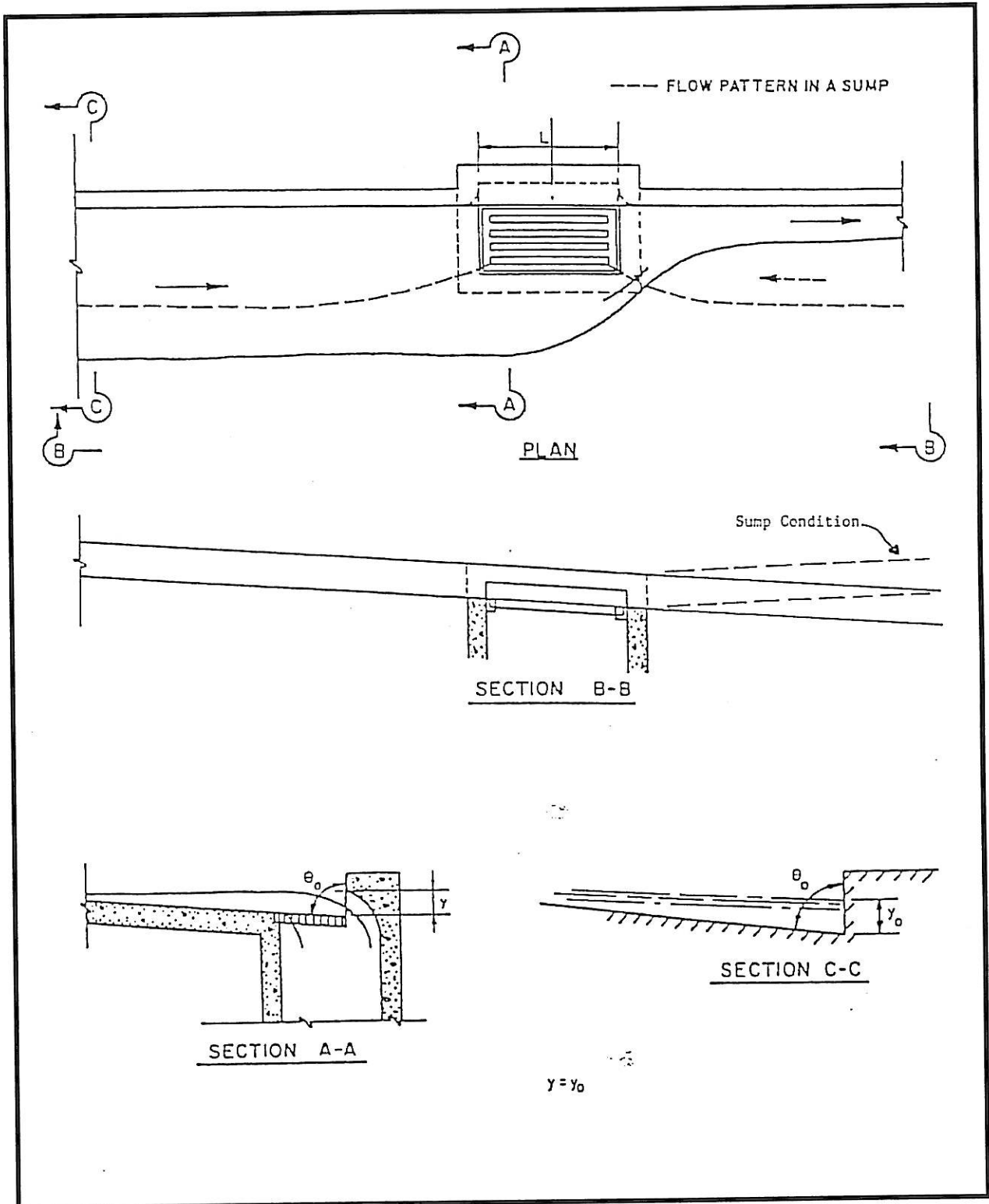

Exhibit 800-6
Undepressed Curb Opening
Inlet Type A-2 & B-2
Source: (City of Little Rock Stormwater Drainage Manual)

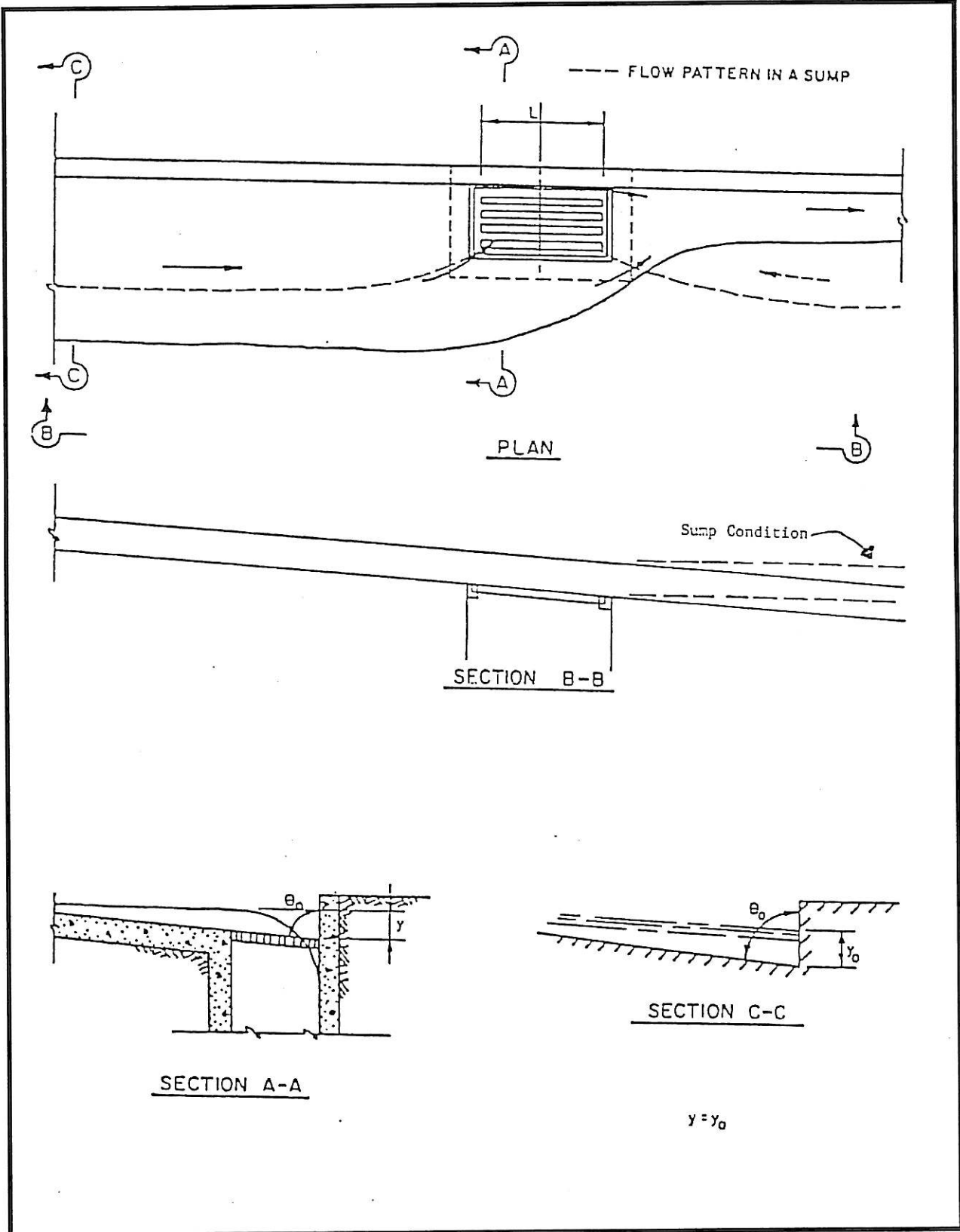

Exhibit 800-7
Undepressed Combination Inlet Type A-3 & B-3 (Recessed)
Source: (City of Little Rock Stormwater Drainage Manual)

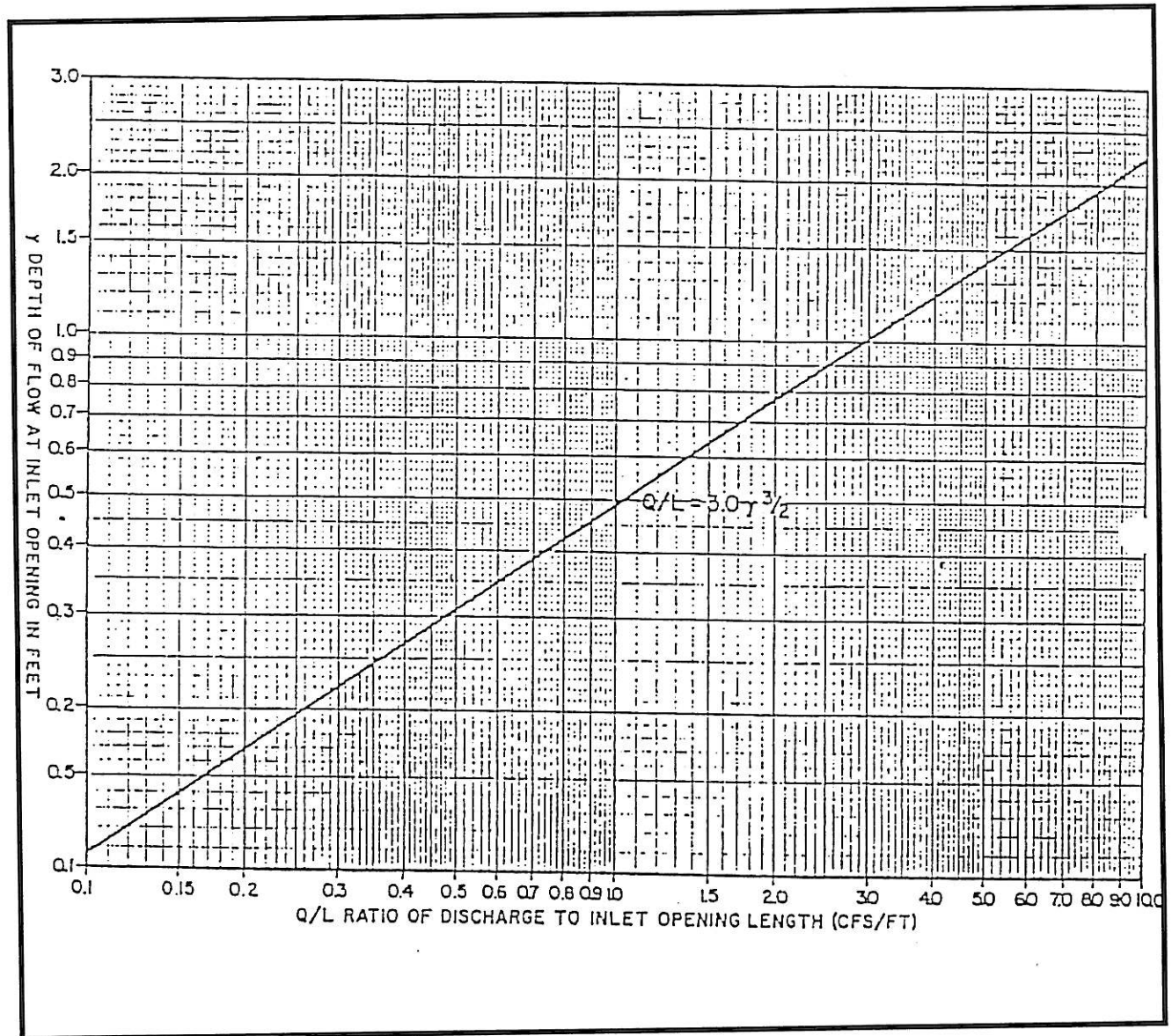
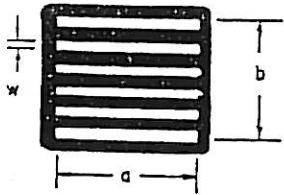
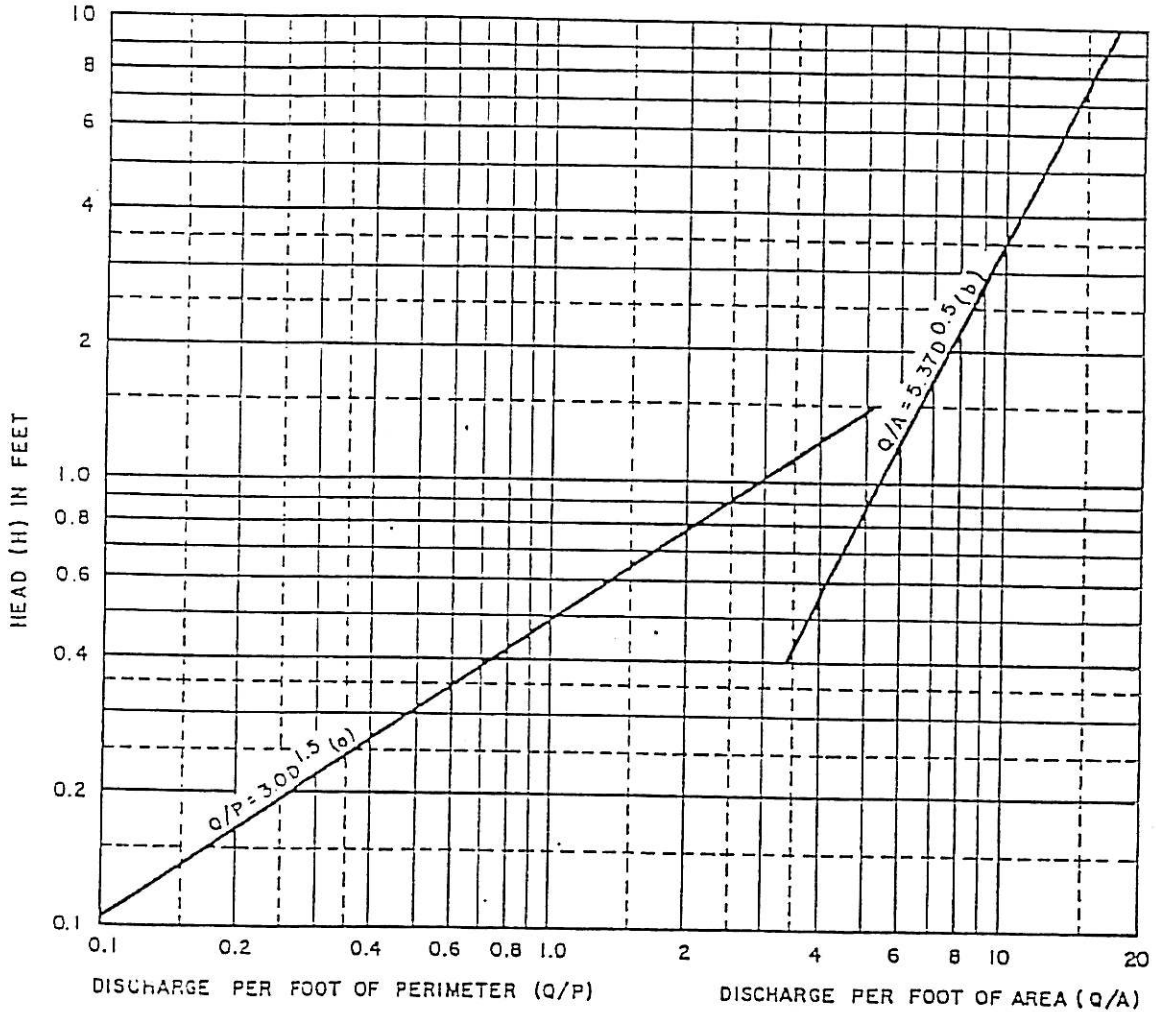

Exhibit 800-8
Inlet Capacity (Type A-1 & A-4)
Source: (City of Little Rock Stormwater Drainage Manual)



$P = 2(a + b)$
 $A = 6aw$

HEADS UP TO 0.4, CURVE (a) APPLIES
 HEADS ABOVE 1.4, CURVE (b) APPLIES
 HEADS BETWEEN 0.4 & 1.4, TRANSITION
 SECTOR, USE LESSOR VALUE OF DISCHARGE

CAPACITY OF GRATE INLET
 IN SAG

Exhibit 800-9
 Inlet Capacity Type A-2 & A-5

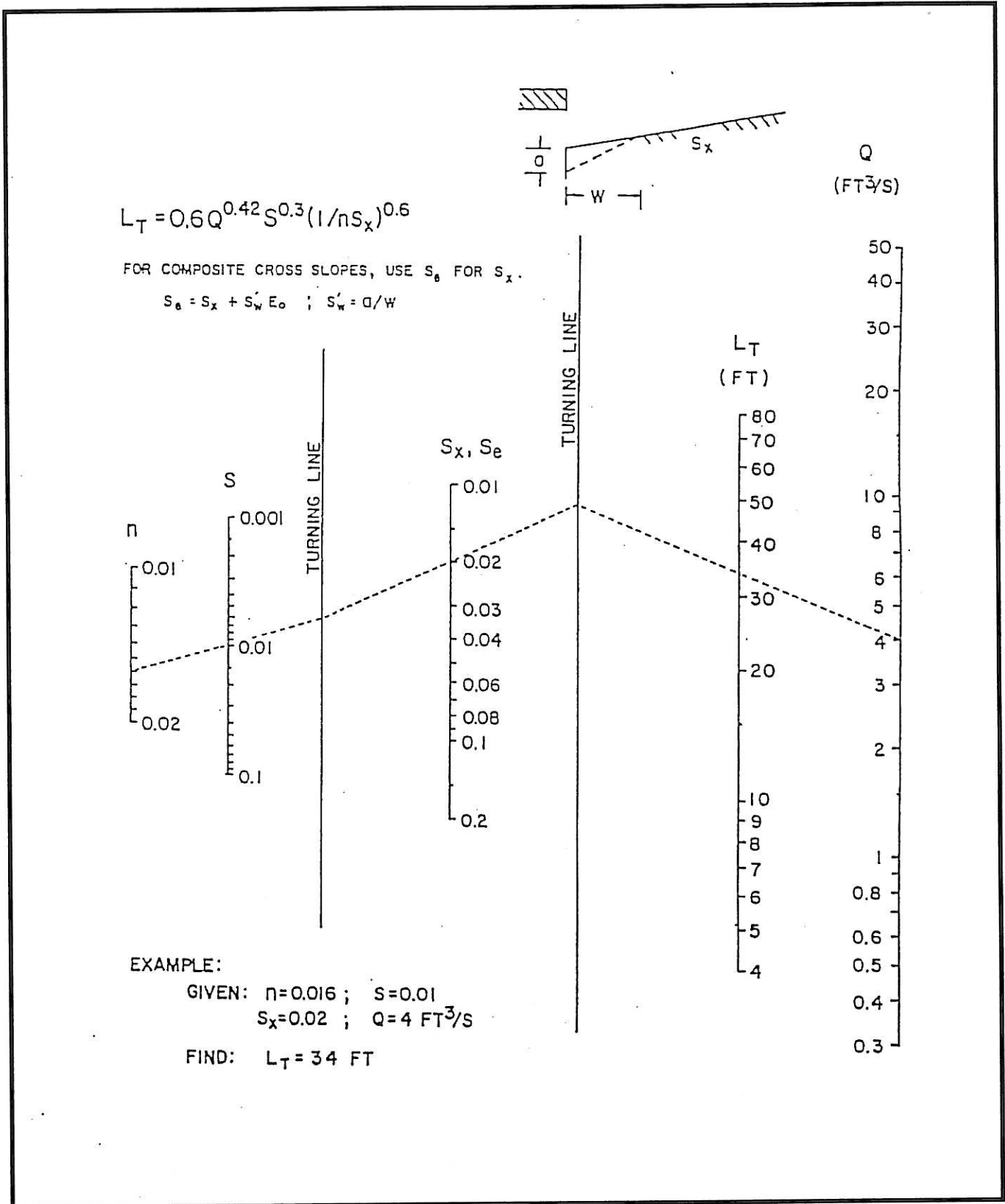

Exhibit 800-10
Curb-Opening and Slotted Drain Inlet Length for Total Interception

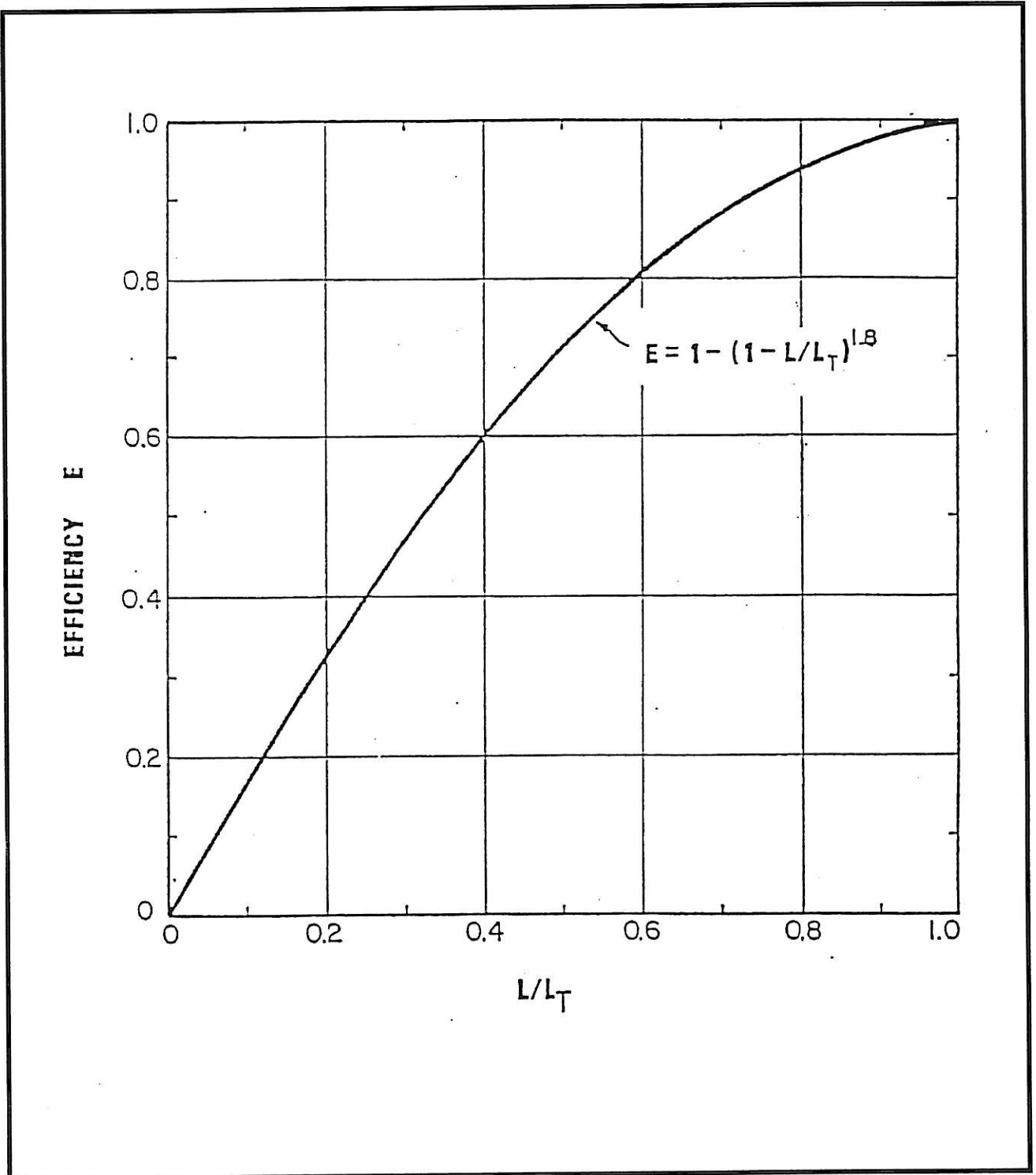

Exhibit 800-11
Curb-Opening and Slotted Drain Inlet Interception Efficiency

SECTION 900 CULVERTS AND BRIDGES

	<u>Page</u>
900.1 INTRODUCTION	192
900.2 DEFINITIONS	192-193
900.3 DETERMINATION OF RUNOFF	193-195
900.4 DESIGN STANDARDS FOR CULVERTS	195
900.5 CULVERT OPERATION	195-200
900.6 CULVERT FLOW CONTROLS	200-201
900.7 OUTLET VELOCITY	202
900.8 CULVERT DESIGN PROCEDURE	202-219
900.9 OUTLET VELOCITY CONTROL	219-224
900.11 BRIDGE HYDRAULIC DESIGN	225
900.11 BRIDGE HYDRAULIC ANALYSIS	225-227
EXHIBITS (900-1 THRU 900-26)	228-256
TABLES (900-10 THRU 900-13)	257-260

NOTE TO USER: Chapter 4 of the A.H.T.D. Drainage Manual is the primary source for Section 900-Culverts and Bridges of this Drainage Manual. It is placed in this manual for the convenience of the user. The City of Bryant adopts Chapter 6 of the A.H.T.D. manual for determination of culvert design.

SECTION 900 CULVERTS AND BRIDGES

900.1 INTRODUCTION

The selection of any structure should be based on hydraulic principles, on the most economical size and shape, and with a resulting headwater depth which will not cause damage to adjacent property. The resultant outlet velocity should be taken into consideration for any possible damaging effects. The allowable headwater elevation is that elevation above which damage may be caused to adjacent property and the roadway. It is this allowable headwater depth that is primarily the basis for sizing a culvert.

The cost of maintaining roadways in good condition is directly related to the adequacy of the means provided for drainage. When adequate provisions are not made, storm water may cause severe erosion of embankment slopes and may undermine culvert outlets. Good drainage design depends on determining the proper frequency and amount of runoff and providing adequate facilities to remove the runoff at such a rate as to avoid undue interference with traffic and also keep maintenance costs at a minimum. In addition, these facilities should be provided at a minimum cost of initial investment.

900.2 DEFINITIONS

- (a) CONJUGATE DEPTH is that depth at which the same discharge would be flowing in a subcritical state after the occurrence of the hydraulic jump.
- (b) CRITICAL DEPTH can best be illustrated as the depth at which water flows over a weir, this depth being attained automatically because it is the depth at which the energy content of flow is a minimum. For a given discharge and channel shape there is only one critical depth. The formula for calculating critical depth in rectangular channels:

$$d_c = \left[\frac{q^2}{32.2} \right]^{1/3}$$

where

q = Discharge per foot of width for rectangular channels in cubic feet per second (Q/W).

For rectangular culverts the critical depth may either be computed from the above formula or read from Exhibit 900-5.

For circular sections the critical depth may be obtained from Exhibit 900-14; Pipe-Arch, Exhibit 900-21.

- (c) CRITICAL SLOPE is that slope at which a given discharge will pass through a structure at critical depth and critical velocity. Increasing the slope above the critical slope does not increase the discharge because culvert capacity is determined by the inlet geometry. It merely makes the water flow at a depth less than critical depth and at a greater velocity. Decreasing the slope to less than critical slope will have a retarding effect upon the discharge, causing the depth of flow to be higher than critical depth and the velocity to be less than critical.
- (d) FREE OUTLETS are those outlets whose TW is equal or lower than critical depth. For culverts having free outlets, lowering of the tailwater has no effect on the discharge (See Type I operation, Figure 900.1).
- (e) FRICTION SLOPE is the only one profile slope that will produce uniform flow for a particular channel cross-section and depth of flow. The equation for friction slope is the modified Manning Formula:

$$\text{Friction Slope} = (Q_n/1.486AR^{2/3})^2$$

- (f) INVERT refers to the flowline of pipe or box (inside bottom).
- (g) PARTIALLY SUBMERGED OUTLETS are those outlets whose TW is higher than critical depth and lower than “D”, the height of culvert. (See Type II operation, Figure 900.2).
- (h) SIDE OR DROP TAPERED INLET indicates a special entrance condition as illustrated in Sections 900.8.3.1 and 900.8.3.2.
- (i) SOFFIT refers to the inside top of pipe or box.
- (j) SUBMERGED OUTLETS are those outlets having a TW elevation higher than the soffit of the culvert. (See Type IV A operation, Figure 900.4).
- (k) TANDEM CULVERTS refer to culverts aligned across a roadway in such a manner that it may be possible for the headwater of the downstream culvert to influence the tailwater of the culvert immediately upstream.
- (l) UNIFORM FLOW is possible only in a channel of constant cross section having the same discharge, velocity and depth of flow throughout the reach. This type of flow will exist in a Type III culvert operation, (Figure 900.3), provided the culvert is sufficiently long to reach a uniform depth of flow.

900.3 DETERMINATION OF RUNOFF

The first step to be considered in the hydraulic design of a culvert is the determination of runoff. There is no single method for determining peak discharge that is applicable to all

watersheds. The method chosen should be a function of drainage area size, availability of data, and the degree of accuracy desired.

It is recommended that the following methods as described in Section 400 (Stormwater Runoff), normally be used as comparison against the others within their respective parameters for increased “power” in hydrology decisions.

(a) Rational Method

This method may be used for drainage areas less than 200 acres.

(b) Soil Conservation Method

This method may be used for drainage areas less than 2000 acres.

(c) Multiple Regression Analysis

This method should be used in rural areas for drainage areas greater than 600 acres, including large bridge type watersheds.

(d) Synthetic Hydrograph Analysis

This method may be used on areas greater than one square mile.

River routing and reservoir routing may be used to adjust storm hydrographs for the effects of storage, channels, long pipes, and the operation of other control structures.

The HEC-1, Flood Hydrograph Computer Program can be used to compute hydrographs by Snyder’s and Clark’s methods, from historical data, and by the SCS Instantaneous Unit Hydrograph Method. It’s capable of performing reservoir and river routing by five different methods, and computing channel diversions where split flow occurs.

The Hydrologic Modeling System is designed to simulate the precipitation-runoff processes of dendritic watershed systems. It is designed to be applicable in a wide range of geographic areas for solving the widest possible range of problems. This includes large river basin water supply and flood hydrology, and small urban or natural watershed runoff. Hydrographs produced by the program are used directly or in conjunction with other software for studies of water availability, urban drainage, flow forecasting, future urbanization impact, reservoir spillway design, flood damage reduction, floodplain regulation, and systems operation.

The program features a completely integrated work environment including a database, data entry utilities, computation engine, and results reporting tools. A graphical user interface allows the user seamless movement between the

different parts of the program. Program functionality and appearance are the same across all supported platforms.

The SCS Technical Release No. 20 is a computer adaptation of NEH-4 which can compute surface runoff resulting from any synthetic or natural rainstorm and route the flow through stream channels and reservoirs.

900.4 DESIGN STANDARDS FOR CULVERTS

900.4.1 Design Frequency Policies

The following flood frequencies are recommended for design:

- | | | |
|----|-------------------------------|---------|
| a. | Principle Arterial: | 50 year |
| b. | Minor Arterial and Collector: | 25 year |
| c. | All other Roads and Streets: | 10 year |

900.5 CULVERT OPERATION

The hydraulic and physical operation of any culvert may be broken down into several basic types. Even though there are numerous combinations of culvert operations, the most common types of culvert operations are shown in Figures 900.1 to 900.5.

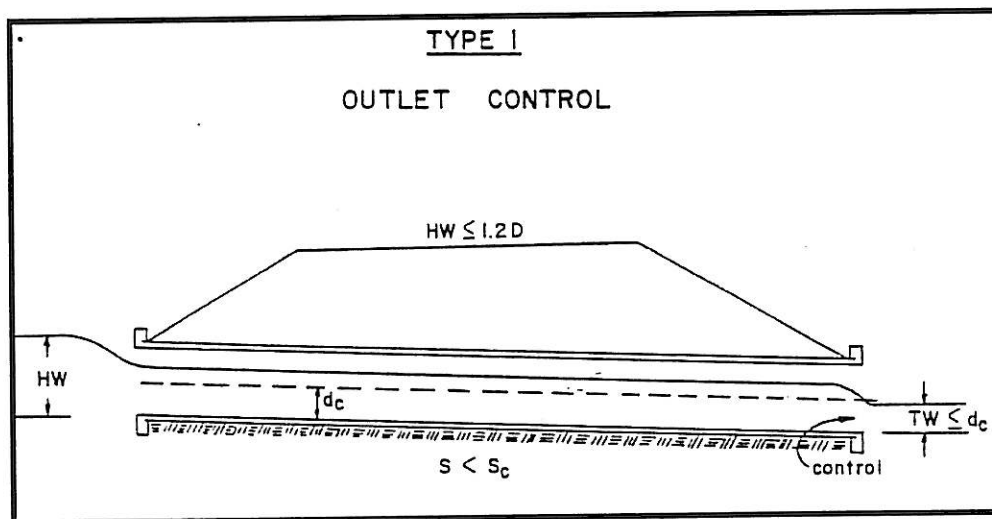

Figure 900.1

Source: Arkansas Highway and Transportation Department Drainage Manual
Conditions

The entrance is unsubmerged ($HW \leq 1.2D$), the slope at design discharge is sub-critical ($S < S_c$), and the tailwater is below critical depth ($TW \leq d_c$).

NOTE: 1.2D is an empirical value determined by research

The above condition is a common occurrence where the natural channels are on flat grades and have wide, flat flood plains. The control is critical depth at the outlet.

$$HW = D_c + \frac{V_c^2}{2g} + h_e + h_f - SL$$

where

d_c = critical depth

V_c = critical velocity (based on d_c)

g = 32.2 feet per second per second

h_e = entrance head = $K_e \frac{V_c^2}{2g}$

K_e = entrance coefficient found in Table 900.10.

H_f = friction head = friction slope times "L"

L = length of culvert

Friction slope = that slope at which $1.1 d_c$ would produce uniform flow

SL = vertical drop in culvert from upstream flow line to downstream flowline

The outlet velocity is the discharge divided by the area of flow at critical depth which is critical velocity (V_c).

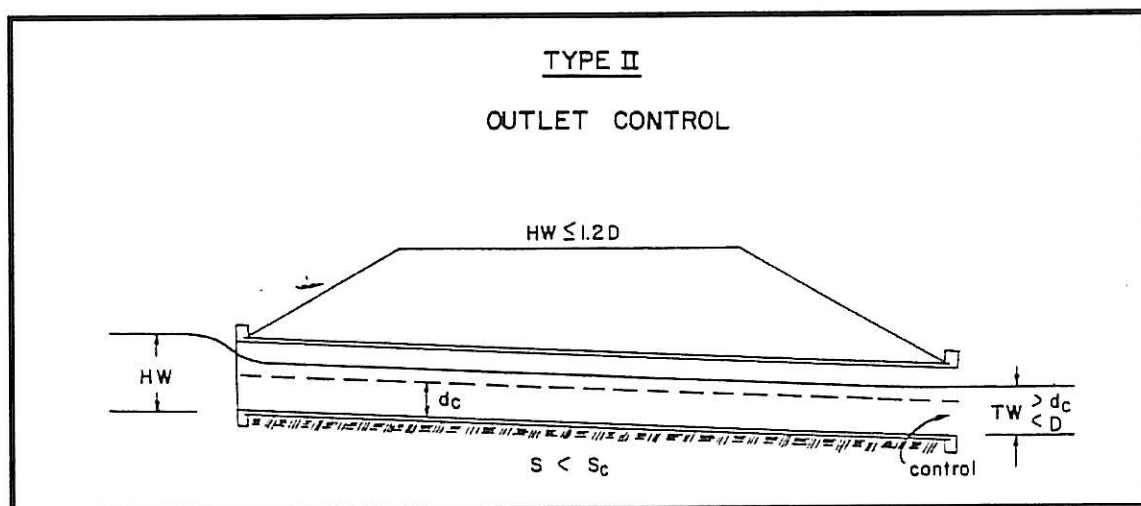

Figure 900.2

Source: Arkansas Highway and Transportation Department Drainage Manual
Conditions

The entrance is unsubmerged ($HW \leq 1.2D$), the slope at design discharge is subcritical ($S < S_c$), the tailwater is above critical depth ($TW > d_c$) and tailwater is less than D ($TW < D$).

The above condition is a common occurrence where the channel is deep, narrow and well defined. The control is tailwater at the culvert outlet.

$$HW = TW + \frac{V_{TW}^2}{2g} + h_e + h_f - SL$$

where:

TW = tailwater depth at outlet

V_{TW} = velocity based on TW depth

$$h_e = K_e \frac{V_{TW}^2}{2g}$$

h_f = friction head = friction slope times "L"

friction slope = slope at which TW depth would be uniform depth. All other terms are as previously defined.

Outlet velocity (V_{TW}) is the discharge divided by the area of flow in the culvert at tailwater depth.

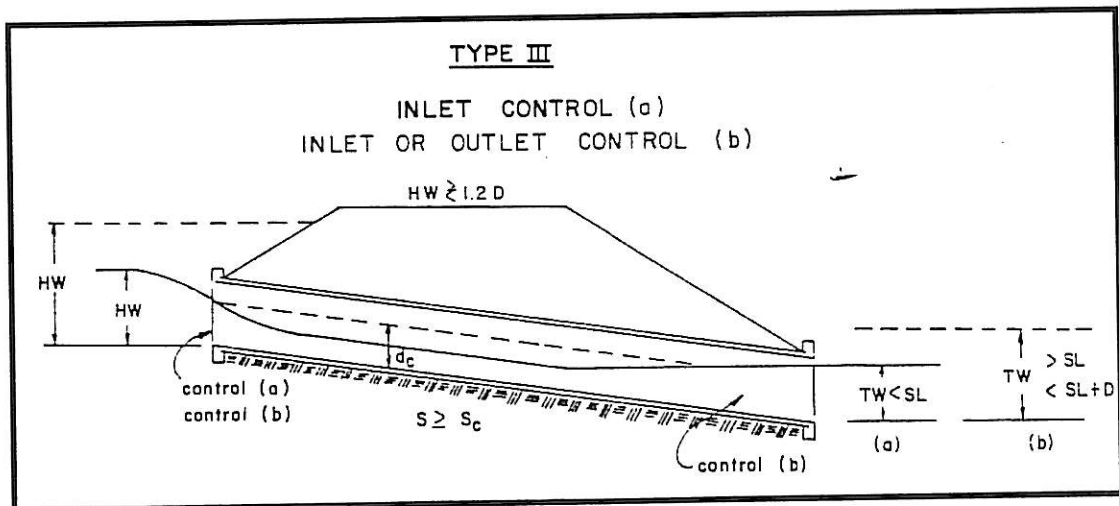

Figure 900.3

Source: Arkansas Highway and Transportation Department Drainage Manual Conditions

The entrance may be submerged or unsubmerged (HW greater than or less than $1.2D$) and the slope at design discharge is equal to or greater than critical slope ($S \geq S_c$).

Tailwater should be less than “SL” when “TW” elevation is lower than upstream flowline. Tailwater will be less than “SL” when “TW” elevation is above upstream flowline and less than “SL+D” (TW elevation is below upstream soffit).

This condition is a common occurrence for culverts in rolling or mountainous country. The control is critical depth at the entrance for HW values up to about 1.2D. The control is the entrance geometry for HW values over about 1.2D.

In some cases, control for this type of operation may be at the entrance or the outlet or control may transfer itself back and forth between the two. For this reason, it is recommended that HW be determined for both entrance control and outlet control and the higher of the two determinations be used.

Entrance control is determined from empirical curves in the form of nomographs (See Exhibits 900-7, 900-15, 900-16 and 900-23).

OUTLET VELOCITY

- (a) If TW is greater than D, outlet velocity is based on full flow at the outlet. If TW is less than D, outlet velocity is based on uniform depth for the culvert. Uniform depth is simply that depth of water for a given discharge, culvert slope, and geometry at steady flow.
- (b) If TW depth is less than D, outlet velocity should be based on TW depth. If TW depth is greater than D, outlet velocity should be based on full flow at the outlet.

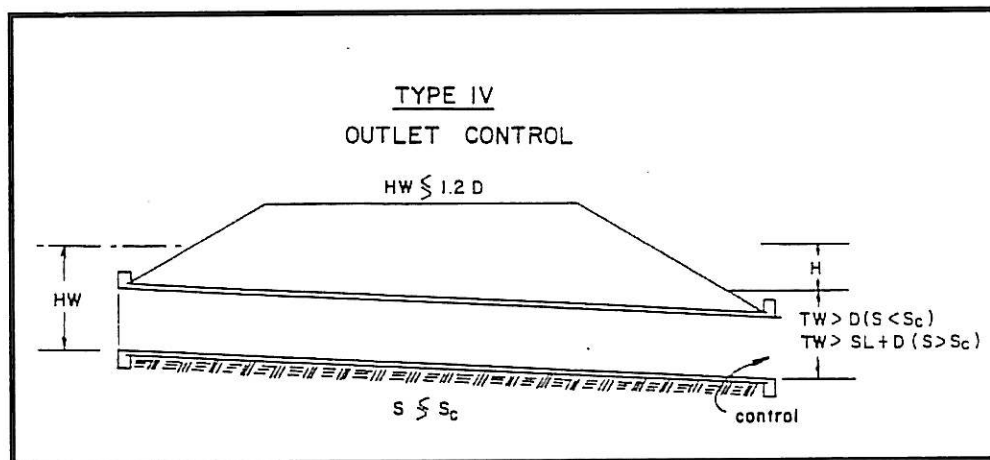

Figure 900.4

Source: Arkansas Highway and Transportation Department Drainage Manual
Conditions
(Submerged Outlet)

The entrance is submerged (HW greater than or less than 1.2D).
 The tailwater completely submerges the outlet.

$$HW = H + TW - SL$$

where:

H = total head loss of discharge through culvert and
 $H = h_v + h_e + h_f$

where:

h_v = velocity head $\frac{V^2}{2g}$ (where v is based on full flow in culvert).

h_e = entrance head $K_e h_v$

h_f = friction head $S_f L$ (where S_f is based on full flow in culvert). All other terms have been previously defined.

H may be determined directly from nomographs on Exhibits 900-4, 900-12 and 900-13.

Outlet velocity is based on full flow at the outlet.

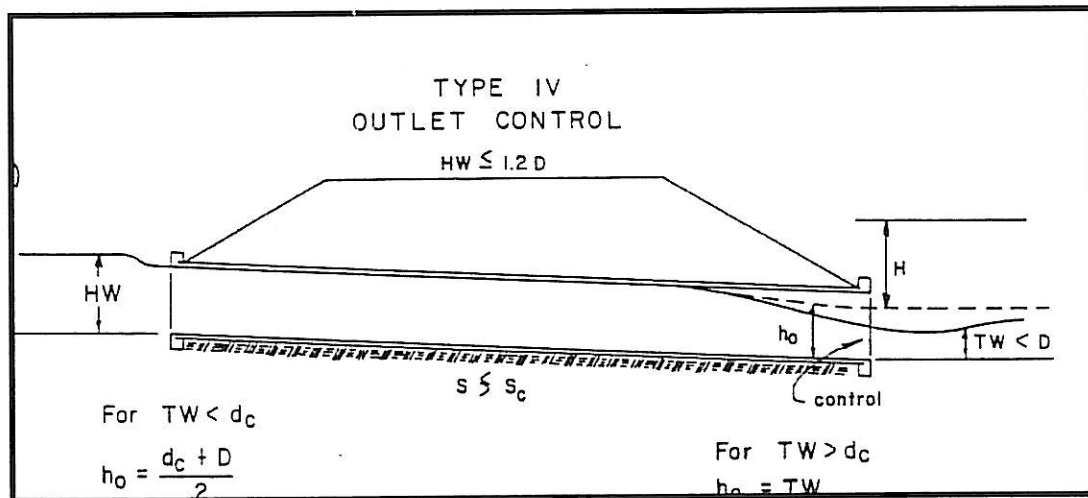

Figure 900.5
 Conditions

Source: Arkansas Highway and Transportation Department Drainage Manual
 (Partially Submerged Outlet)

The entrance is partially submerged ($HW \leq 1.2D$). The tailwater depth is less than D ($TW < D$).

$$HW = H + h_o - SL$$

where:

H_o = empirical approximation of equivalent hydraulic grade line.

$H_o = (d_c + D)/2$ if TW depth is less than critical depth at design discharge.
If TW is greater than critical depth, then $h_o = TW$.

Outlet velocity is based on critical depth if TW depth is less than critical depth. If TW depth is greater than critical depth, outlet velocity is based on TW depth.

900.6 CULVERT FLOW CONTROLS

Generally, the hydraulic control in a culvert will be at the culvert outlet if the culvert slope is less than the critical slope. Inlet control usually governs if the culvert slope is greater than the critical slope. Other factors that determine how the culvert performs can be listed as physical makeup of the structure and the leading and trailing water surface profiles.

900.6.1 Outlet Control

For outlet control, factors such as type of opening, cross section area, barrel slope, barrel length, barrel roughness, head losses due to tailwater are predominate in controlling the headwater of the culvert as shown in Figure 900.6. These separately or conjointly, create physical resistances that retard the flow of water. As the resistance accumulates, the flow begins to slow and increase in depth. At some point, when the resistances mount, the water may cease to flow freely and back up in the structure and flood the upstream drainage basin.

900.6.2 Inlet Control

For inlet control, the entrance characteristics of the culvert area such that the entrance head losses are predominate in determining the headwater of the culvert as shown in Figure 900.7. The barrel will carry water through the culvert faster than the water can enter the culvert.

If the slope of the culvert is greater than critical slope and the tailwater depth is less than SL or tailwater elevation is lower than the upstream flowline of the culvert, headwater is based on inlet control for all ranges of discharges.

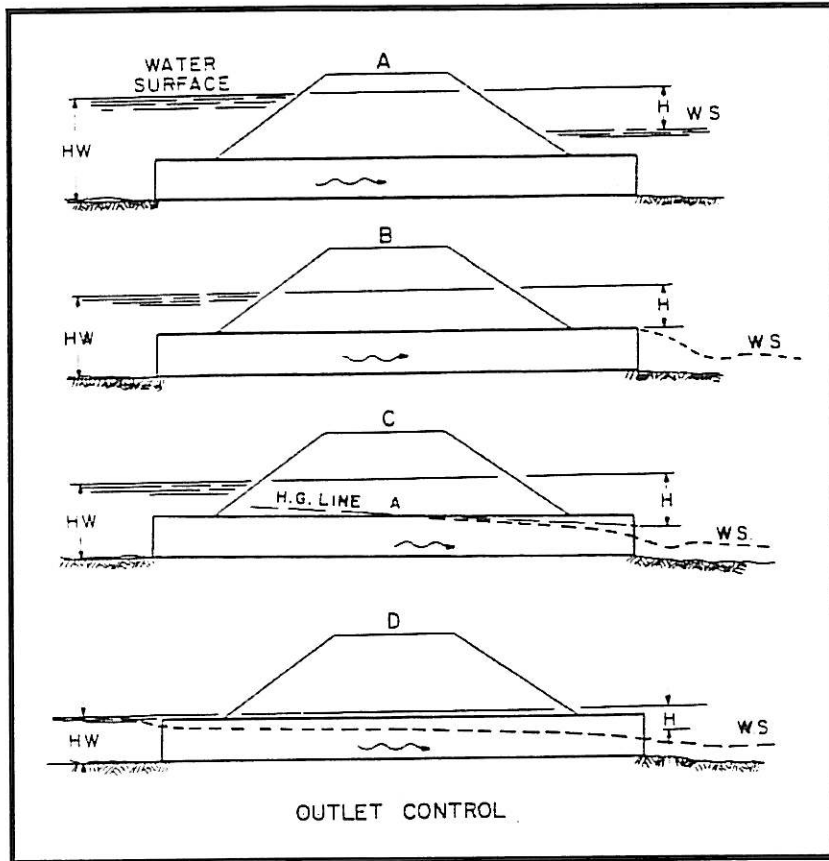
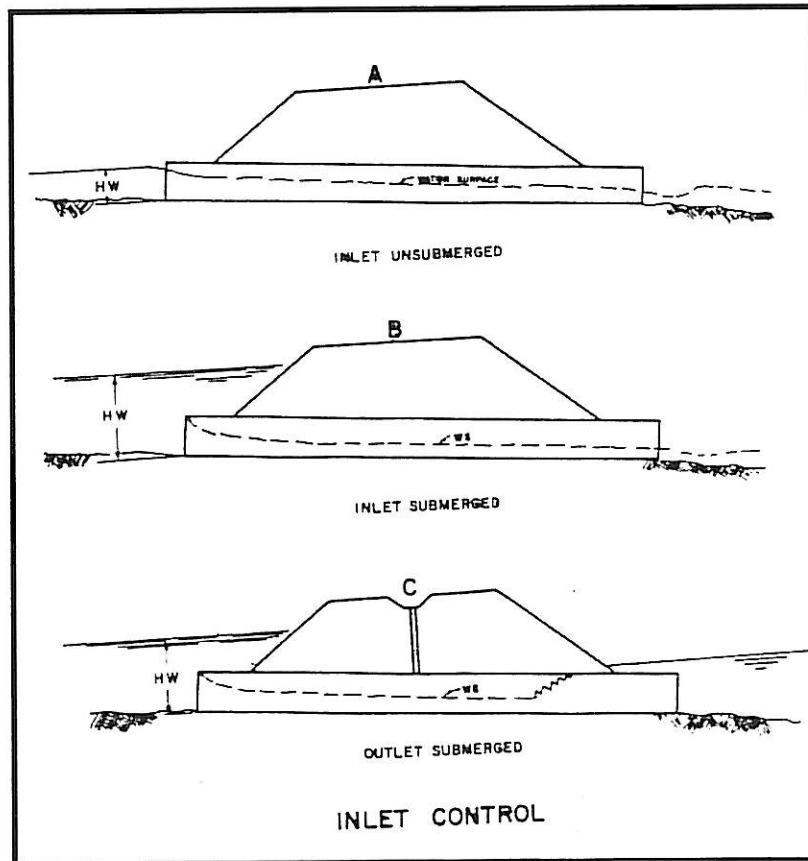

Figure 900.6

Source: Arkansas Highway and Transportation Department Drainage Manual

Figure 900.7



900.7 OUTLET VELOCITY

The design of any culvert should take into consideration the soil type, the outfall velocity and the depth of flow.

Outlet velocity in any properly designed culvert is normally greater than the velocity in the natural channel. The engineer must bear in mind, while attempting to control flow at a structure outlet, that the main objective is to return the flow to the normal flow in the natural stream, in an economical and efficient manner. A recommended threshold of erosive velocity is 8fps. Ranges of velocities, relative to soil types, lined and unlined can be found in Section 500, Open Channel Flow.

It should be noted at this point that if the culvert has been properly sized according to allowable headwater elevation, it is almost always more economical to protect against excessive outlet velocity with riprap and/or velocity control devices than to try to adjust the culvert size to reduce the excessive outlet velocity.

900.8 CULVERT DESIGN PROCEDURE

The hydraulic design of a culvert consists of an analysis of the performance of the culvert in conveying flow from one side of the roadway to the other. To meet this conveyance function adequately, the design must include consideration of the variables discussed in the following paragraphs.

900.8.1 Culvert Design Data

The proper design of a culvert requires the definite knowledge of some items and the assumption of other items. The items which should be known either by observation or calculation include:

1. design discharge - Q_d
2. design tailwater - TW
3. culvert slope - S
4. allowable headwater - AHW

The items which must be assumed or estimated include:

5. allowable outlet velocity - V_o
6. culvert length - L
7. entrance conditions
8. culvert material and shape (box, pipe, metal, concrete, etc.)
9. maximum allowable depth of barrel should usually not be greater than AHW.

Only after all the basic culvert design data is assimilated should the culvert size be attempted.

900.8.2 Example Problem No. 1

The following is a step by step culvert design procedure. It should be noted that the procedure incorporates the items as shown on tabulation sheets, Tables 900.7 and 900.8.

GIVEN:	Design Discharge (Q_{50})	=	1,000 cfs
	Slope of stream BPWD (S_o)	=	0.071 ft. / ft.
	Allowable headwater elevation	=	200.0
	Elevation outlet invert	=	182.9
	Culvert length (L)	=	100 ft.

Downstream channel approximates an 8ft. wide trapezoidal channel with 2:1 side slopes, Manning “n” of 0.03 and a slope (S_o) of 0.071 feet per foot.

REQUIRED: Design a culvert that will adequately convey the design discharge. The culvert should have the smallest possible barrel to pass design Q without exceeding AHW elevation. Try a reinforced concrete box culvert with “n” = 0.012.

SOLUTION:

900.8.2.1 Step 1 – Selecting Culvert Size

The computations involved in selecting the smallest feasible barrel which can be used without exceeding the design headwater elevation is summarized in the tabulation sheet, titled “Culvert Computations”, Table 900.1.

INITIAL DATA:

Enter initial data and complete required information for first approximation. The square feet of opening for the initial trial size may be estimated by the ratio of design discharge divided by 10.

TAILWATER:

The tailwater depth is influenced by conditions downstream of the culvert outlet. If the culvert outlet is located near the inlet of a downstream culvert, then the headwater elevation of the downstream culvert may define the tailwater depth for the upstream culvert. If the culvert outlet is operating in free outfall condition then the tailwater is taken as 0.0.

If the culvert discharges into an open channel, then the tailwater is equal to the normal depth of flow in that channel. Exhibit 900-3 provides a graphical solution for normal depth or may be calculated by Manning’s Formula:

$$Q = \frac{1.486}{n} AR^{2/3} S^{1/2}$$

In any case, the tailwater depth is defined as the depth of water measured from the flow line of the culvert (invert) at the outlet, to the water surface elevation at the outlet.

Enter tailwater depth in Column 8 and applicable stream data in upper left hand portion of Culvert Computation Form.

900.8.2.2 Step 2 – Perform Outlet Control Calculations

These calculation are performed before inlet control calculations in order to select the smallest feasible barrel which can be used without the required headwater elevation in outlet control exceeding the allowable headwater elevation.

- Column 1: Enter the span time height dimensions (or diameter of pipe) of culvert.
- Column 2: Enter the type of structure and design of entrance.
- Column 3: Enter the design discharge or quotient of design discharge divided by the applicable denominator.
- Column 4: Enter the Entrance Loss Coefficient from Table 900.10.
- Column 5: Enter the head from the applicable outlet control nomograph, in the example problem use Exhibit 900-4.
- Column 6: Enter the critical depth from appropriate nomograph, in the example problem use Exhibit 900-5. Critical depth cannot exceed height of culvert opening.
- Column 7: For tailwater elevations less than the top of the culvert at the outlet, headwater is found by solving for h_o using the following equation:

$$h_o = \frac{d_c + D}{2}$$

where: h_o = vertical distance in feet from culvert invert at outlet to the hydraulic grade line in feet.

d_c = critical depth in feet

D = height of culvert opening in feet

- Column 8: Enter the tailwater elevation from initial data shown at top of form. Refer to tailwater comments under STEP 1 for additional guidelines.
- Column 9: Enter the product of culvert length times the slope.

Column 10: Headwater elevation required for culvert to pass flow in outlet control (HW_o) is computed by the following equation:

$$HW_o = H + h_o - LS$$

Note: Use TW elevation in lieu of h_o where $TW > h_o$.

Additional trials may be required. Space for additional trials is provided on Culvert Computations Form.

900.8.2.3 Step 3 – Perform Inlet Control Calculations for Conventional and Beveled Edge Culvert Inlets

After minimum barrel size has been determined under STEP 2, the next procedure is similar to that used in FHWA's Hydraulic Engineering Circular Number 5, "Hydraulic Charts for the Selection of Highway Culverts."

The computations involved in computing inlet headwater elevation is summarized in the tabulation sheet used in STEP 2, titled "Culvert Computations", Table 900.1.

Column 11: Enter ratio of headwater to height of structure from Exhibit 900-7.

Column 12: HW is derived by multiplying Column 11 by the height (or diameter) of culvert.

Column 13: Enter greater of two headwaters (Column 10 or 12).

Column 14: If inlet control governs, outlet velocity equals Q/A , where A is defined by the cross-sectional area of normal depth of flow in the culvert barrel at "S". Manning's Formula may also be used:

$$Q = \frac{1.486 AR^{2/3} S^{1/2}}{n}$$

If outlet control governs, outlet velocity equals Q/A , where A is the cross-sectional area of flow in the culvert barrel at the outlet.

Column 15 & 16: Figures shown in this column are believed to be self explanatory.

900.8.3 Improved Inlets

- (a) If headwater (inlet control) is lower than headwater required for outlet control, the barrel operates in outlet control at design "Q", additional analysis for improved inlets not required.
- (b) If computed headwater is within the designer's judgement of acceptable limits and headwater does not exceed allowable headwater (AHW) elevation, additional analysis for improved inlets not required.

- (c) If the computed headwater is excessive in the designer's judgement from the standpoint of aesthetics, economy, risk and other engineering reasons, a need for inlet geometry refinement is indicated. If square edges were used in STEP 3 above, repeat with beveled edges. If beveled edges were used, calculations for side-tapered and slope-tapered inlets should be performed.

900.8.3.1 Step 4 – Perform Side-Tapered Inlet Design Calculations

The same concept is involved here as with conventional and beveled edge inlet culvert design.

The computations involved in computing side-tapered inlets (Figure 900.8) are summarized in the tabulation sheet titled "Improved Inlet for R.C. Box Culverts", Table 900.4.

INITIAL DATA:

Enter initial data and information obtained from STEPS 2 and 3.

- Column 1: Enter ratio of headwater above the face section invert (H_f) to the height of box culvert (D) using the formula:

$$H_f = \frac{HW_f - \text{Elevation Throat Invert} - 1}{D}$$

where:

H_f = headwater above the face section invert in feet

D = height of box culvert in feet

HW_f = allowable headwater elevation required for flow to pass face section in face control in feet.

- Column 2: The ratio of $Q/B_f D^{3/2}$ is derived by the use of Exhibit 900-9.
- Column 3: Enter the height of box culvert (D) to the 3/2 power.
- Column 4: The minimum width of face section (B) is the quotient of design discharge (Q) divided by the product of Column 2 times Column 3. The derived width should be rounded up to the nearest foot.
- Column 5: Enter the length of taper (L_1) by using the formula:

$$L_1 = \frac{B_f - NB}{2} \text{ Taper}$$

where:

L_1 = length of taper, in feet.

B_f = width of face section, in feet.

NB = number of barrels times width of culvert barrel

Taper = design taper slope. Side taper ratios may range from 6:1 to 4:1. The 4:1 taper is recommended as it results in a shorter length. Tapers greater than 6:1 may be used, but performance will be underestimated. For 4:1 tapers, multiply the quotient by 4; for 6:1 tapers, multiply the quotient by 6.

Column 6: Enter the design slope of culvert in feet per foot. The product of (S) times L_1 should be <1 foot. If >1 foot, redesign or proceed to STEP 5.

900.8.3.2 Step 5 – Perform Slope-Tapered Inlet Design Calculations

A slope-tapered inlet design (Figure 900.8) may be used if a FALL is required on the throat by use of a FALL in the inlet of the slope-tapered inlet.

The minimum face design is one whose performance does not exceed the allowable headwater elevation at design “Q”. However, a “balanced” design requires that full advantage be taken of the increased capacity and/or lower headwater requirement gained through use of various falls.

Face dimensions and inlet length increase for the slope-tapered inlet as the capacity of the culvert is increased by additional FALL on the throat. No additional head is created for the face by placing additional FALL on the throat.

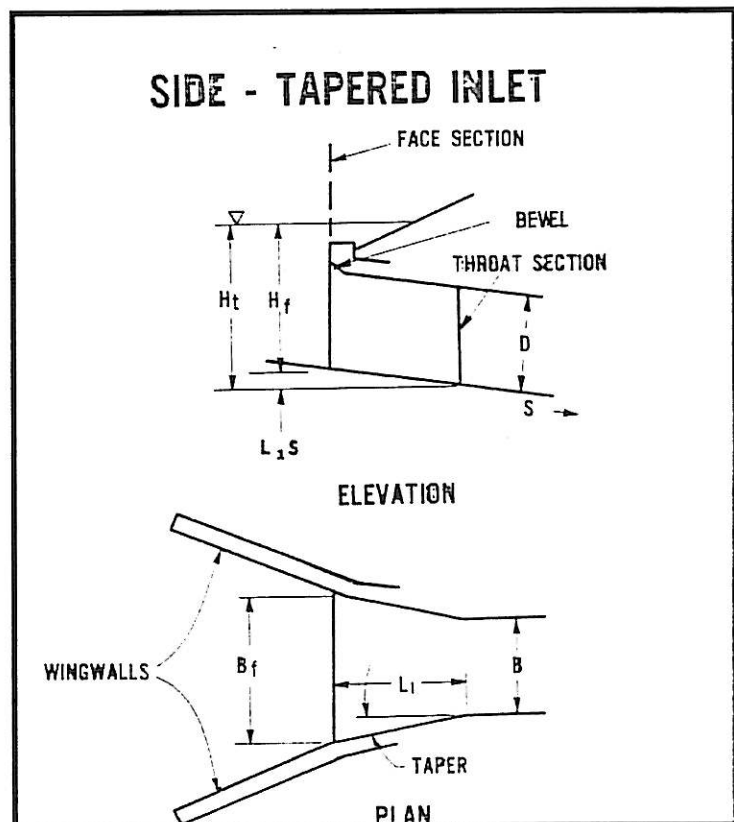

Figure 900.8

Source: Arkansas Highway and Transportation
Department Drainage Manual

The steps followed in the slope-tapered inlet design are:

- a. Compute depression (FALL) below the stream BPWD elevation required to pass design discharge.
- b. Compute allowable head above the face section invert (H_f) by taking the difference between the allowable headwater elevation and stream BPWD elevation.
- c. Determine dimensions for trial options.
- d. Compare construction costs for various options, including the cost of FALL on the throat.
- e. Select design with incremental cost warranted by increased capacity and improved performance.

The detailed computations involved in computing slope-tapered inlets are summarized in the tabulation sheet used in STEP 4, titled “Improved Inlet for R.C. Box Culverts”, Table 900.2.

Column 7: Enter face invert elevation. Normally this is the approximate stream BPWD elevation at face.

Column 8: Enter the ratio of $Q/NBD^{3/2}$
 Q = design discharge
 N = number of barrels
 B = width of culvert barrel
 D = height of culvert

Column 9: The depth of pool, or head (H_i), above the throat invert is derived graphically by the use of Exhibit 900-10.

Column 10: Elevation of throat invert is derived by subtracting Column 8 from allowable headwater elevation. If the vertical distance below the stream BPWD elevation (FALL) exceeds an allowable amount (as determined by the designer) the normal barrel dimensions should be increased. Improved inlet dimensions should be recalculated beginning with Column 1 for side-tapered inlet.

Column 11: Enter ratio of headwater above the face section invert (h_f) to the height of box culvert (D) using the formula:

$$H_f/D = HW_f - \text{Elevation face invert} / D$$

Column 12: The ratio of $Q/B_f D^{3/2}$ is derived by the use of Exhibit 900-11.

Column 13: The minimum width of face section (B_f) is the quotient of design discharge (Q) divided by the product of Column 3 times Column 12. The derived width should be rounded up to the nearest foot.

Column 14: “ L_3 ” is the dimension relating to the slope bend point of the culvert barrel soffit to the point of normal barrel section. Refer to Figure 900.9 for a pictorial definition. Minimum “ L_3 ” = 0.5 NB

where: N = number of barrels
 B = width of culvert barrel

Column 15: “ L_2 ” is the horizontal dimension of the improved inlet from the face to the soffit slope bend point of the culvert barrel. Refer to Figure 900.9 for a pictorial definition. The length of slope “ L_2 ” should be derived by using the formula:

$$L_2 = (\text{face invert elevation} - \text{throat invert elev.}) S_f$$

where:

S_f – slope of FALL (use 2 for 2:1 slope and 3 for 3:1 slope)

Column 16: Column 15 should be checked for dimension adjustments that may be required of “ L_3 ” or design Taper by using the formula:

$$L_2 = \frac{B_f - NB}{2} (\text{Taper} - L_3)$$

where:

B_f = width of face section in feet

NB = number of barrels times width of culvert barrel in feet.

Taper = sidewall flare

$L_3 = 0.5 NB$

Column 17: If Column 16 is greater than Column 15, “ L_3 ” should be adjusted using the formula:

$$L_3 = \frac{B_f - NB}{2} (\text{Taper} - L_2)$$

All terms are as previously defined.

Column 18: If Column 15 is greater than Column 16, TAPER length should be adjusted using the formula:

$$\text{Taper} = \frac{L_2 + L_3}{2}$$

$$(B_f - NB) / 2$$

Column 19: Enter sum of Columns 14 (or 17) and 15

Enter selected geometry in the upper right hand corner of Table 900.2.

Conclusion – Example Problem No. 1

Since the requirements called for the smallest possible reinforced concrete box culvert, the barrel should be a single 8 ft. x 6 ft.

Selection of the improved inlet should be based on cost and site considerations. A side or slope-tapered design meets the design discharge and AHW requirements and appears to be cost effective.

Since the depression (FALL) is only 1 foot and assuming the natural stream BPWD can be lowered at the inlet without adverse effects, it is recommended that the beveled edge-side tapered inlet be used at this location.

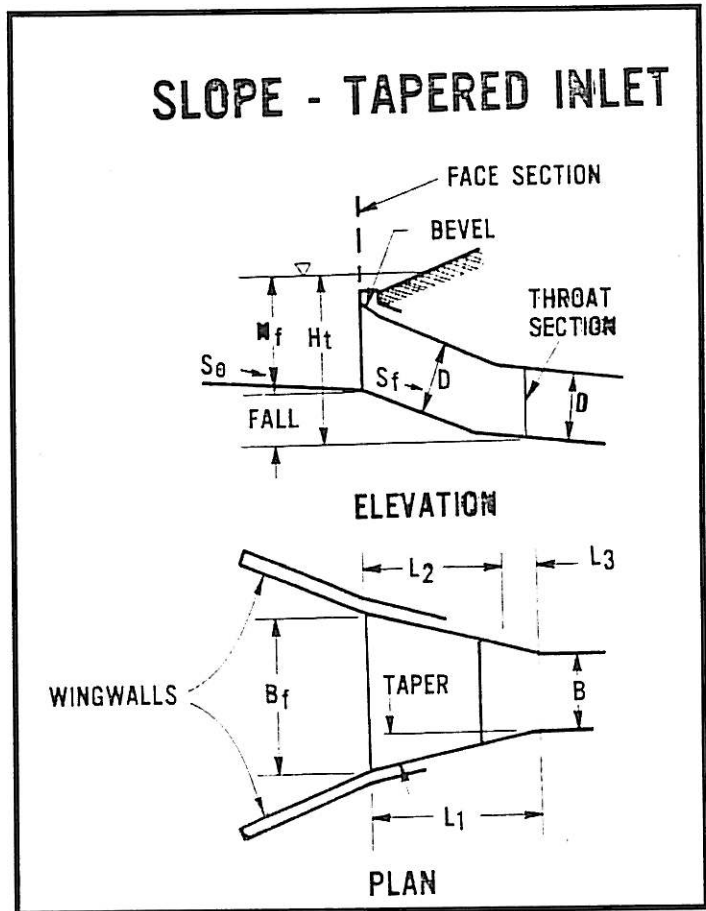

Figure 900.9

Source: Arkansas Highway and Transportation Department Drainage Manual

FORM HYD 4-2
 PROJECT Example No. 1
 IMPROVED INLET FOR R.C. BOX CULVERTS
 DESIGNER HYD
 DATE 11-11-01

INITIAL DATA
 $Q_{50} = 1000$ cfs $S_0 = 0.071$
 AHW EL. 200 ft. L = 100 ft.
 El. Stream bed at face 190.0 ft.
 Allowable Headwater 10.0 ft.
 TAPER = 4 (4:1 to 6:1)
 $S_f = 3$ (2:1 to 3:1)
 Barrel Shape and Material R.C.B.
 Inlet Edge Description BEVELED
 $H_f = 1$ $B = 8$ ft. $D = 6$ ft.

SKETCH

 SIDE-TAPERED
 SLOPE-TAPERED (Vertical Face)

SELECTED DESIGN
 $B_f = 15.0$ ft. $L_3 =$ ft.
 $L_2 =$ ft. $L_1 = 14.0$ ft.
 Bevels' Angle 30°
 $d = 6$ in.
 TAPER 4:1
 $S_f =$
 $S = 0.071$ ft./ft.

SIDE TAPERED (n)										SLOPE TAPERED ($D/4 \leq F_{all} \leq 1.5 D$)										COMMENTS
H_f/D	C/B	$D^3/2$	Min B_f	L_1	S	Elev. Face Invert	C	H_f	Elev. Throat Invert	H_f/D	C/B	Min B_f	Min L_3	L_2	Check L_2	Adj. L_3	Adj. Taper	L_1		
1	2	3	4	5	6	7	8	9	10	11	12	13	14	15	16	17	18	19	20	
1.7	4.8	14.7	15.0	14.0	0.071	190.0	8.5	13.5	186.5	1.7	5.1	14.0	4.0	10.5	8.0	-	4.83:1	14.5	OK	

(a) $H_f/D = (HW_f - \text{Throat Invert Elev.} - 1) / D$
 (b) Use Chart 4-9, page 4-66.
 (c) $Min B_f = \frac{C}{(D^3/2)^{0.5}}$
 (d) $L_1 = \frac{B_f - NB}{2}$ (TAPER)
 (e) Use Chart 4-10, page 4-67.
 (f) $H_f/D = (HW_f - \text{Face Invert Elev.}) / D$
 (g) Use Chart 4-11, page 4-68.
 (h) $Min L_3 = 0.5 NB$
 (i) $L_2 = (\text{Elev. Face Invert} - \text{Elev. Throat Invert}) / S_f$
 (j) Check $L_2 = \frac{B_f - NB}{2}$ TAPER- L_3
 (k) If Column 16 > 15, Adjust $L_3 = \frac{B_f - NB}{2}$ TAPER - L_2
 (l) If Column 15 > 16, Adjust TAPER = $(L_2 + L_3) / \frac{B_f - NB}{2}$
 (m) $L_1 = L_2 + L_3$
 (n) Elev. Face Invert - Elev. Throat Invert ≤ 1 ft.

Table 900.1

Source: Arkansas Highway and Transportation Department Drainage Manual

Table 900.2

FORM HYD 4-1
 PROJECT Example No. 1
 CULVERT COMPUTATIONS (SQUARE AND BEVELED EDGES)
 DESIGNER HYD
 DATE 11-11-01

HYDROLOGIC AND CHANNEL INFORMATION
 HYDROLOGY
 $Q_1 = 50 = 1000$ cfs
 $Q_2 =$ cfs
 $n = 0.03$
 $S_0 = 0.071$

 STREAM DATA
 $TW_1 = 3.2$
 $TW_2 =$
 STATION: 30+00
 FIN. GR. EL. 201.0
 HW_f EL. 200.0
 AHW = 10.0 (H_f)
 H_f EL. 190.0
 $S = 0.071$ ft./ft.
 $L = 100$ ft.
 EL. 182.9

TRIAL NO.	SIZE	STRUCTURE TYPE & ENTRANCE DESIGN	Q	HEADWATER COMPUTATION										OUTLET VELOCITY ft./sec.	COST	COMMENTS
				Q/NB	OUTLET CONTROL					INLET CONT.		CONTROL LING HW				
			$\frac{Q}{NB D^3/2}$	(a) K_e	(b) H	(c) d_c	(d) h_0	(e) TW	(f) LS	(g) HW_0	(h) $\frac{HW}{D}$	HW				
0	1	2	3	4	5	6	7	8	9	10	11	12	13	14	15	16
1	8x6	SQ. EDGE	125	0.4	11.0	>6	6	3.2	7.1	9.9						CLOSE TO AHW - TRY 7x6'
2	7x6	"	143	0.4	15.0	>6	6	3.2	7.1	13.9						EXCEEDS AHW - CHECK TRIAL 1 FOR BEVELED EDGE
3	8x6	BEVELED	125	0.2	9.5	>6	6	3.2	7.1	8.4	3.1	18.6	18.6	21		LOWERED HW ₀ 1.5'. H _f EXCEEDS AHW - TRY SIDE-TAPER

(a) Entrance loss coefficient, Refer to Table 4-10, page 4-60.
 (b) " d_c " cannot exceed D.
 (c) $h_0 =$ or TW, whichever is larger.
 (d) TW = d_n in natural channel, or other downstream control.
 (e) $HW_0 = H + H_0 - LS$
 (f) Use Chart 4-7, page 4-64, for Conventional f
 (g) Use Chart 4-8, page 4-65, for Beveled Edge.

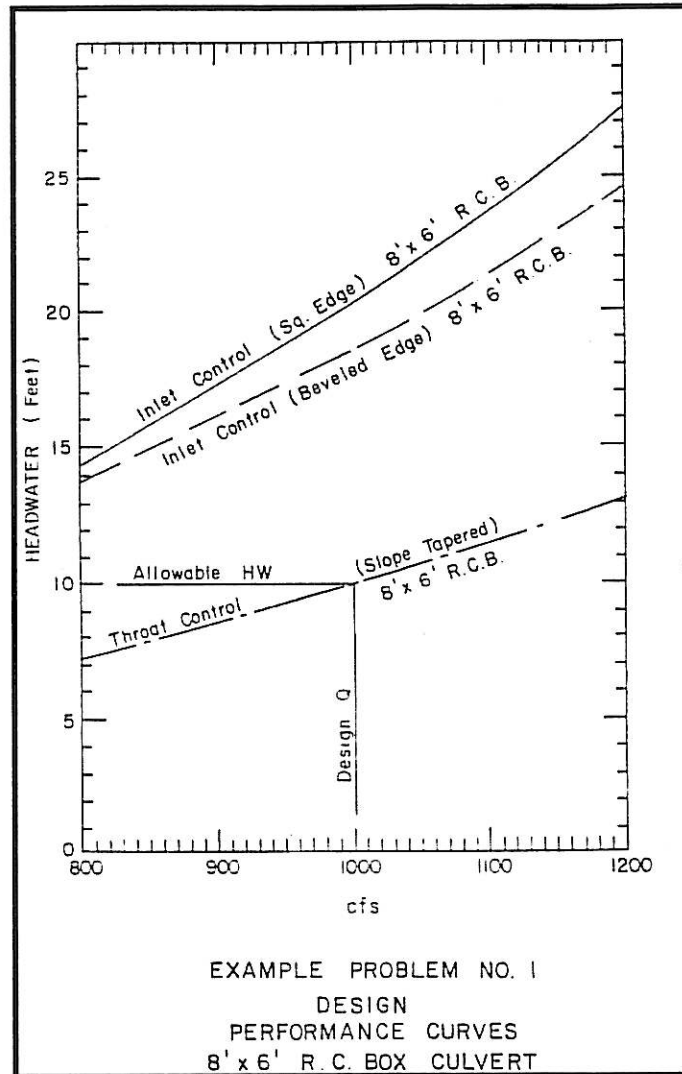

Figure 900.10

Source: Arkansas Highway and Transportation Department Drainage Manual

Example Problem No. 2

GIVEN: Design Discharge (Q_{25}) = 1,500 cfs
 Slope of stream BPWD (S_0) = 0.02 ft. / ft.
 Allowable headwater elevation = 300.0
 Elevation outlet invert = 290.0
 Culvert length (L) = 100 ft.

Downstream channel approximates at 12 ft. wide trapezoidal channel with 2:1 slopes, Manning "n" of 0.03 and a slope (S_0) of 0.02 feet per foot.

REQUIRED:

Design a culvert that will adequately convey the design discharge. The culvert should have the smallest possible barrel to pass design Q without exceeding AHW elevation. Try a reinforced concrete box culvert with $n = 0.012$.

SOLUTION:

Use procedures as outlined in STEPS 1 through 5 of Example Problem No. 1.

COMPUTATIONS:

See Table 900.3 and 900.4, respectively for detailed computations.

CONCLUSION – EXAMPLE PROBLEM NO. 2

Again, the requirements called for the smallest possible reinforced concrete box culvert. The barrel should be a double 10 ft. x 7 ft. R.C. box culvert.

As in problem No. 1, selections of the improved inlet should be based on cost and site considerations. A side-tapered design meets the design discharge and AHW requirements.

The existing stream BPWD slope restricted FALL to $D/4$. Therefore slope-tapered inlet computations are not applicable.

It should be noted that the face width (B_f) is the total clear face width needed. The width of the division wall must be added to this value in order to size the face correctly.

No design procedure is available for side-tapered inlet culverts with more than two barrels.

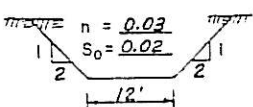
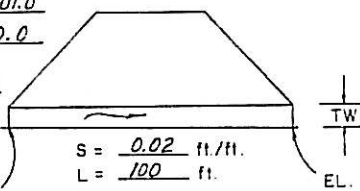
FORM HYD 4-1		CULVERT COMPUTATIONS (SQUARE AND BEVELED EDGES)						DESIGNER: <u>HYD</u>									
PROJECT: <u>Example No.2</u>								DATE: <u>11-11-81</u>									
<p style="text-align:center;">HYDROLOGIC AND CHANNEL INFORMATION</p> <p>HYDROLOGY</p> <p>Q_1 <u>25</u> = <u>1500</u> cfs Q_2 _____ = _____ cfs</p> <p style="text-align:center;">STREAM DATA</p> <p>T_{w1} = <u>5.0</u> T_{w2} = <u>4.8</u></p> <p style="text-align:center;">$n = 0.03$ $S_0 = 0.02$</p>  <p style="text-align:center;">OUTLET CHANNEL (APPROX. DIMENSIONS)</p>						<p style="text-align:center;">SKETCH</p> <p style="text-align:right;">STATION: <u>200+00</u></p> <p>FIN. GR. EL. <u>301.0</u> HW_f EL. <u>300.0</u> AHW = <u>8.0</u> (H_f)</p>  <p style="text-align:right;">S = <u>0.02</u> ft./ft. L = <u>100</u> ft.</p> <p style="text-align:right;">EL. <u>290.0</u></p>											
TRIAL NO.	SIZE	STRUCTURE TYPE & ENTRANCE DESIGN	Q Q/NB C NBD ^{3/2}	HEADWATER COMPUTATION										CONTROL LING HW	OUTLET VELOCITY ft./sec.	COST	COMMENTS
				(a) K _e	H	(b) d _c	(c) h ₀	(d) TW	LS	(e) HW ₀	(f) HW/D	HW					
0	1	2	3	4	5	6	7	8	9	10	11	12	13	14	15	16	
1	DBL. 6x6	SQ. EDGE	125	0.4	10.5	>6	6	4.8	2.0	14.5							HW ₀ > AHW - TRY DBL. 7x7
2	DBL. 7x7	"	107	0.4	5.7	>7	7	4.8	2.0	10.7							" " - TRY DBL. 8x7
3	DBL. 8x7	"	94	0.4	4.6	6.5	6.8	4.8	2.0	9.4							" " - TRY DBL. 9x7
4	DBL. 9x7	"	83	0.4	3.6	6.0	6.5	4.8	2.0	8.1							CLOSE TO AHW - CHECK BEVELED EDGE
5	DBL. 9x7	BEVELED	83 4.5	0.2	3.0	6.0	6.5	4.8	2.0	7.5							LOWERED HW ₀ 0.6 - TRY DBL. 10x7
6	DBL. 10x7	"	75 4.0	0.2	2.3	5.5	6.25	4.8	2.0	6.55	1.3	9.1	9.1	11			H _f EXCEEDS AHW - TRY SIDE TAPERED

(a) Entrance loss coefficient, Refer to Table 4-10, page 4-60.
(b) "d_c" cannot exceed D.
(c) h₀ = $\frac{D}{4}$ or TW, whichever is larger.
(d) TW = d_n in natural channel, or other downstream control.
(e) HW₀ = H + H₀ - LS
(f) Use Chart 4-7, page 4-64, for Conventional f
Use Chart 4-8, page 4-65, for Beveled Edge.

Table 900.3

Source: Arkansas Highway and Transportation Department Drainage Manual

FORM HYD 4-2
 PROJECT Example No. 2 IMPROVED INLET FOR R.C. BOX CULVERTS
 DESIGNER HVD
 DATE: 11-11-81

INITIAL DATA
 Q₂₅ = 1500 cfs S₀ 0.02
 AHW EL. 300 ft. L = 100 ft.
 El. Stream bed at face 292.0 ft.
 Allowable Headwater 8.0 ft.
 TAPER = 4 (4:1 to 6:1)
 S_f = 1 (2:1 to 3:1)
 Barrel Shape and Material R.C.B.
 Inlet Edge Description BEVELED
 N_s 2 B_f 10 ft. D_f 7 ft.

SNETCH
 Face El. 301.0
 HW_f El. 300
 AHW = H_f 0.40
 L₁ 0.21
 El. 292.0
 291.62 El. 291.3
 291.62 El. 291.3
 ELEVATION
 PLAN
 SIDE - TAPERED
 SLOPE - TAPERED (Vertical Face)
 ELEVATION
 PLAN

SELECTED DESIGN
 B_f = 30.0 ft. L₃ = — ft.
 L₂ = — ft. L₁ 20.0 ft.
 Bevels: Angle 30°
 d = 7 in.
 TAPER 4:1
 S_f = —
 S = — ft./ft.

SIDE TAPERED (n)										SLOPE TAPERED (D/4 ≤ Fall ≤ 1.5 D)										COMMENTS
H _f (a)	D (b)	S ₀ (c)	Min B _f (d)	L ₁ (e)	S (f)	Elev Face Invert (g)	H _t (h)	Elev Throat Invert (i)	H _f /D (j)	D (k)	Min B _f (l)	Min L ₃ (m)	L ₂ (n)	Check L ₂ (o)	Adj L ₃ (p)	Adj Taper (q)	L ₁ (r)			
1	2	3	4	5	6	7	8	9	10	11	12	13	14	15	16	17	18	19	20	
1.0	2.4	18.5	34.0	28.0	0.025															
1.1	2.7	18.5	30.0	20.0	0.016	292.0	4.0	8.4	291.6	—										
NOTE: MIN. B _f SHOWN IN COLUMN 4 DOES NOT INCLUDE DIVISION WALL																				

(a) $H_{f/D} = (HW_f - \text{Throat Invert Elev.} - 1)/D$ (e) Use Chart 4-10, page 4-67. (k) If Column 16 > 15, Adjust $L_3 = \frac{B_f - NB}{2}$ TAPER = L_2
 (b) Use Chart 4-9, page 4-66. (f) $H_{f/D} = (HW_f - \text{Face Invert Elev.})/D$ (l) If Column 15 > 16, Adjust TAPER = $(L_2 + L_3) / \frac{B_f - NB}{2}$
 (c) $Min B_f = \frac{Q}{(D \frac{S_0}{2})^{0.5}}$ (g) Use Chart 4-11, page 4-68. (m) $L_1 = L_2 + L_3$
 (d) $L_1 = \frac{H_f - 1.0}{S_f}$ (TAPER) (h) $Min L_3 = 0.5 NB$ (n) Elev. Face Invert - Elev. Throat Invert ≤ 1 ft.
 (i) $L_2 = (\text{Elev. Face Invert} - \text{Elev. Throat Invert}) / S_f$ (o) Check $L_2 = \frac{B_f - NB}{2}$ TAPER = L_3

Table 900.4

Source: Arkansas Highway and Transportation Department Drainage Manual

900.8.5 Example Problem No. 3

GIVEN: Design Discharge (Q₅₀) = 1,000 cfs
 Slope of stream BPWD (S₀) = 0.175 ft. / ft.
 Allowable headwater elevation = 200.0
 Elevation outlet invert = 172.5
 Culvert length (L) = 100 ft.

Downstream channel approximates a 12 ft. wide trapezoidal channel with 2:1 slopes, Manning “n” of 0.03 and a slope (S₀) of 0.175 feet per foot.

REQUIRED:

Design a culvert that will adequately convey the design discharge. The culvert should have the smallest possible barrel to pass design Q without exceeding AHW elevation. Try a reinforced concrete box culvert with “n” = 0.012.

SOLUTION:

Use procedures as outlined in STEPS 1 through 5 of Example Problem No. 1.

COMPUTATIONS:

See Table 900.5 and 900.6, respectively for detailed computations.

CONCLUSION – EXAMPLE PROBLEM NO. 3

The selected design for the smallest barrel section is a 6' x 6' R.C. box culvert.

All improved inlet types were reviewed for discharge and AHW requirements. An on site inspection and structure type economics should be considered by the designer as parameters for the hydraulic decision.

The existing stream BPWD slope is steep (0.175 ft. / ft.). The side-tapered inlet must have FALL upstream of the inlet face. If this is not permissible, then the designer should omit the computations for the side-tapered inlet and check the slope-tapered inlet, which incorporates a BPWD within the barrel. Headwater control will be at the throat instead of the face.

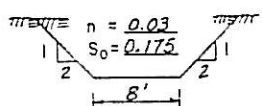
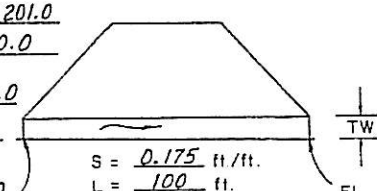
FORM HYD 4-1		CULVERT COMPUTATIONS (SQUARE AND BEVELED EDGES)										DESIGNER: <u>HYD</u>					
PROJECT: <u>Example No.3</u>												DATE: <u>11-11-81</u>					
HYDROLOGIC AND CHANNEL INFORMATION										SKETCH							
HYDROLOGY					STREAM DATA					STATION: <u>400+00</u>							
Q_1 <u>50</u> = <u>1000</u> cfs Q_2 _____ = _____ cfs _____ cfs					TW_1 = <u>4.6</u> TW_2 = _____ n = <u>0.03</u> S_0 = <u>0.175</u> 					FIN. GR. EL. <u>201.0</u> HW _f EL. <u>200.0</u> AHW = <u>10.0</u> (H _f) H _f EL. <u>190.0</u> S = <u>0.175</u> ft./ft. L = <u>100</u> ft. EL. <u>172.5</u> 							
OUTLET CHANNEL (APPROX. DIMENSIONS)																	
TRIAL NO.	SIZE	STRUCTURE TYPE & ENTRANCE DESIGN	Q / NB	HEADWATER COMPUTATION								INLET CONT.	CONTROL-LING HW	OUTLET VELOCITY ft./sec.	COST	COMMENTS	
				(a) K _e	(b) H	(c) d _c	(d) h ₀	(e) TW	(f) LS	(g) HW ₀	(h) HW / D						
0	1	2	3	4	5	6	7	8	9	10	11	12	13	14	15	16	
1 (Q1)	7x6	SQ. EDGE	143	0.4	14.6	> 6	6	4.6	17.5	3.1						6.9' LOWER THAN AHW TRY 6x6	
2 (Q1)	6x6	"	167	0.4	20.0	> 6	6	4.6	17.5	8.5						CLOSE TO AHW CHECK 5x6	
3 (Q1)	5x6	"	200	0.4	29.0	> 6	6	4.6	17.5	17.5						EXCEEDS AHW - CHECK 6x6 BEVELED EDGE	
4 (Q1)	6x6	BEVELED	$\frac{10^3}{11.3}$	0.2	18.0	> 6	6	4.6	17.5	6.5	4.1 ±	24.6	24.6	28		LOWERED HW ₀ 2.0; H _f > AHW - TRY SIDE TAPERED	

(a) Entrance loss coefficient, Refer to Table 4-10, page 4-60.
 (b) "d_c" cannot exceed D.
 (c) $h_0 = \frac{d_c + D}{2}$ or TW, whichever is larger.
 (d) TW = d_n in natural channel, or other downstream control.
 (e) HW₀ = H + H₀ - LS
 (f) Use Chart 4-7, page 4-64, for Conventional face.
 Use Chart 4-8, page 4-65, for Beveled Edge.

Table 900.5

Source: Arkansas Highway and Transportation Department Drainage Manual

FORM HYD 4-2
 PROJECT Example No. 5
 IMPROVED INLET FOR R.C. BOX CULVERTS
 DESIGNER HYD
 DATE 11-11-01

INITIAL DATA
 Q 50 = 1000 cfs $S_o = 0.175$
 AHW EL. 200 ft. L = 100 ft.
 El. Stream bed at face 190.0 ft.
 Allowable Headwater 10.0 ft.
 TAPER = 4 (4:1 to 6:1)
 $S_f = 2$ (2:1 to 3:1)
 Barrel Shape and Material R.C.B.
 Inlet Edge Description BEVELED
 $N = 1$, $B = 6$ ft., $D = 6$ ft.

SKETCH

SELECTED DESIGN
 $D_1 = 14$ ft. $L_3 = 3$ ft.
 $L_2 = 19$ ft. $L_1 = 22$ ft.
 Batters: Angle 30°
 $d = 6$ in.
 TAPER 5.5:1
 $S_f = 2$
 $S = 0.103$ ft/ft

SIDE TAPERED (n)										SLOPE TAPERED (D/4 ≤ Fall ≤ 1.5 D)										COMMENTS
H _f (a)	Q (b)	D (c)	Min B _f (d)	L ₁ (e)	S (f)	Elev. Face Invert (g)	Q (h)	H _f (i)	Elev. Throat Invert (j)	H _f /D (k)	Q (l)	Min B _f (m)	Min L ₃ (n)	L ₂ (o)	Check L ₂ (p)	Adj. L ₃ (q)	Adj. Taper (r)	L ₁ (s)		
1.67	4.6	14.7	15.0	18.0	0.05	190.0	11.3	19.5	180.5	1.67	5.0	14.0	3.0	19.0	13.0	—	5.5:1	22.0	USE	

(a) $H_{fD} = (HW_f - \text{Throat Invert Elev.} - 1)/D$
 (b) Use Chart 4-9, page 4-66.
 (c) $\text{Min } B_f = \frac{Q}{(D^{3/2}) \cdot S_f}$
 (d) $L_1 = \frac{B_f \cdot H_f}{2}$ TAPER!
 (e) Use Chart 4-10, page 4-67.
 (f) $H_{fD} = (HW_f - \text{Face Invert Elev.})/D$
 (g) Use Chart 4-11, page 4-68.
 (h) $\text{Min } L_3 = 0.5 \text{ NB}$
 (i) $L_2 = (\text{Elev. Face Invert} - \text{Elev. Throat Invert}) \cdot S_f$
 (j) Check $L_2 = \frac{B_f \cdot H_f}{2}$ TAPER
 (k) If Column 16 > 15, Adjust $L_3 = \frac{B_f \cdot H_f}{2}$ TAPER - L_2
 (l) If Column 15 > 16, Adjust TAPER = $(L_2 + L_3) / \frac{B_f \cdot H_f}{2}$
 (m) $L_1 = L_2 + L_3$
 (n) Elev. Face Invert - Elev. Throat Invert ≤ 1 ft.

Table 900.6

Source: Arkansas Highway and Transportation Department Drainage Manual

Table 900.7

FORM HYD 4-1
 PROJECT _____
 CULVERT COMPUTATIONS (SQUARE AND BEVELED EDGES)
 DESIGNER: _____
 DATE: _____

HYDROLOGIC AND CHANNEL INFORMATION

HYDROLOGY
 $Q_1 = \text{_____ cfs}$
 $Q_2 = \text{_____ cfs}$

STREAM DATA
 $TW_1 = \text{_____}$
 $TW_2 = \text{_____}$
 $n = \text{_____}$
 $S_o = \text{_____}$

OUTLET CHANNEL (APPROX DIMENSIONS)

SKETCH
 STATION _____

TRIAL NO	SIZE	STRUCTURE TYPE & ENTRANCE DESIGN	HEADWATER COMPUTATION										OUTLET VELOCITY ft./sec.	COST	COMMENTS	
			Q/NB	(a)	(b)	(c)	(d)	(e)	INLET CONT.	CONTROL	LING	HW				
0	1	2	3	4	5	6	7	8	9	10	11	12	13	14	15	16

(a) Entrance loss coefficient, Refer to Table 4-10, page 4-60.
 (b) d_c cannot exceed D.
 (c) $h_o = \frac{d_c + D}{2}$ or TW, whichever is larger.
 (d) $TW = d_n$ in natural channel, or other downstream control
 (e) $HW_o = H + H_o - LS$
 (f) Use Chart 4-7, page 4-64, for Conventional face.
 Use Chart 4-8, page 4-65, for Beveled Edge

FORM HYD 4-2
 PROJECT: _____
 IMPROVED INLET FOR R.C. BOX CULVERTS
 DESIGNER: _____
 DATE: _____

INITIAL DATA
 Q = _____ cfs S_o _____
 AHW EL. _____ ft. L = _____ ft.
 El. Stream bed at face _____ ft.
 Allowable Headwater _____ ft.
 TAPER = _____ : 1 (4:1 to 6:1)
 S_f = _____ : 1 (2:1 to 3:1)
 Barrel Shape and Material _____
 Inlet Edge Description _____
 H = _____ ft. B = _____ ft. D = _____ ft.

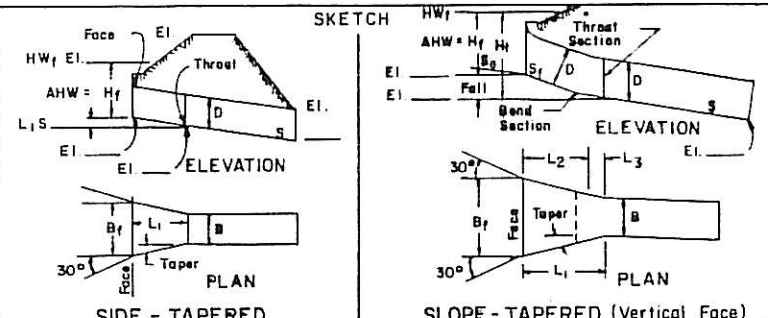
SKETCH

SELECTED DESIGN
 Bf = _____ ft. L3 = _____ ft.
 L2 = _____ ft. L1 = _____ ft.
 Bevels: Angle _____ °
 d = _____ in.
 TAPER = _____ : 1
 S_f = _____ : 1
 S = _____ ft./ft.

IMPROVED INLET															COMMENTS					
SIDE TAPERED (n)					SLOPE TAPERED ($D/4 \leq F_{all} \leq 1.5 D$)															
H_f/D	(a) $\frac{Q}{BfD^{3/2}}$	(b) $D^{3/2}$	(c) Min Bf	(d) L1	S ft./ft.	Elev Face Invert	(e) $\frac{Q}{NB D^{3/2}}$	Hf	(f) Elev Throat Invert	(g) H_f/D	(h) $\frac{Q}{BfD^{3/2}}$	(i) Min Bf	(j) Min L3	(k) L2	(l) Check L2	(m) Adj L3	(n) Adj Taper	(o) L1	(p)	
1	2	3	4	5	6	7	8	9	10	11	12	13	14	15	16	17	18	19	20	

(a) $H_f/D = (HW_f - \text{Throat Invert Elev.} - 1)/D$
 (b) Use Chart 4-9, page 4-66.
 (c) $\text{Min } Bf = \frac{Q}{(D^{3/2})^{0.75}}$
 (d) $L_1 = \frac{Bf - NB}{TAPER}$
 (e) Use Chart 4-10, page 4-67.
 (f) $H_f/D = (HW_f - \text{Face Invert Elev.})/D$
 (g) Use Chart 4-11, page 4-68.
 (h) $\text{Min } L_3 = 0.5 NB$
 (i) $L_2 = (\text{Elev. Face Invert} - \text{Elev. Throat Invert}) S_f$
 (j) Check $L_2 = \left[\frac{Bf - NB}{2} \right] TAPER$
 (k) If Column 16 > 15, Adjust $L_3 = \left[\frac{Bf - NB}{2} \right] TAPER - L_2$
 (l) If Column 15 > 16, Adjust $TAPER = (L_2 + L_3) / \left[\frac{Bf - NB}{2} \right]$
 (m) $L_1 = L_2 + L_3$
 (n) Elev. Face Invert - Elev. Throat Invert ≤ 1 ft.

Table 900.8

Source: Arkansas Highway and Transportation Department Drainage Manual

900.8.6 Design Limitations and Recommendations

1. For multibarrel installations bevels must be sized on the basis of total clear opening rather than on individual barrel size.
2. For multibarrel installations exceeding 3:1 width to depth ratio it is recommended that the side bevel be sized in proportion to the total clear width (B), or three times the height, whichever is smaller.
3. Skewed inlets should be avoided whenever possible, and should not be used with side or slope-tapered inlets.
4. 4:1 taper is recommended for side-tapered inlets.
5. Upstream fall is normally not recommended. If fall is warranted, the plane of the barrel invert from upstream FALL (depression) of side-tapered inlets should be extended upstream from the face of wingwalls a minimum distance of D/2. The designer should always consider a slope-tapered inlet structure where fall is warranted in lieu of upstream depression.

6. For double barrel structures, the face width, as determined from Exhibits 900-9 and 900-11, respectively, is the total clear face width needed. The width of the division wall must be added to this value in order to size the face correctly.
7. No design procedures are available for side-tapered and slope-tapered inlet culverts with more than two barrels.
8. The FALL slope must range from 2:1 to 3:1.
9. FALL should range from $D/4$ to $1.5D$. FALLS less than $D/4$, must be designed as side-tapered inlets.
10. DO NOT interpolate between Exhibits 900-9 and 900-11, respectively.
11. DO NOT use an “ L_3 ” value less than $0.5B$.
12. Throat control should govern in the design of all improved inlets.

900.9 OUTLET VELOCITY CONTROL

900.9.1 General

If the outlet velocity of a culvert is deemed excessive by the designer, there are possible solutions available by which velocity may be either reduced or controlled. the most widely used control has been the use of riprap which covers the channel area immediately downstream from the culvert outlet. However, there are other design possibilities available. Certain special culvert types have the chief function of maintaining acceptable outlet velocities which would be excessive if a straight profile culvert were used. One such special culvert type is the broken-back culvert.

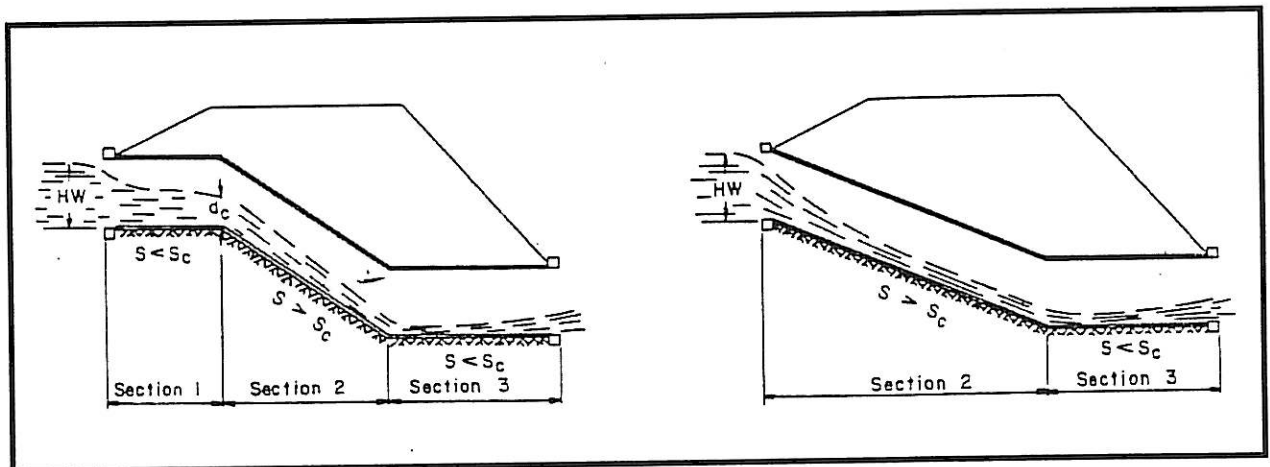

Figure 900.12

Figure 900.13

Source: Arkansas Highway and Transportation Department Drainage Manual

It is recommended that Section 1 either not be used or be very short. This allows for more adjustment in the profiles of Section 2 and Section 3.

900.9.2 Velocity Control Devices

900.9.2.1 Broken-Back Culvert Design

The designer may occasionally encounter culvert locations at which the difference in elevation from one side of the highway to the other is so great as to cause outlet velocities which are unacceptably high. In this event, the engineer may choose to design a broken-back culvert as depicted in Figures 900.12 or 900.13. The advantage of a broken-back culvert towards reducing outlet velocities lies in the theory of the hydraulic jump.

The broken-back culvert employs the hydraulic jump as an energy dissipater (or velocity reducer). But the formation of the jump requires that:

- a. there be sufficient natural tailwater greater than critical depth of culvert (not usually the case since the broken-back culvert is usually located on a steep profile such as a hillside and stream depth is rather shallow).
- b. there be sufficient friction in Section 3 (see Figures 900.12 and 900.13. This is possible only if the culvert material is very rough and/or the Section 3 length is relatively long. Normally, in a broken-back culvert, neither of the above circumstances exist. It is therefore necessary to employ special energy dissipater devices to assist in forming the hydraulic jump and reduce velocities.

The hydraulic jump is a feature in hydraulic flow by which flow in a super-critical condition abruptly changes to flow in a subcritical condition. In other words, a given discharge traveling at some depth less than critical depth and some velocity greater than critical velocity, upon passing through a hydraulic jump, then flows at some depth greater than critical depth and some velocity less than critical velocity.

The design of a broken-back culvert is not particularly difficult but certain provisions must be made or circumstances found so that the primary intent of reducing velocity at the outlet is realized. The design and the provisions or circumstances are discussed as follows:

1. Initial Information Needed:
 - a. Upstream channel or culvert slope, width, Q and roughness factor.
 - b. Downstream slope, width, Q (constant), and roughness factor.
 - c. Tailwater
2. Data to be calculated for analysis:
 - a. Normal depth (d_{n1}) and velocity (V_1) of upstream section.
 - b. Normal depth (d_{n2}) and velocity (V_2) of upstream section.
 - c. Calculate the Froude Number (F_1) for the upstream section.

$$F_1 = \frac{V_1}{\sqrt{g d_{N1}}} \approx 0.5$$

- d. Determine the ratio of the downstream normal depth to the upstream normal depth. i.e. d_{n2} / d_{n1}
3. Hydraulic Jump Determination
 - a. If $F_1 > 2.0$ and $d_{n2} / d_{n1} > 2.4$, then a jump is indicated
 - b. If $F_1 > 1.7$ and $d_{n2} / d_{n1} > 2.0$, then a jump is not indicated
 - c. If $F_1 > 1.0$, then a jump is not possible
 - d. A hydraulic jump in horizontal rectangular channels will form if the Froude Number F_1 of the flow, the flow depth d_{n1} , and a downstream depth d_{n2} satisfy the equation $d_{n2} / d_{n1} = 0.5 (1 + 8F_1^2)^{0.5} - 1$. This equation may be represented by the curve on Exhibit 900-1.
 4. CALCULATION OF LENGTH OF HYDRAULIC JUMP is graphically shown on Exhibit 900-2, or may be estimated from the following equations:
 - a. If $2.0 < F_1 < 5.5$, then the approximate length of jump is equal to the Froude Number times the downstream normal depth.
 - b. If $F_1 > 5.5$, then the approximate length of jump is equal to the downstream normal depth times 5.75.

Equations: Length (L) = $F_1 d_{n2}$ (a)
 Length (L) = $5.75 d_{n2}$ (b)

EXAMPLE PROBLEM:

Given: Type of Structure – 4' x 4' RCB
 Upstream conditions – Slope = 15%
 n = 0.12
 Width = 4.0 feet
 Q = 150 cfs

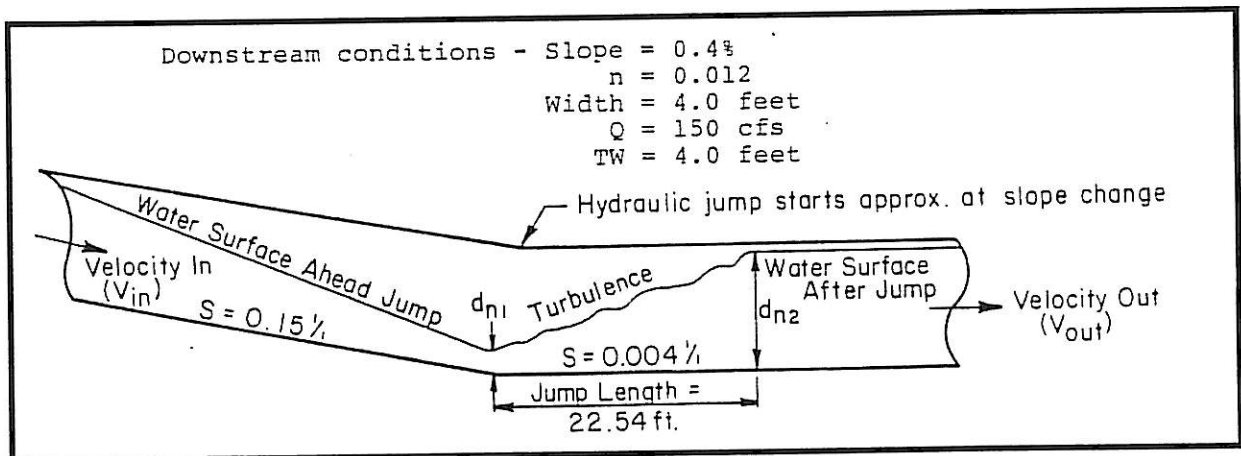

Figure 900.14

Source: Arkansas Highway and Transportation Department Drainage Manual
 TYPICAL CROSS – SECTION & PROFILE

Calculate normal depth for 150 CFS for upstream and down stream flow.

Determine normal depth and velocity for upstream section:

$$\begin{aligned}d_{n1} &= \text{from Exhibit 900-26, using 150 CFS and slope of 15\%} \\d_{n1} &= 1.0 \text{ feet}^* \\V_1 &= 150 \text{ cfs}/1.0 \text{ feet (4.0 feet)} \\V_1 &= 37.5 \text{ fps}\end{aligned}$$

* This depth is a conservative estimate of the water depth at the break in profile between sections 2 and 3. Actual depth is probably slightly more than normal depth for ordinary conditions .

Determine normal depth and velocity for downstream section:

$$\begin{aligned}d_{n2} &= \text{from Exhibit 900-26, using 150 cfs and slope of 0.4\%} \\d_{n2} &= 3.9 \text{ feet (must be } \leq \text{ TW)} \\V_2 &= 150 \text{ cfs}/3.9 \text{ feet (4.0 feet)} \\V_2 &= 9.6 \text{ fps}\end{aligned}$$

CALCULATE FROUDE NUMBER FOR UPSTREAM SECTION

$$\begin{aligned}F_1 &= 37.5 \text{ fps}/[(32.2 \text{ ft/sec/sec/}) (1.0 \text{ ft.})]^{1/2} \\F_1 &= 6.6\end{aligned}$$

CALCULATE THE RATIO OF DOWNSTREAM NORMAL DEPTH TO UPSTREAM NORMAL DEPTH

$$\begin{aligned}d_{n2}/d_{n1} &= 3.9 \text{ ft.}/1.0 \text{ ft.} \\d_{n2}/d_{n1} &= 3.9\end{aligned}$$

DETERMINE IF JUMP IS PRESENT

Is F_1 greater than 2.0?	Yes, $6.6 > 2.0$
Is F_1 greater than 5.5?	Yes, $6.6 > 5.5$
Is d_{n2}/d_{n1} ratio greater than 2.4?	Yes, $3.9 > 2.4$
All requirements are met, therefore, jump is present.	

DETERMINE THE LENGTH OF THE HYDRAULIC JUMP

Since the Froude Number for the upstream section is greater than 5.5, the number 2 equation should be used to calculate the jump length.

$$\begin{aligned}\text{Equation Number 2: Length (L)} &= 5.75 d_{n2} \\L &= 5.75 (3.9 \text{ feet}) \\L &= 22.4 \text{ feet}\end{aligned}$$

Refer to Figure 900.14 for a pictorial sketch of example problem.

900.9.2.2 RipRap

Riprap, when used as an outlet velocity control measure, should be applied to the channel area immediately downstream of the culvert outlet for a distance of no less than 20 feet or to the ROW, whichever is less. This arbitrary limit may be tempered by engineering judgement based on the severity of the velocity and the potential for erosion or scour. Most of the various types of riprap have proven effective as erosion and scour preventatives and soil protectors. (Also, see Section 1100, "Sediment and Erosion Control".

Table 900.9

MANNINGS n FOR NATURAL STREAM CHANNELS
(Surface width of flood stage less than 100 ft.)

- | | | |
|----|---|--------------|
| 1. | Fairly regular section: | |
| | a. Some grass and weeds, little or no brush | 0.030--0.035 |
| | b. Dense growth of weeds depth of flow | |
| | Materially greater than weed height..... | 0.035--0.05 |
| | c. Some weeds, light brush on banks..... | 0.035--0.05 |
| | d. Some weeds, heavy brush on banks..... | 0.05--0.07 |
| | e. Some weeds, dense willows on banks..... | 0.06--0.08 |
| | f. For trees within channel, with branches | |
| | submerged at high stage; increase all above | |
| | values by..... | 0.01--0.02 |
| 2. | Irregular sections, with pools, slight channel meander; | |
| | increase values given above..... | 0.01--0.02 |
| 3. | Mountain streams, no vegetation in channel, banks | |
| | usually steep, trees and brush along banks submerged | |
| | at high stage: | |
| | a. Bottom of gravel, cobbles, and few boulders..... | 0.04--0.05 |
| | b. Bottom of cobbles, with large boulders..... | 0.05--0.07 |

Table 900.10

ENTRANCE LOSS COEFFICIENTS
Outlet Control, Full or Partly Full

$$\text{Entrance head loss } H_e = K_e \frac{V^2}{2g}$$

<u>Types of Structure and Design of Entrance</u>	<u>Coefficient K_e</u>
PIPE, CONCRETE	
Projecting from fill, socket end (groove-end).....	0.2
Projecting from fill, square cut end.....	0.5
Socket end of pipe (groove-end).....	0.2
Square-edge.....	0.5
Round (Radius – 1/12D).....	0.2
Mitered to conform to fill slope.....	0.7
End-Section conforming to fill slope.....	0.5
Beveled edges, 33.7° to 45° bevels.....	0.2
Side or slope-tapered inlet.....	0.2
 PIPE, OR PIPE-ARCH, CORRUGATED METAL	
Projecting from fill (no headwall).....	0.9
Headwall or headwall and wingwalls square –edge.....	0.5
Mitered to conform to fill slope, pave or unpaved slope.....	0.7
End-Section conforming to fill slope.....	0.5
Beveled edges, 33.7° to 45° bevels.....	0.2
Side or slope-tapered inlet.....	0.2
 BOX, REINFORCED CONCRETE	
Headwall parallel embankment (no wingwalls)	
Square-edged on 3 edges.....	0.5
Rounded on 3 edges to radius of 1/12 barrel dimension, or beveled edges on 3 sides.....	0.2
Wingwalls at 30° to 75° to barrel	
Square-edges at crown.....	0.4
Crown edge rounded to radius of 1/12 barrel dimension, or beveled top edge.....	0.2
Wingwall at 10° to 25° to barrel	
Square-edged at crown.....	0.5
Wingwalls parallel (extension of sides)	
Square-edged at crown.....	0.7
Side or slope-tapered inlet.....	0.2

900.10 BRIDGE HYDRAULIC DESIGN

Bridges are required across nearly all open urban channels sooner or later and therefore, sizing the bridge openings is of paramount importance. When large culverts are used in lieu of bridges, the design approach often differs. Open channels with improperly designed bridges will either have excessive scour, or deposition, or will not be able to carry the design flow. It is beyond the scope of this manual to fully outline bridge hydraulic design.

900.10.1 Design Approach

The method of planning for bridge openings must include water surface profile and hydraulic gradient analysis of the channel for the major storm runoff. Once this hydraulic gradient is established without the bridge, the maximum reasonable effect on the channel flow by the bridge should be determined.

Scour is the result of the erosive action of running water, excavating, and carrying away material from the BPWD of banks and streams. Local scour involves the removal of material from the channel BPWD or bank and is restricted to a minor part of the width of a channel. This scour occurs around piers, abutments, spurs, and embankments and is caused by the acceleration of the flow and the development of vortex systems induced by the obstruction to the flow. It is beyond the scope of this Manual to fully outline the procedure. The FHWA publication, Evaluating Scour at Bridges, Hydraulic Engineering Circular No. 18 (HEC-18) and the Arkansas Highway and Transportation Department “Drainage Manual; Chapter 7) outlines the procedure to evaluate scour at bridges.

900.10.2 Bridge Opening Freeboard

The distance between the design flow water surface and the bottom of the bridge deck will vary from case to case. However, the debris which may be expected must receive full consideration in setting the freeboard. Freeboard may vary from several feet to minus several feet. There are no general hard and fast rules. Each case must be studied separately.

In certain unusual cases, the designer might properly choose to intentionally cause ponding upstream from bridges to reduce downstream peaks during the storms creating flow greater than the major design runoff. This is sometimes done when downstream areas are highly developed, and the upstream areas have adjacent open space and park areas next to the channel. In these cases, there normally would be no freeboard allowed between the design water surface and the bridge deck bottom.

900.11 BRIDGE HYDRAULIC ANALYSIS

Bridge waterway design usually requires determination of the amount and extent of backwater caused by an encroachment in the flood plain. The bridge-affected water surface elevations will be higher than water surface elevations for unconfined flow (natural profile). The standard step method can be used to compute the water surface profile on the basis of energy losses. The computations begin at one end of the study

reach and proceed cross section by cross section to the other end of the river. The standard step method involves the solution of the dynamic equation of gradually varied flow. This method is discussed in Open Channel Hydraulics by Chow. At bridge crossings where the flow hydraulics is more complicated, momentum and other equations may be used to compute the water surface elevation changes. The Arkansas Highway and Transportation Department “Drainage Manual; Chapter 7” is a good source for Bridge Hydrologic Analysis information.

Many computer programs are used for the computation of water surface profiles. Three widely used programs are HEC-2, HEC-RAS, and WSPRO. HEC-2, Water Surface Profiles and HEC-RAS were developed by the U.S. Army Corps of Engineers. Water Surface Profile Computations (WSPRO) was developed by the U.S. Geological Survey for the Federal Highway Administration. The use of HEC-2, HEC-RAS, or WSPRO is recommended for bridge hydraulic analysis. However, it is ordinarily required by FEMA that water surface profiles be modeled using the same program that was used when the stream was originally modeled.

900.11.1 HEC-2 Model

HEC-2, Water Surface Profiles computer program used to analyze backwater effects from bridge waterways. The methodology incorporated into HEC-2, is based on several simplifying assumptions, but the model produces satisfactory results in many applications. The assumptions are as follows: 1) steady flow; 2) gradually varied flow; 3) one-dimensional flow with correction for horizontal velocity distribution; 4) small channel slope; 5) friction slope (averaged) constant between two adjacent cross sections, and ; 6) rigid boundary conditions.

HEC-2 is intended for calculating water surface profiles for steady gradually varied flow in natural or man-made channels. Both subcritical and supercritical flow profiles can be calculated. The effects of various obstructions such as bridges, culverts, weirs, and structures in the flood plain may be considered in the computations. The computational procedure is based on the solution of the one-dimensional energy equation with energy loss due to friction evaluated with Manning’s Equation. HEC-2 is also designed for application in flood plain management and flood insurance studies to evaluate floodway encroachments. Also, capabilities are available for assessing the effects of channel improvements and levees on water surface profiles.

HEC-2 computes energy losses caused by structures such as bridges and culverts in two parts. One part consists of the losses that occur in reaches immediately upstream and downstream from the bridge where contraction and expansion of the flow is taking place. The second part consists of losses at the structure itself and is calculated with either the normal bridge method, special bridge method, or the special culvert option.

The normal bridge method handles the cross section at the bridge just as it would any river cross section with the exception that the area of the bridge below the water surface is subtracted from the total area and the wetted perimeter is increased where the water surface elevation exceeds the low chord. The normal bridge method is particularly applicable for bridges without piers, bridges under high submergence, and for low flow

through oval and arch culverts. Whenever flow crosses critical depth in a structure, the special bridge method should be used. The normal bridge method is automatically used by the computer, even though data was prepared for the special bridge method, for bridges without piers and under low flow control.

The special bridge method can be used for any bridge, but should be used for bridges with piers where low flow controls, for pressure flow, and whenever flow passes through critical depth when going through the structure. The special bridge method computes losses through the structure for low flow, weir flow and pressure flow or for any combination of these.

The culvert operation is a new feature in Version 4.5. The special culvert method is similar to the special bridge method, except that the Federal Highway Administration (FHWA) standard equations for culvert hydraulics are used to compute losses through the structure.

900.11.2 HEC-RAS Model

HEC-RAS (River Analysis System) incorporates similar computational procedures as in HEC-2 with some minor additions for modeling bridges. This program was initially released in July, 1995 and is planned to be updated with additional features in the future. HEC-RAS is capable of modeling options for pressure flow conditions. The main advantage offered by HEC-RAS is its graphical user interface, providing a more user-friendly environment for the modeler.

900.11.3 WSPRO Model

The FHWA contracted with the U.S. Geological Survey to develop a water surface profile computation program specifically oriented toward hydraulic design of stream highway crossings. WSPRO is a digital model for water surface profile computations for open-channel flow and is compatible with conventional techniques used in existing step-backwater analysis models. WSPRO incorporates several desirable features from existing models. Profile computations for free-surface flow through bridges are based on relatively recent development in bridge backwater analysis and recognize the influence of bridge geometry variations. Pressure flow situations (Girders partially or fully inundated) are computed using existing Federal Highway Administration techniques. Embankment overtopping flows, in conjunction with either free-surface or pressure flow through the bridge, can be computed. WSPRO is also capable of computing profiles at stream crossings with multiple openings (including culverts). WSPRO is equally suitable for water surface profile computations unrelated to highway design.

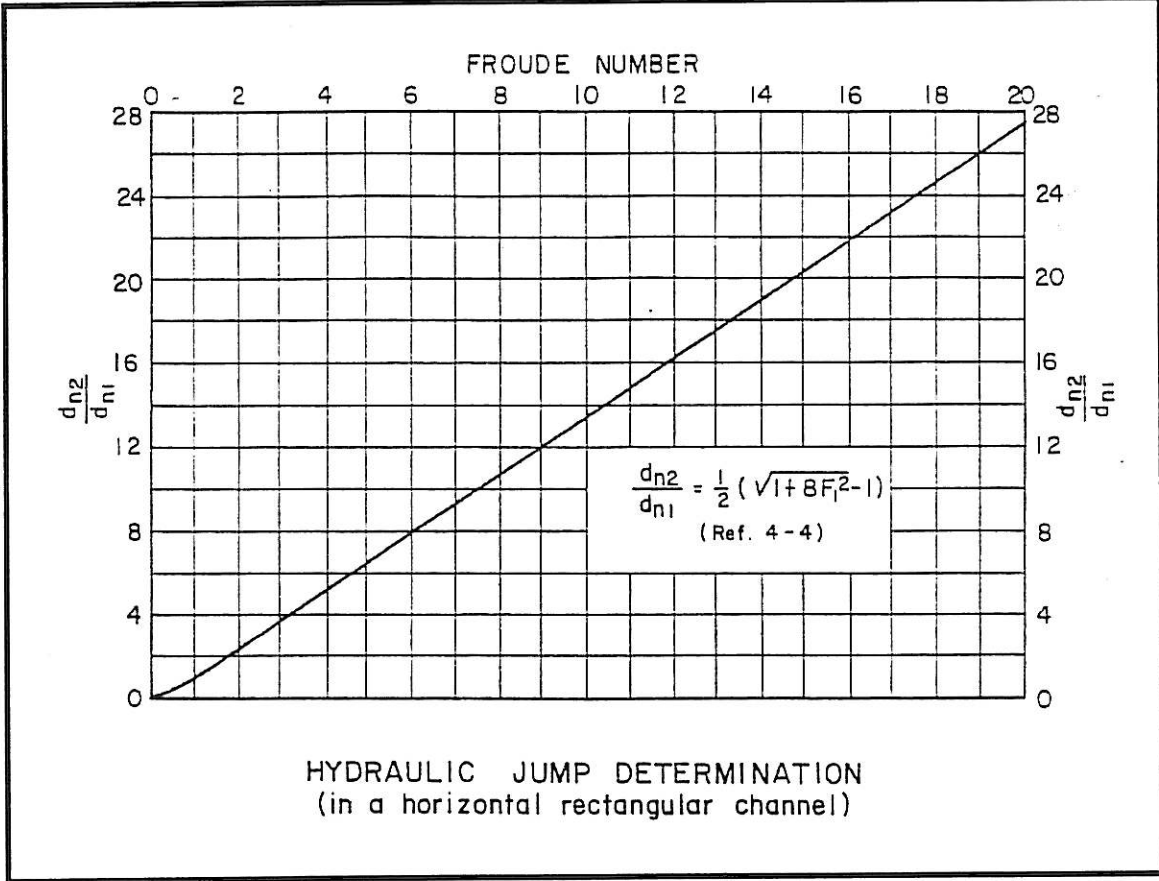

Exhibit 900-1

Source: Arkansas Highway and Transportation Department Drainage Manual

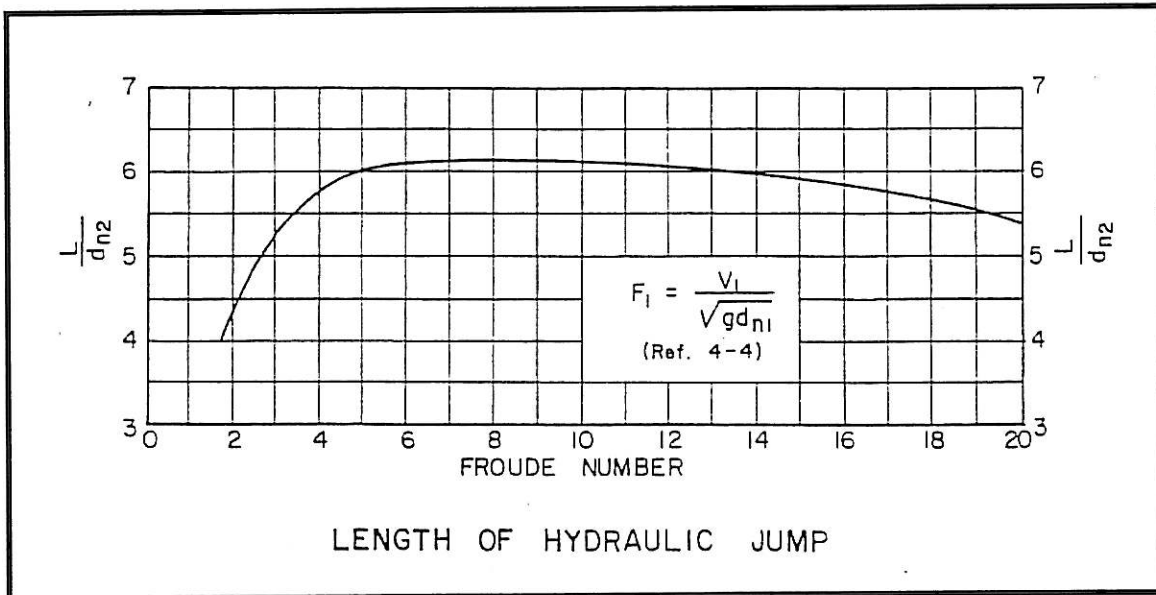

Exhibit 900-2

Source: Arkansas Highway and Transportation Department Drainage Manual

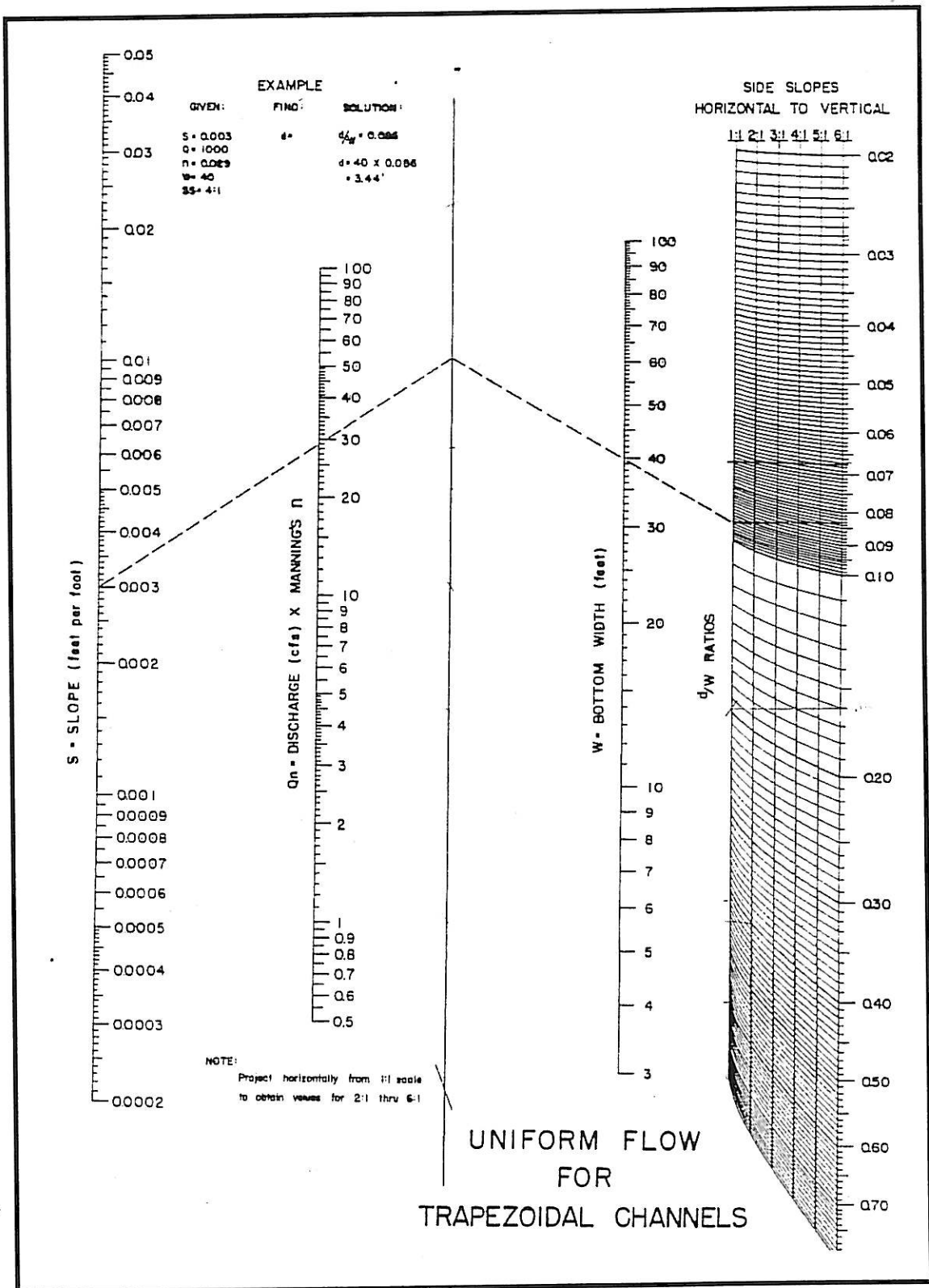

Exhibit 900-3

Source: Arkansas Highway and Transportation Department Drainage Manual

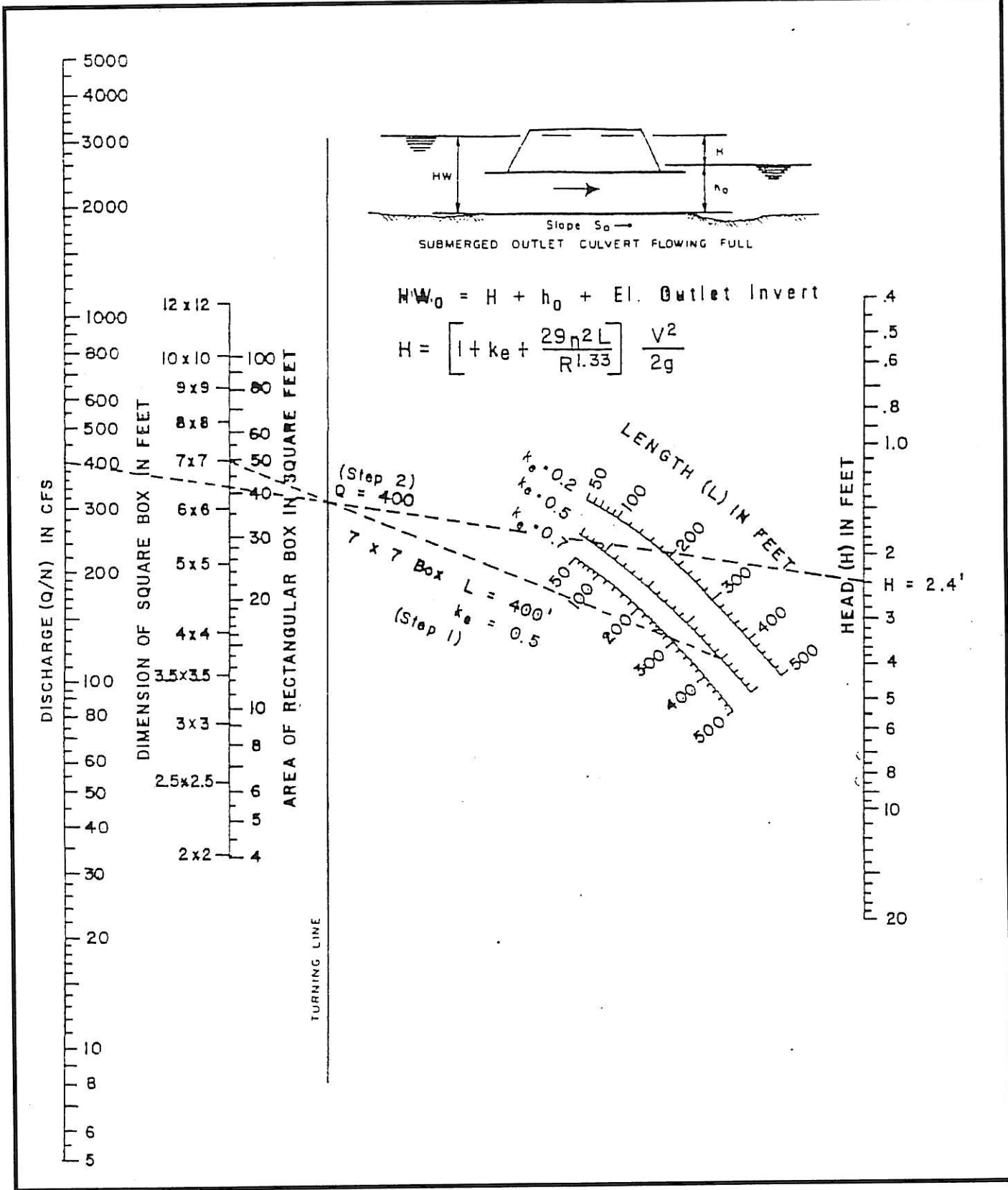

Exhibit 900-4
Head for Concrete Box Culverts Flowing Full (n = 0.012)
 Source: Arkansas Highway and Transportation Department Drainage Manual

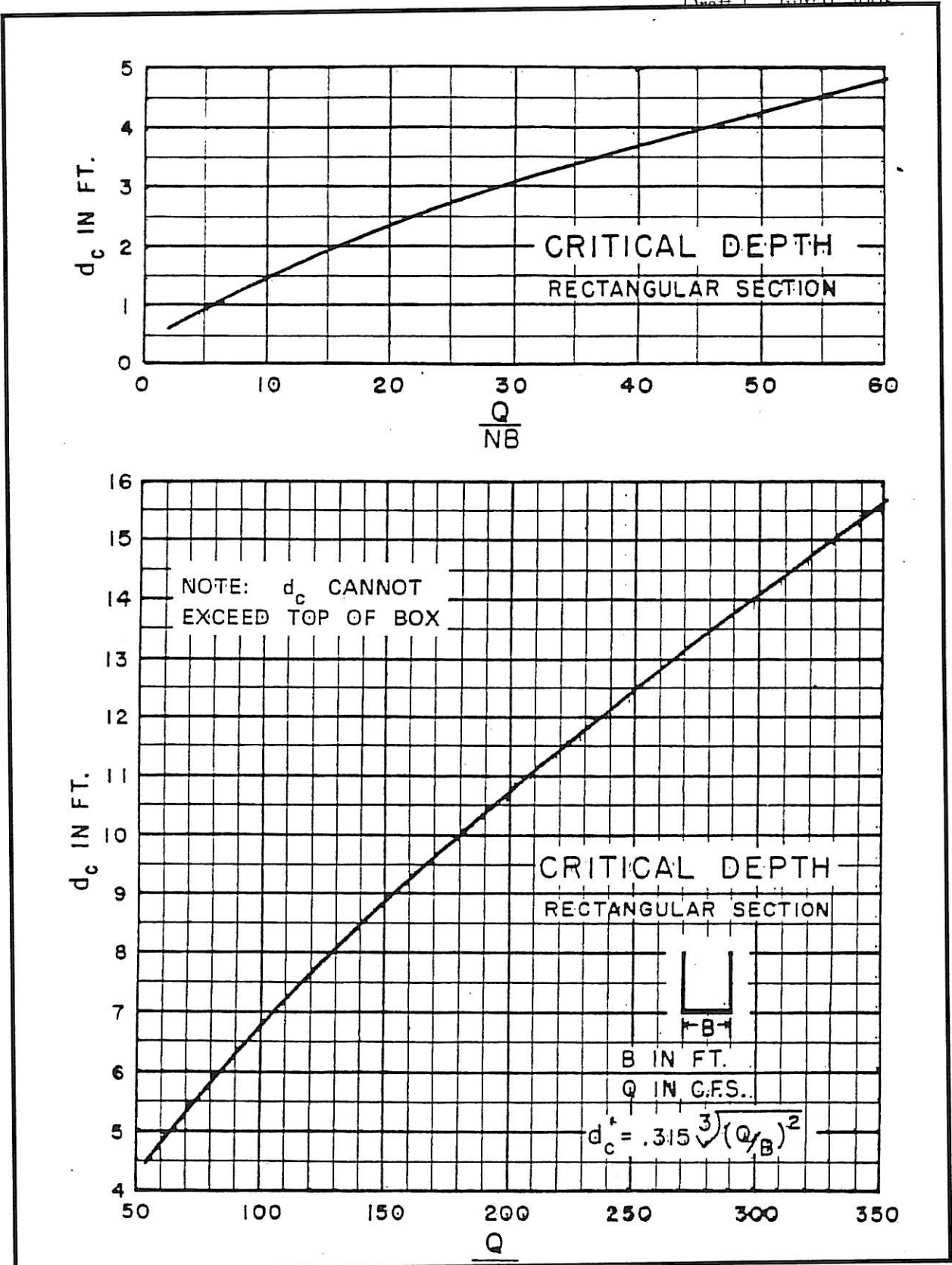
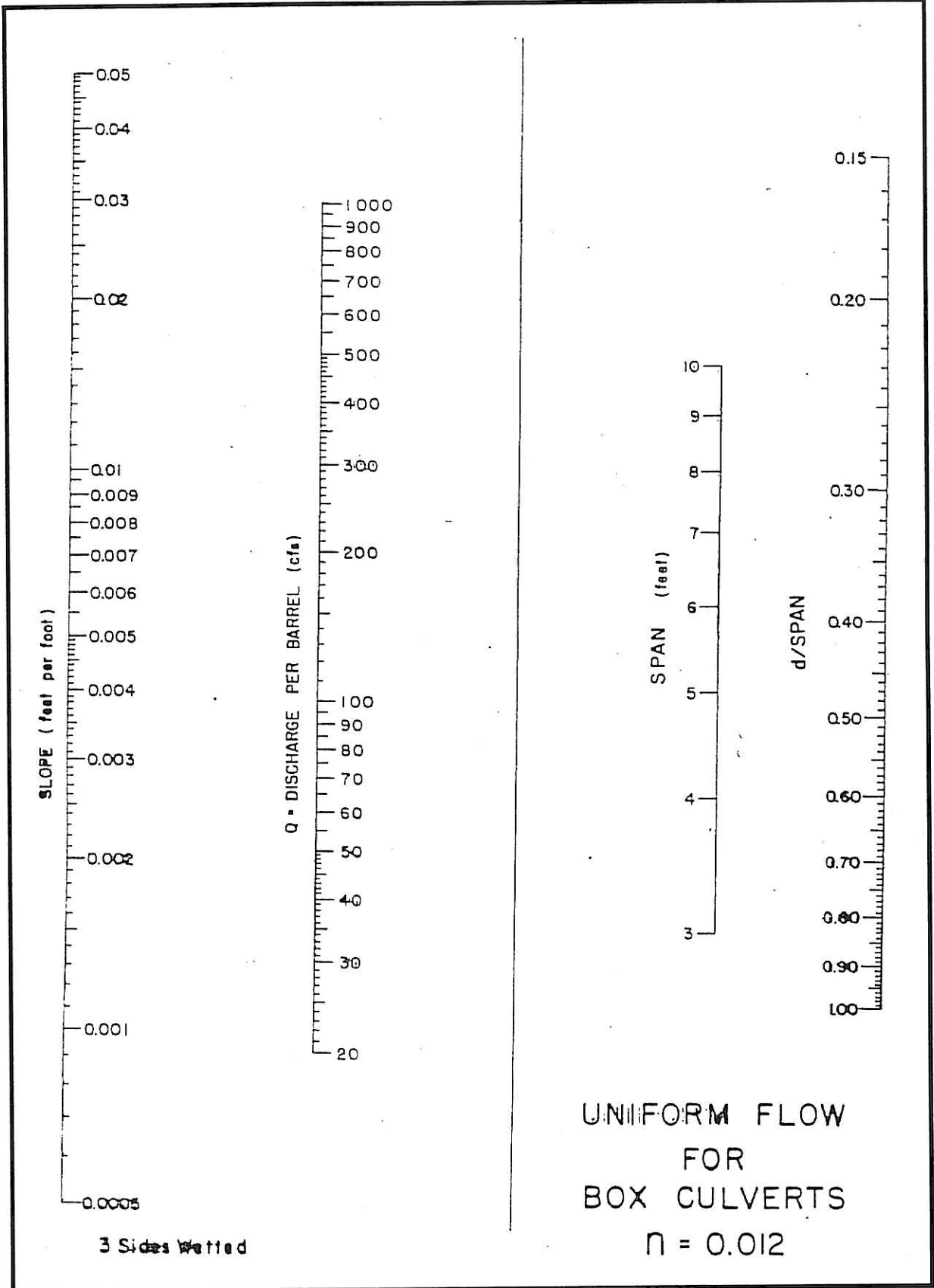

Exhibit 900-5
Critical Depth Rectangular Section
 Source: Arkansas Highway and Transportation Department Drainage Manual



3 Sides Wetted

UNIFORM FLOW
FOR
BOX CULVERTS
 $n = 0.012$

Exhibit 900-6

Uniform Flow for Box Culverts (n = 0.012)

Source: Arkansas Highway and Transportation Department Drainage Manual

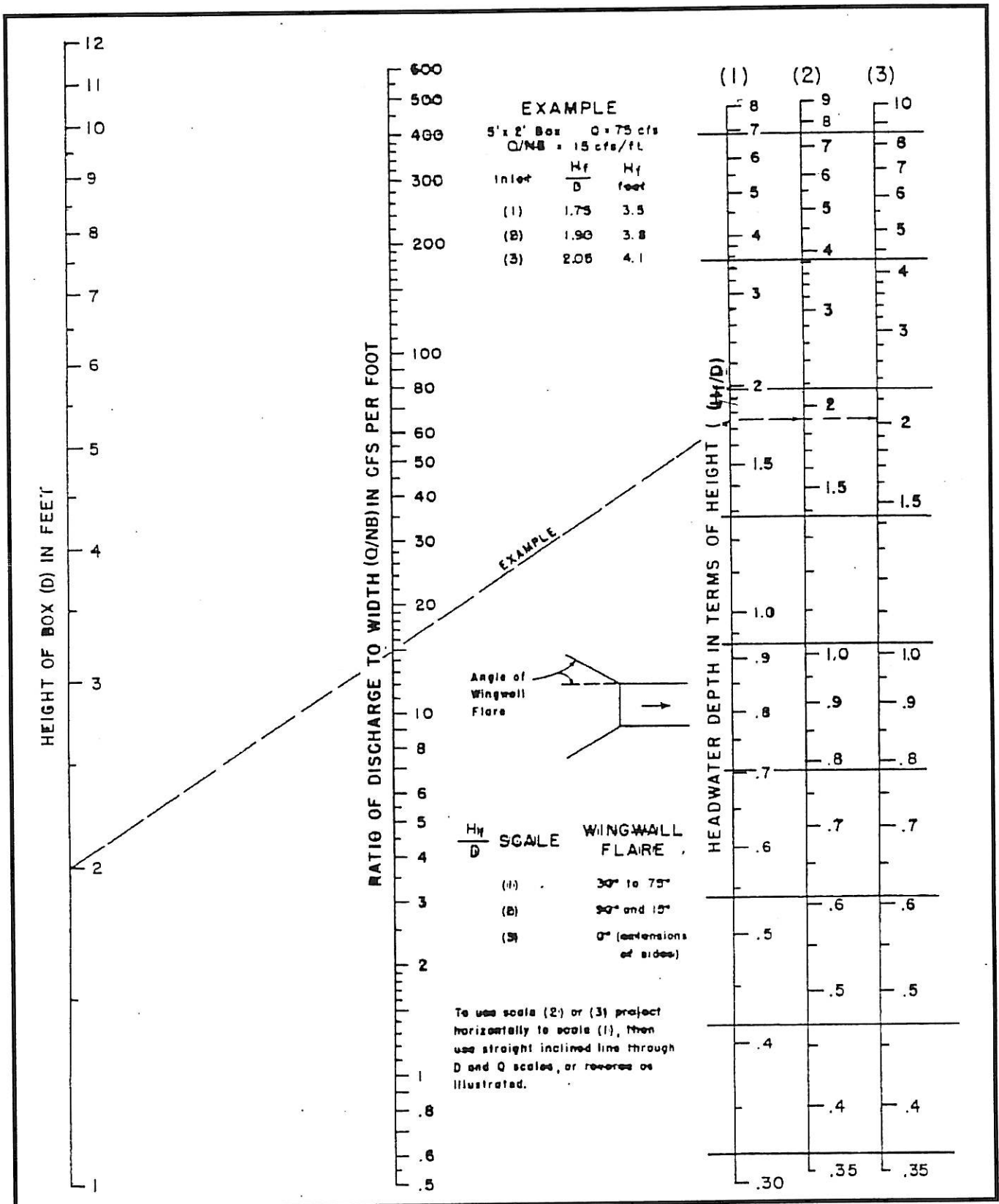

Exhibit 900-7
Headwater Depth for Box Culverts with Inlet Control
 Source: Arkansas Highway and Transportation Department Drainage Manual

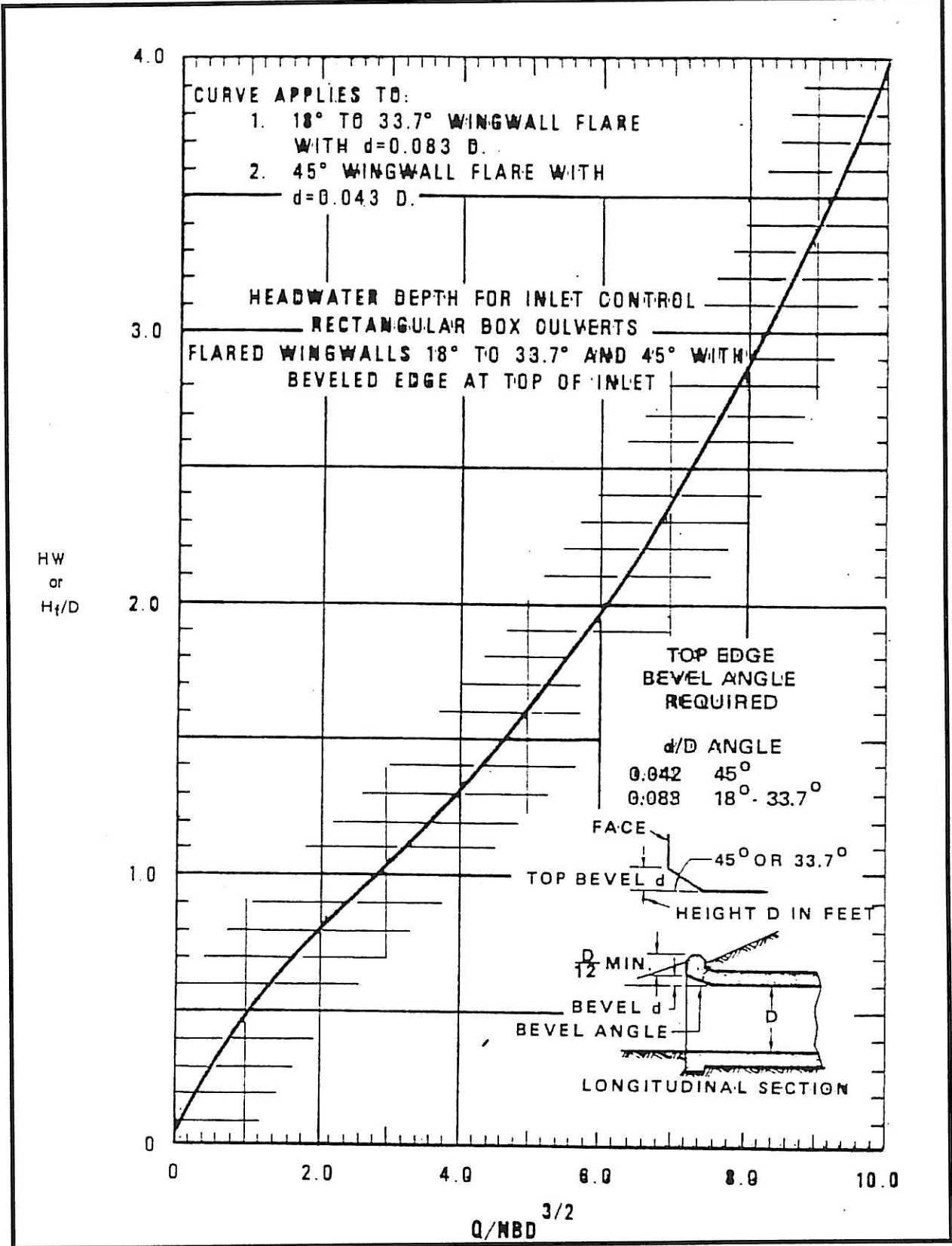
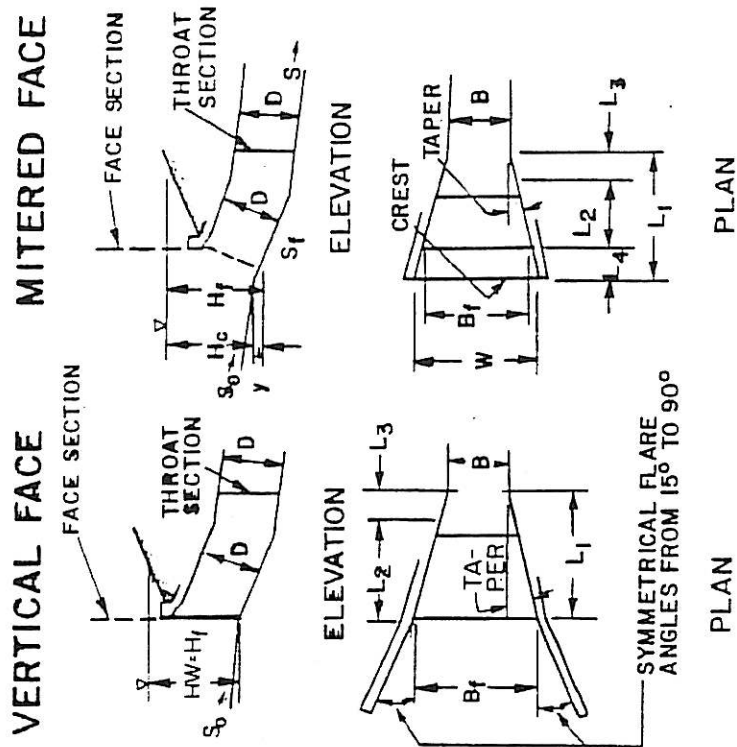
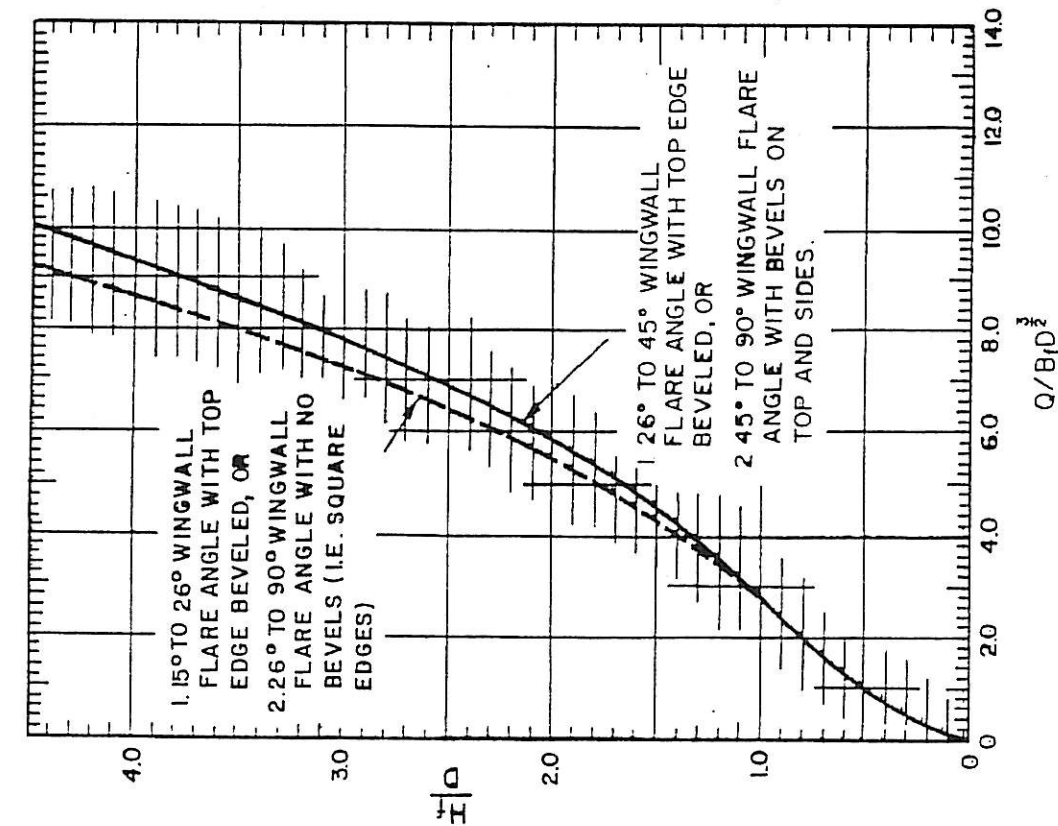

Exhibit 900-8
Headwater Depth for Inlet Control Rectangular Box Culverts
Flared Wingwalls 18° to 33.7° to 45° with Beveled Edge at Top of Inlet
 Source: Arkansas Highway and Transportation Department Drainage Manual



FACE CONTROL CURVES
FOR
BOX CULVERTS
SLOPE TAPERED INLETS

Exhibit 900-9

Face Control Curves for Box Culverts (Side Tapered Inlets)
Source: Arkansas Highway and Transportation Department Drainage Manual

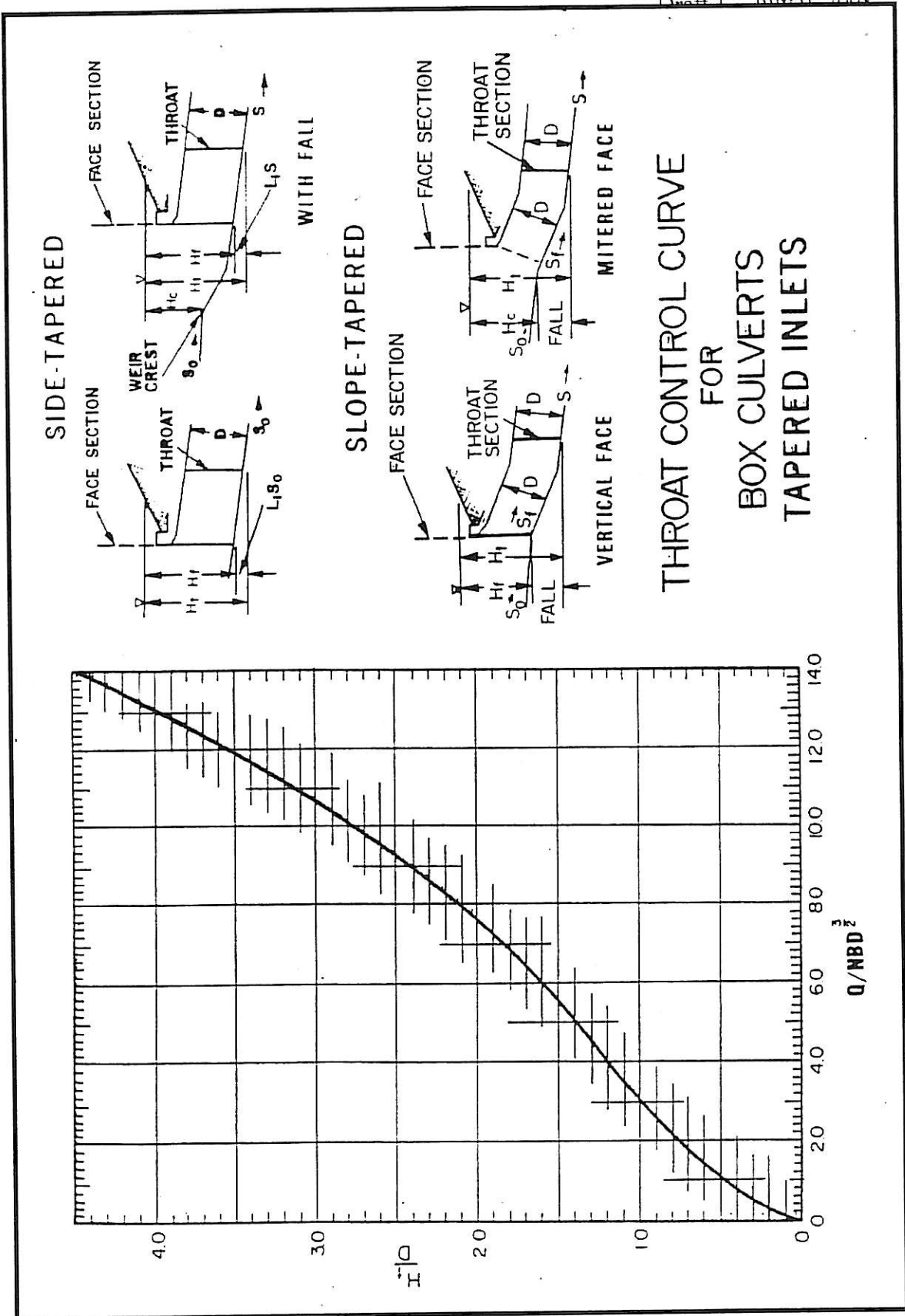

Exhibit 900-10
Throat Control Curves for Box Culverts (Tapered Inlets)
 Source: Arkansas Highway and Transportation Department Drainage Manual

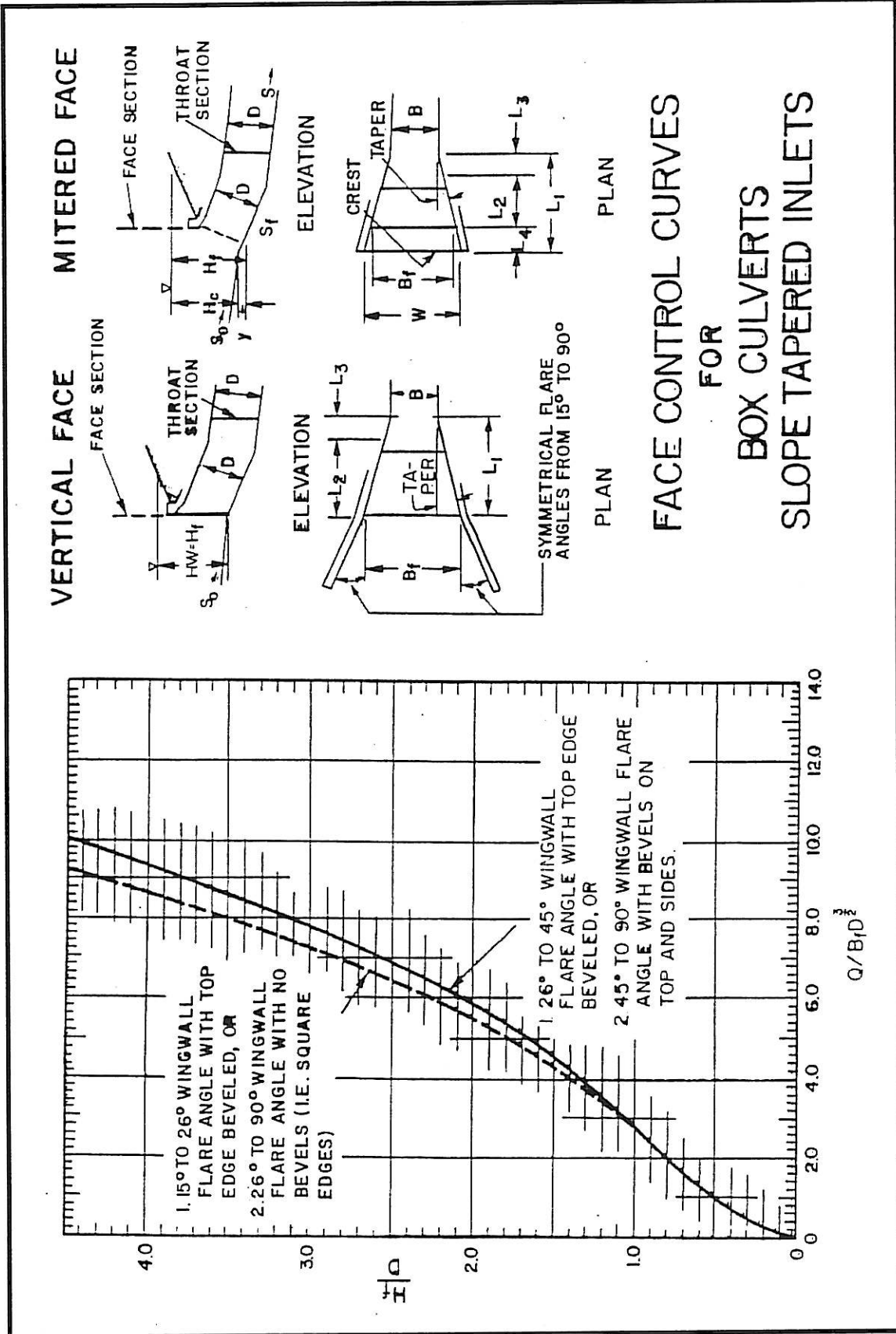

Exhibit 900-11

Face Control Curves for Box Culverts (Slope Tapered Inlets)
 Source: Arkansas Highway and Transportation Department Drainage Manual

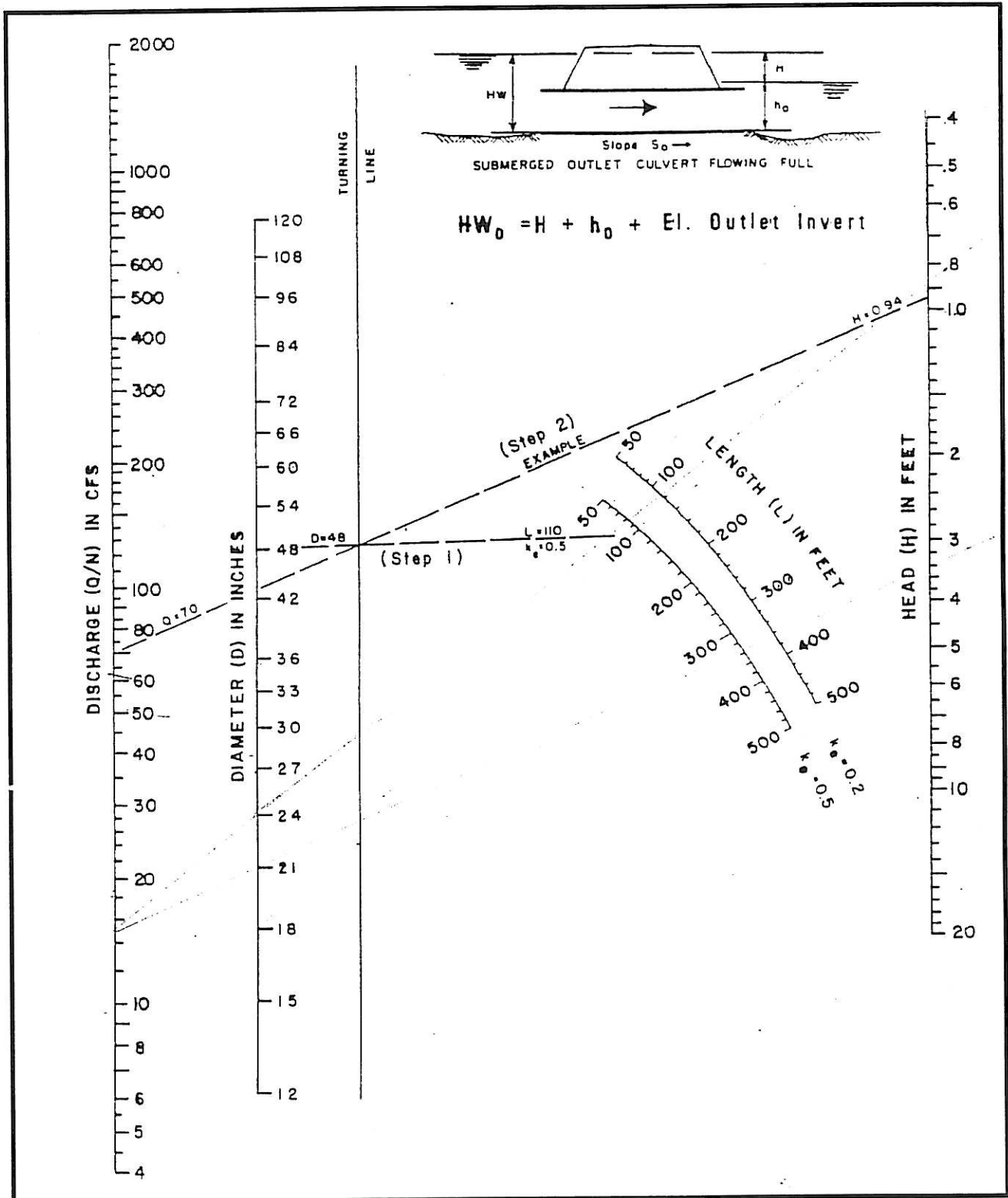

Exhibit 900-12
Head for Concrete Pipe Culverts Flowing Full (n=0.012)
 Source: Arkansas Highway and Transportation Department Drainage Manual

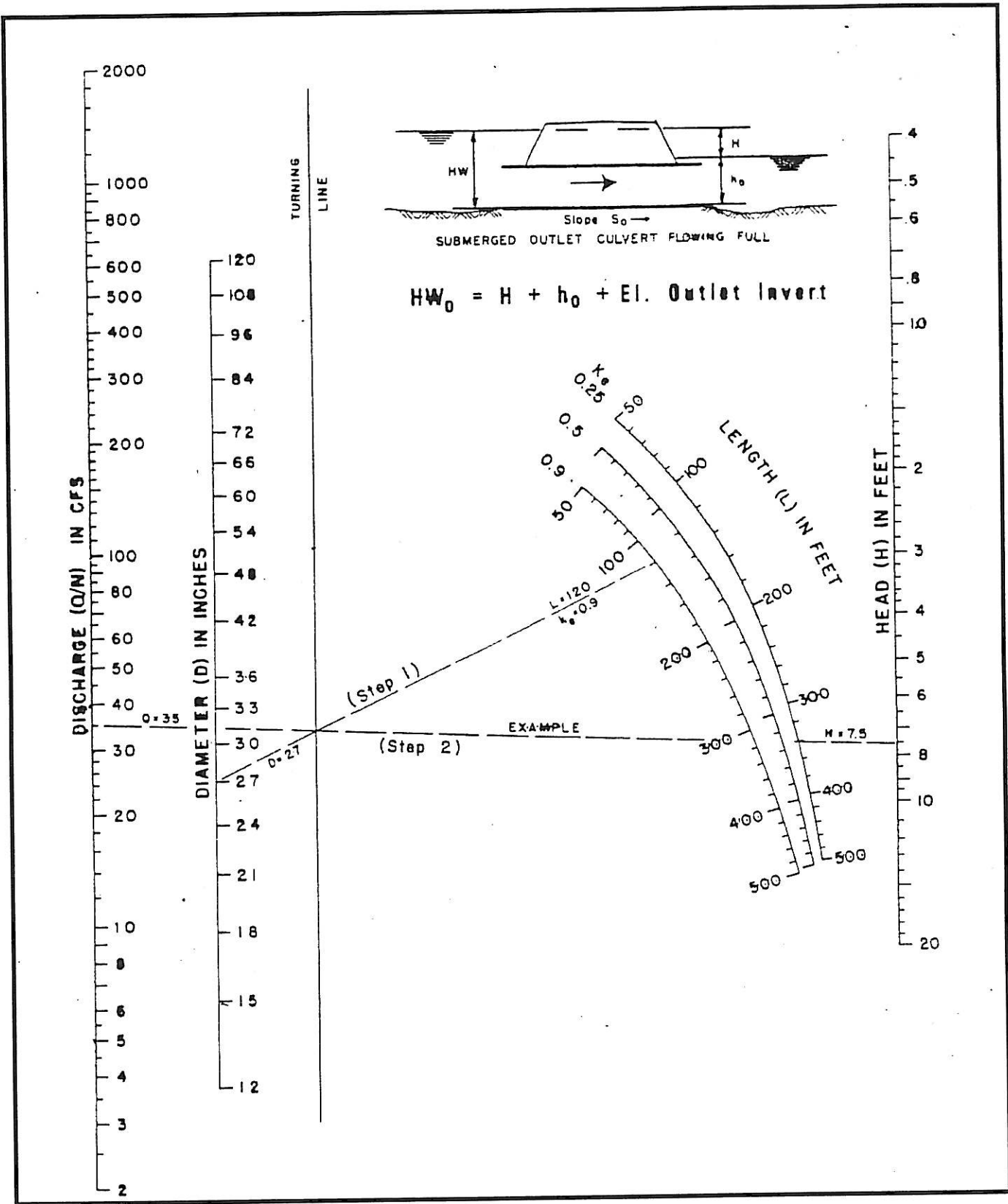

Exhibit 900-13
Head for Standard C.M. Pipe Culverts Flowing Full (n=0.024)
 Source: Arkansas Highway and Transportation Department Drainage Manual

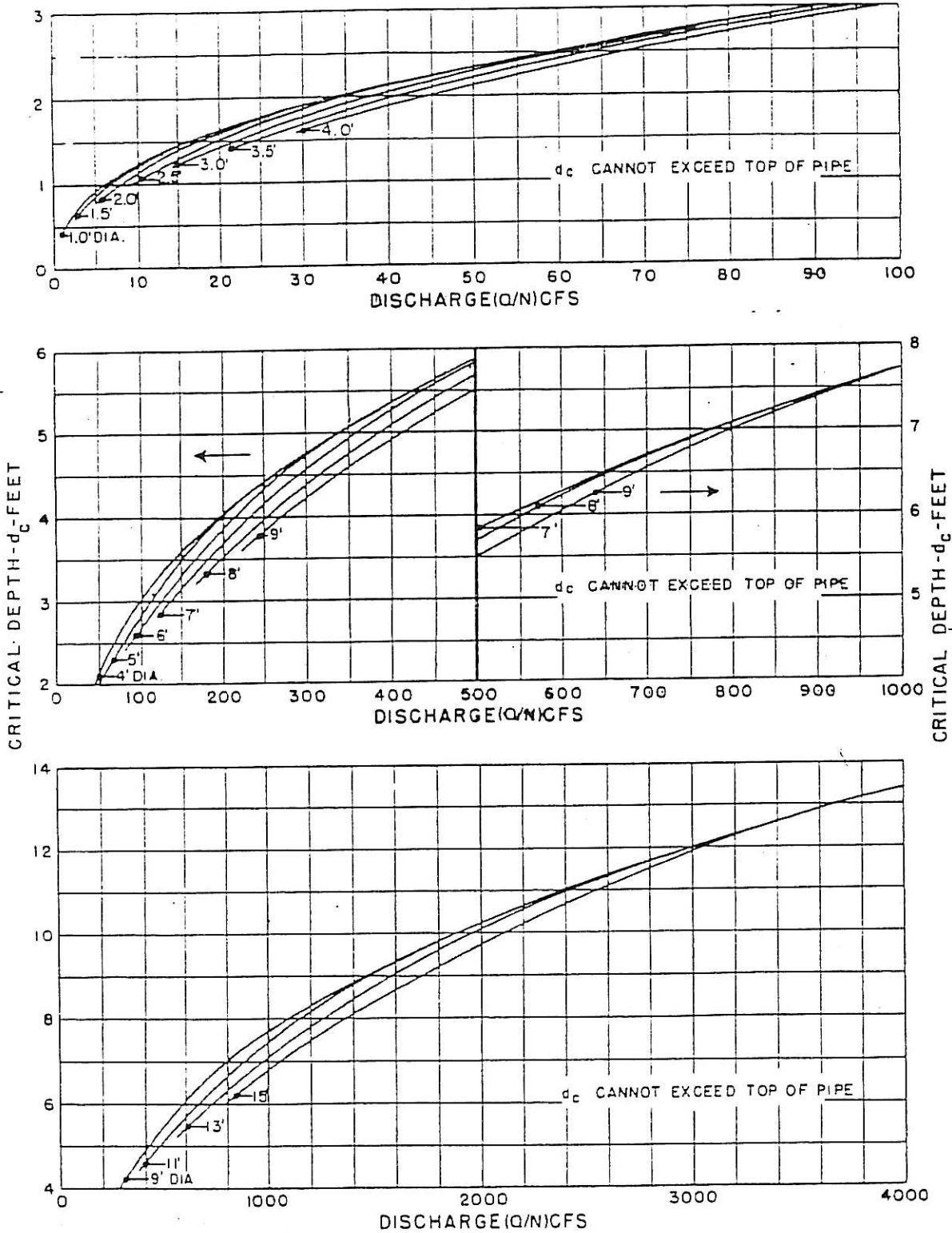

Exhibit 900-14
Critical Depth Circular Pipe
 Source: Arkansas Highway and Transportation Department Drainage Manual

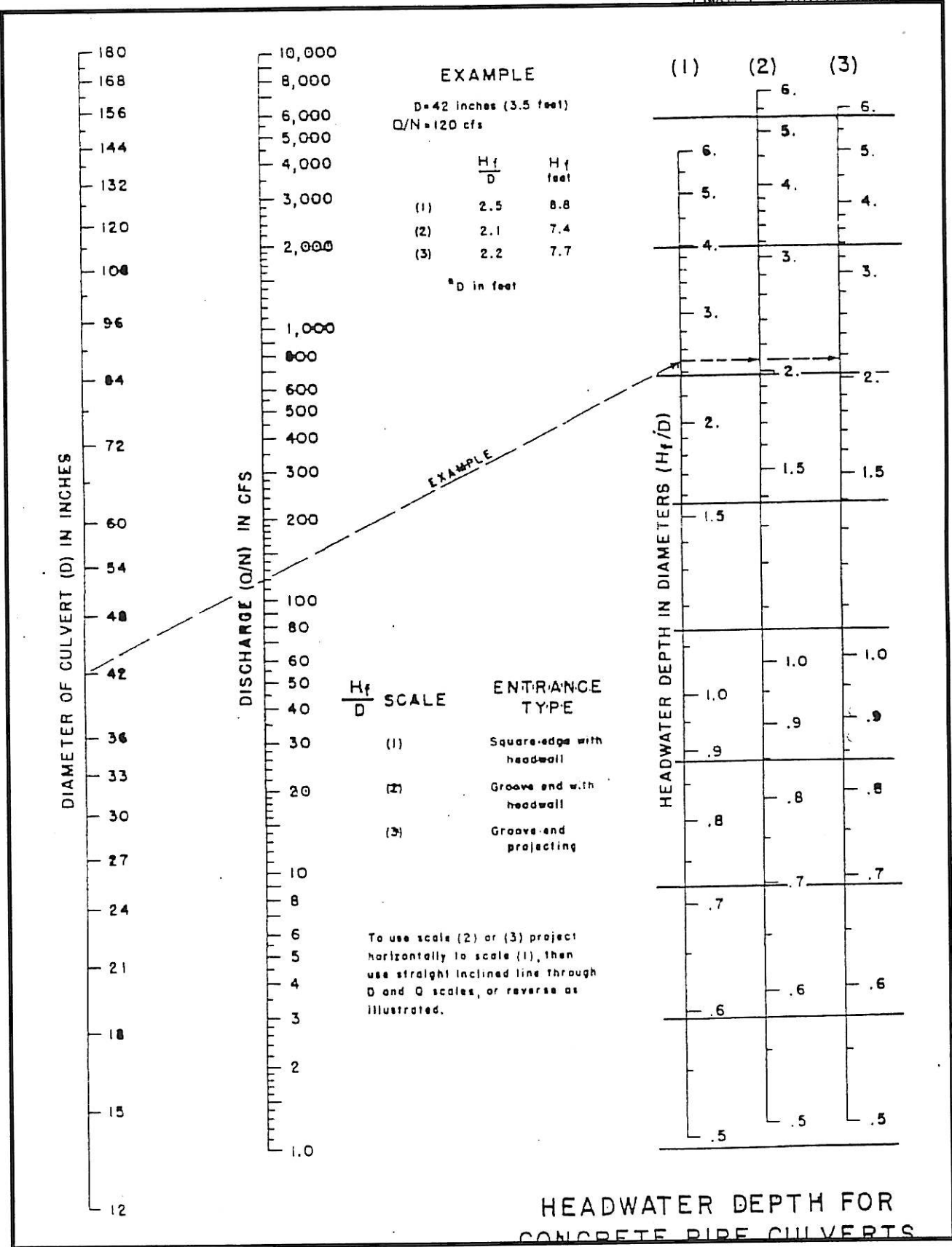

Exhibit 900-15
Headwater Depth for Concrete Pipe Culverts with Inlet Control
 Source: Arkansas Highway and Transportation Department Drainage Manual

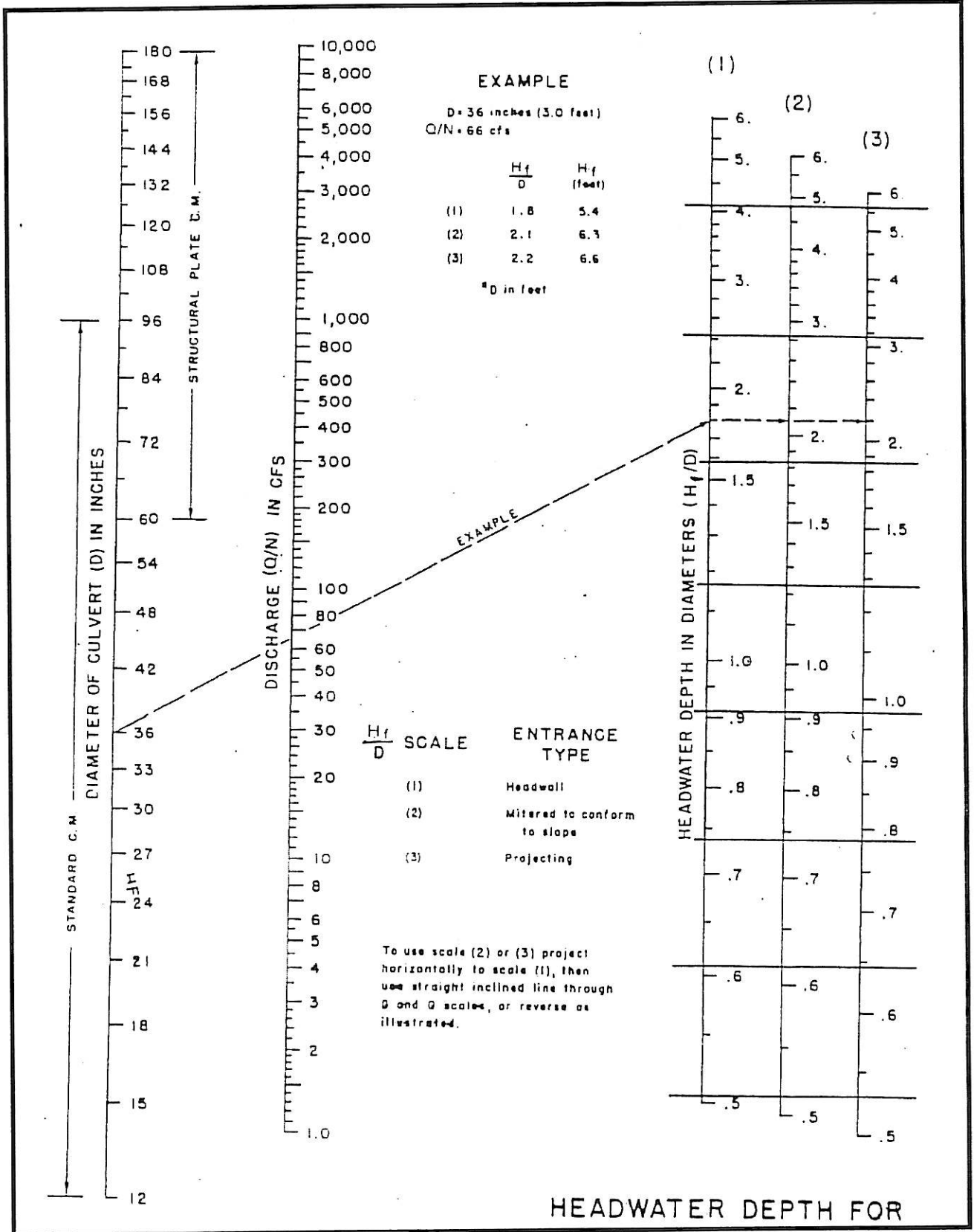

Exhibit 900-16

Headwater Depth for C.M. Pipe Culverts with Inlet Control

Source: Arkansas Highway and Transportation Department Drainage Manual

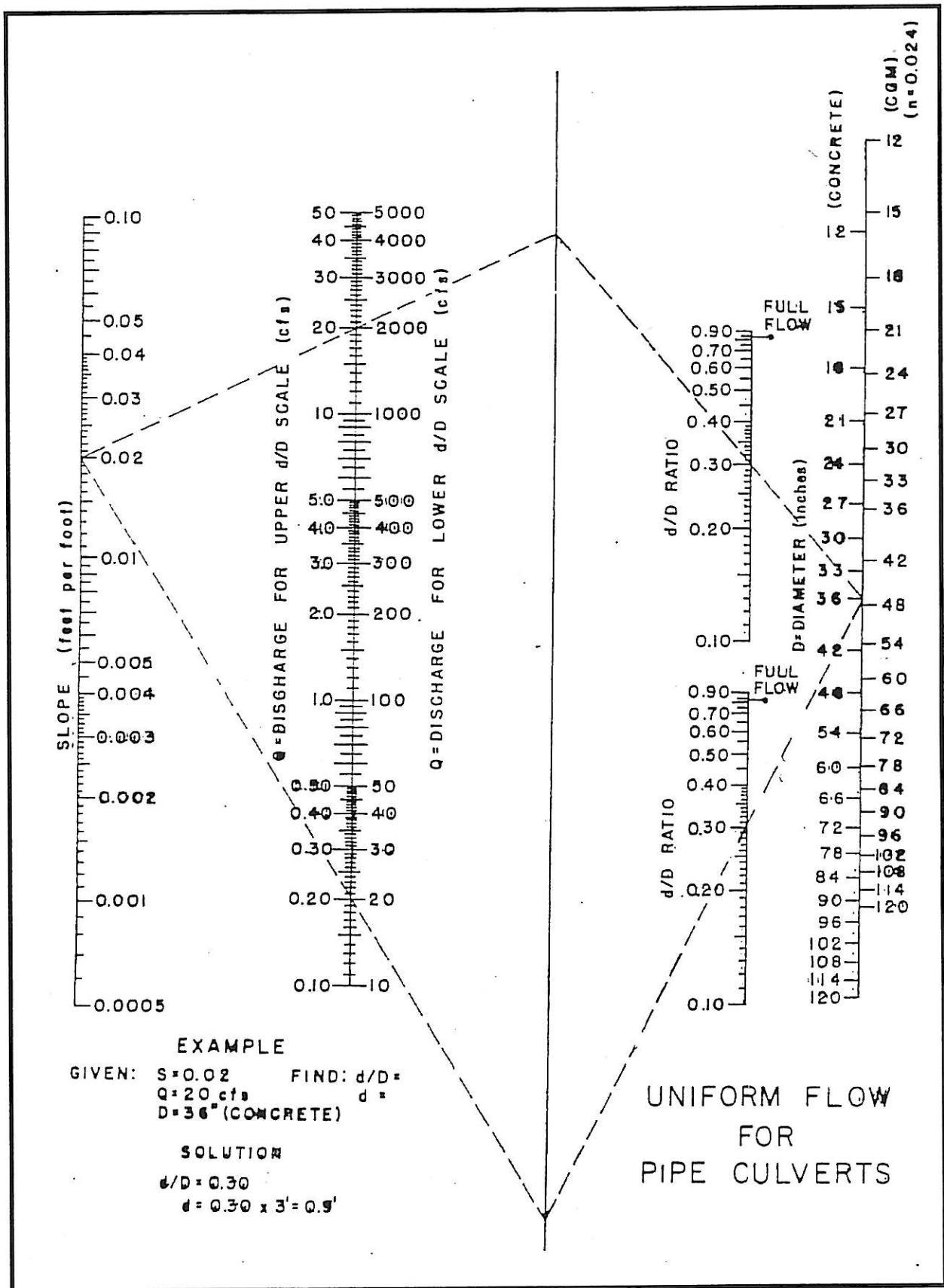

Exhibit 900-17

Uniform Flow for Pipe Culverts

Source: Arkansas Highway and Transportation Department Drainage Manual

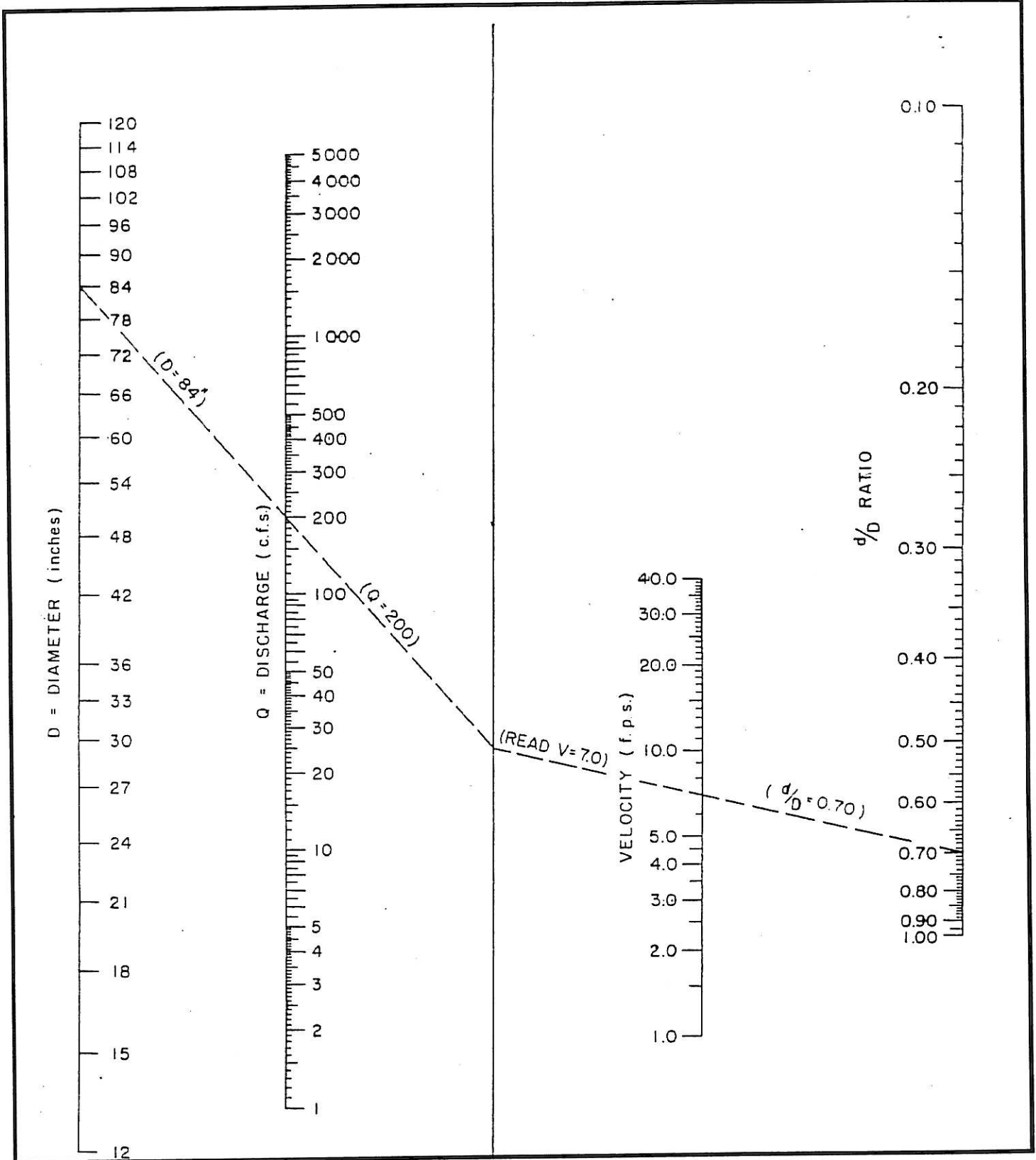

Exhibit 900-18
Velocity in Pipe Conduits

Source: Arkansas Highway and Transportation Department Drainage Manual

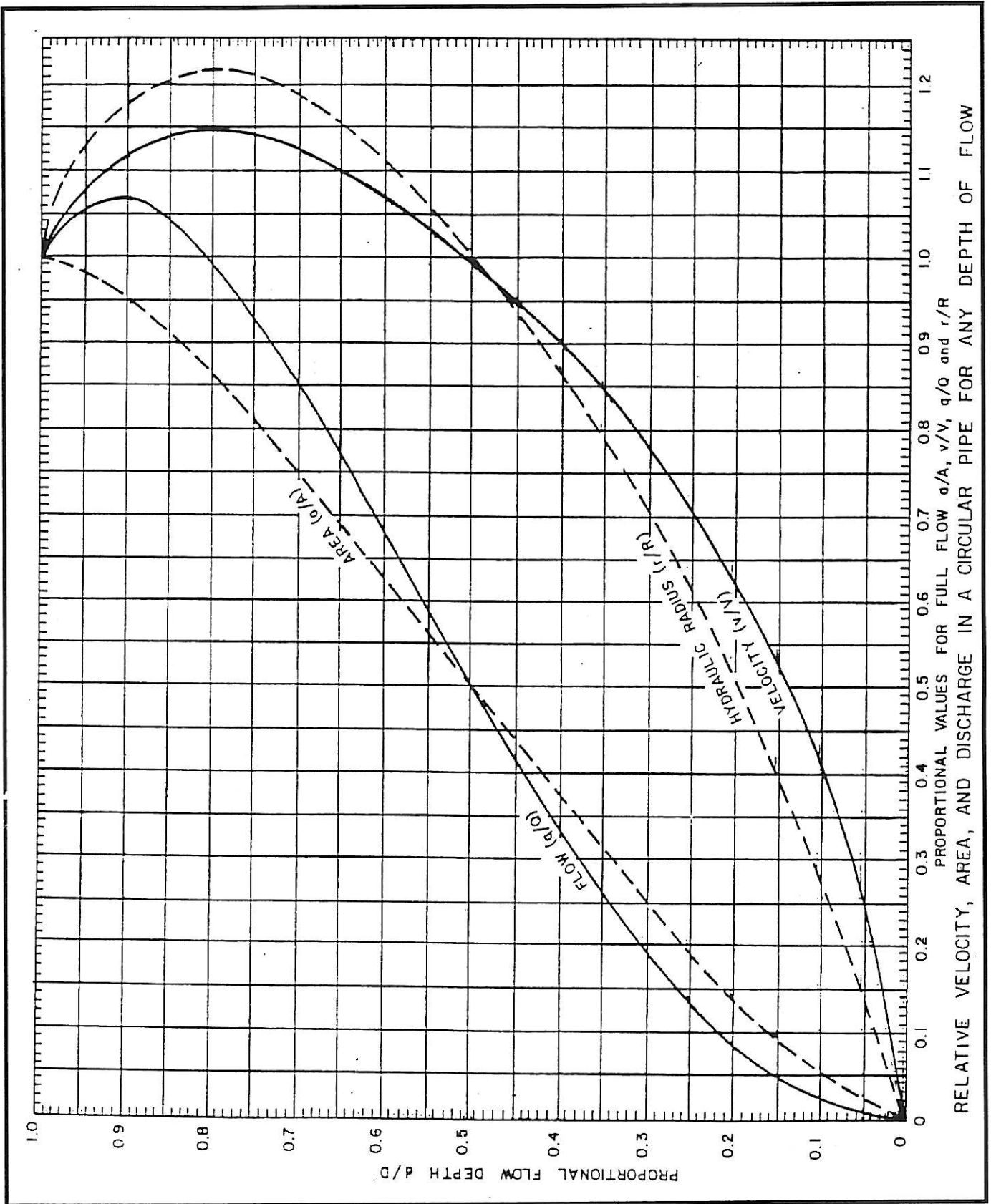

Exhibit 900-19
Relative Velocity, Area and Discharge in a Circular Pipe for any Depth of Flow
 Source: Arkansas Highway and Transportation Department Drainage Manual

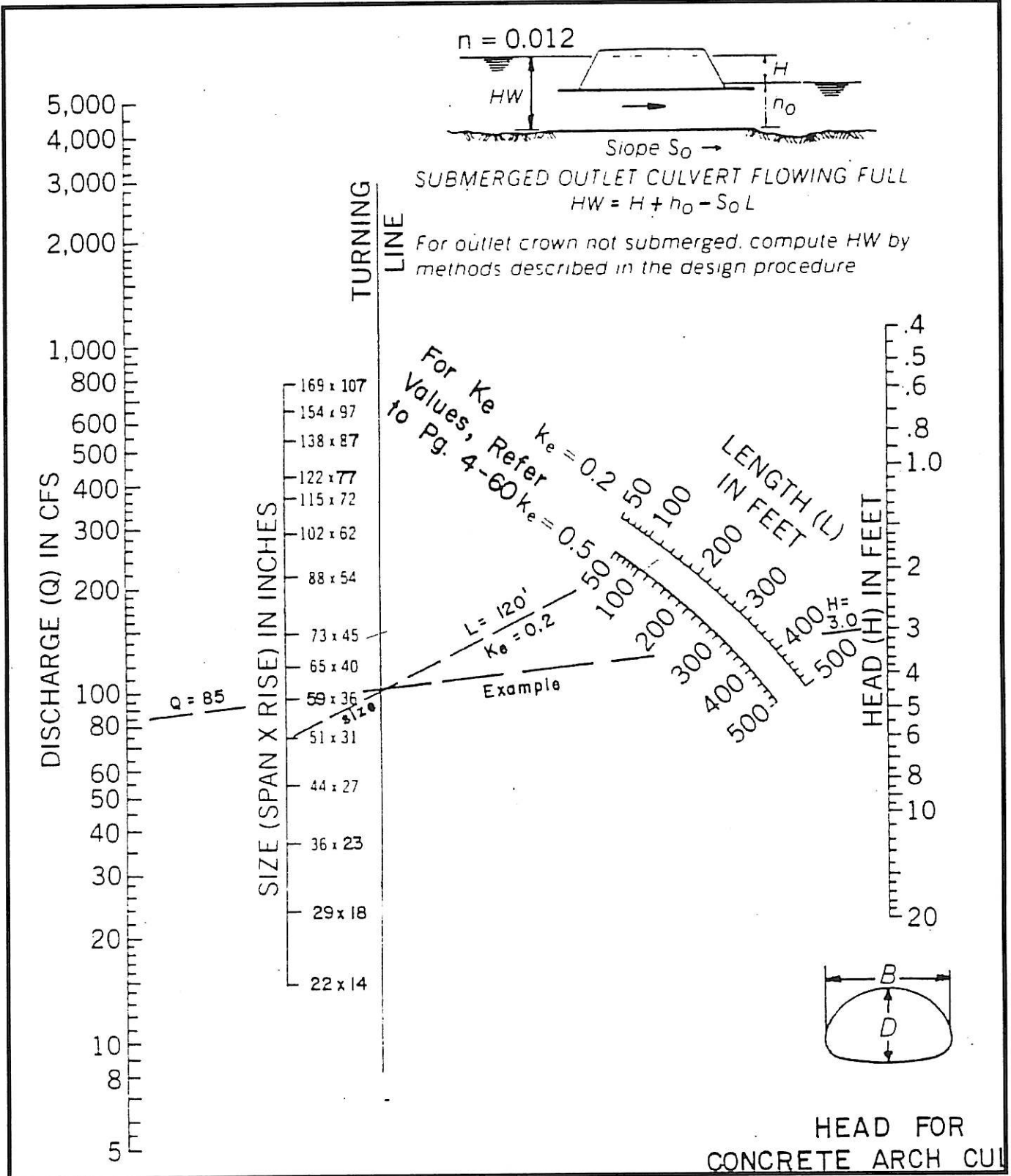

Exhibit 900-19.1
Head for Concrete Arch Culvert Flowing Full ($n=0.012$)
 Source: Arkansas Highway and Transportation Department Drainage Manual

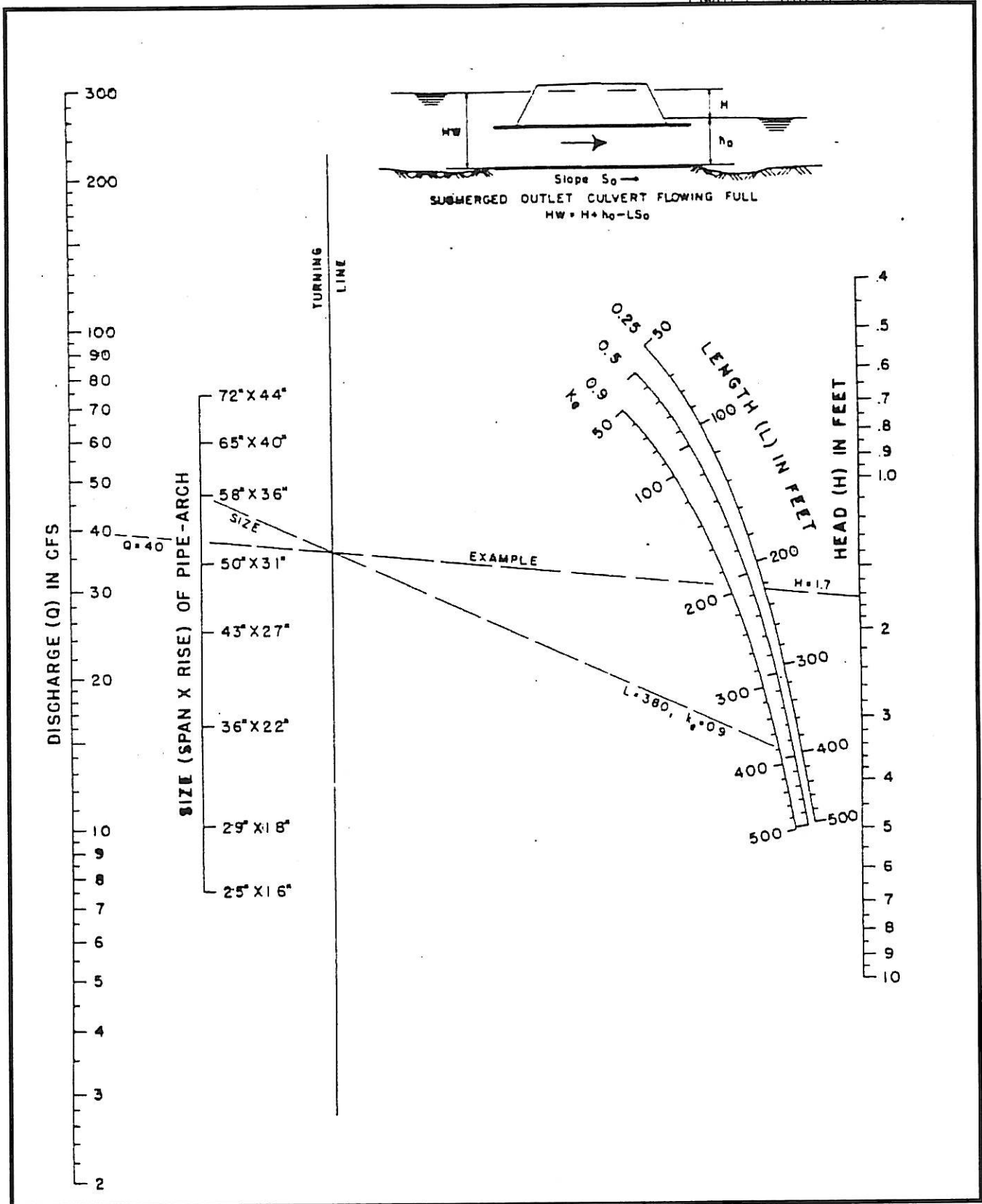

Exhibit 900-20
Head for Standard C.M. Pipe-Arch Culverts Flowing Full ($n = 0.024$)
 Source: Arkansas Highway and Transportation Department Drainage Manual

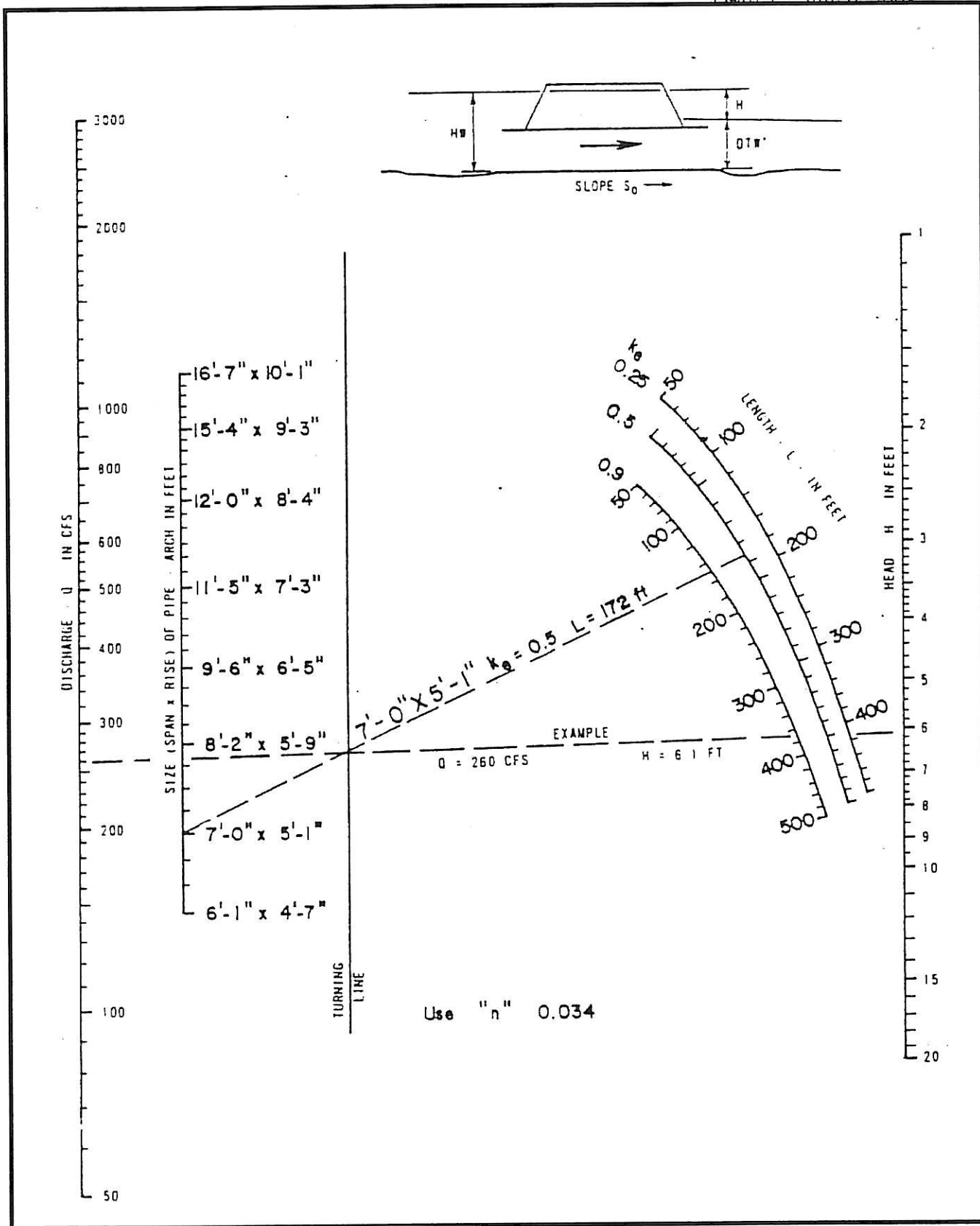

Exhibit 900-20.1
 Head for Structural Plate C.M. P. Arch
 Source: Arkansas Highway and Transportation Department Drainage Manual

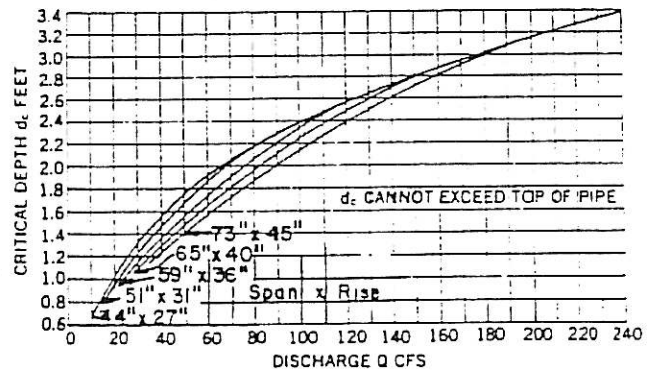
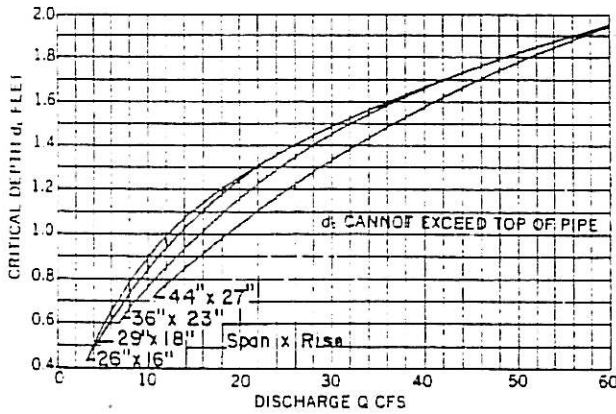
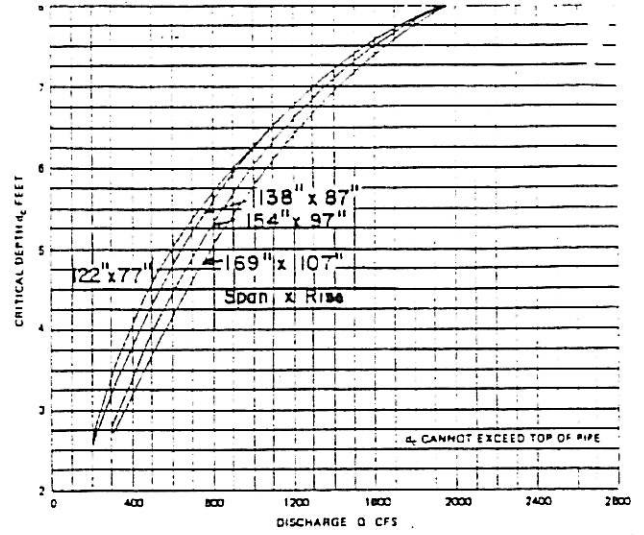
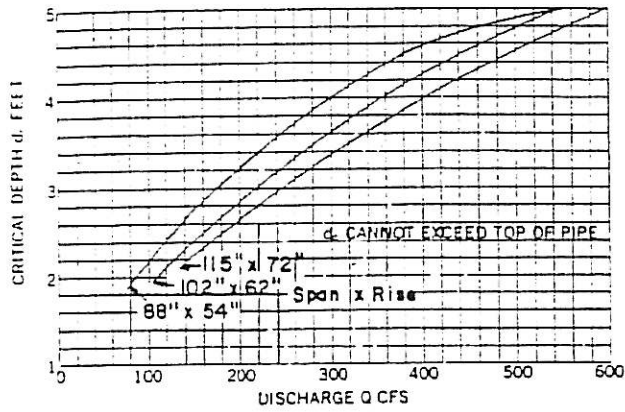

Exhibit 900-20.2
Critical Depth Concrete Arch Pipe
 Source: Arkansas Highway and Transportation Department Drainage Manual

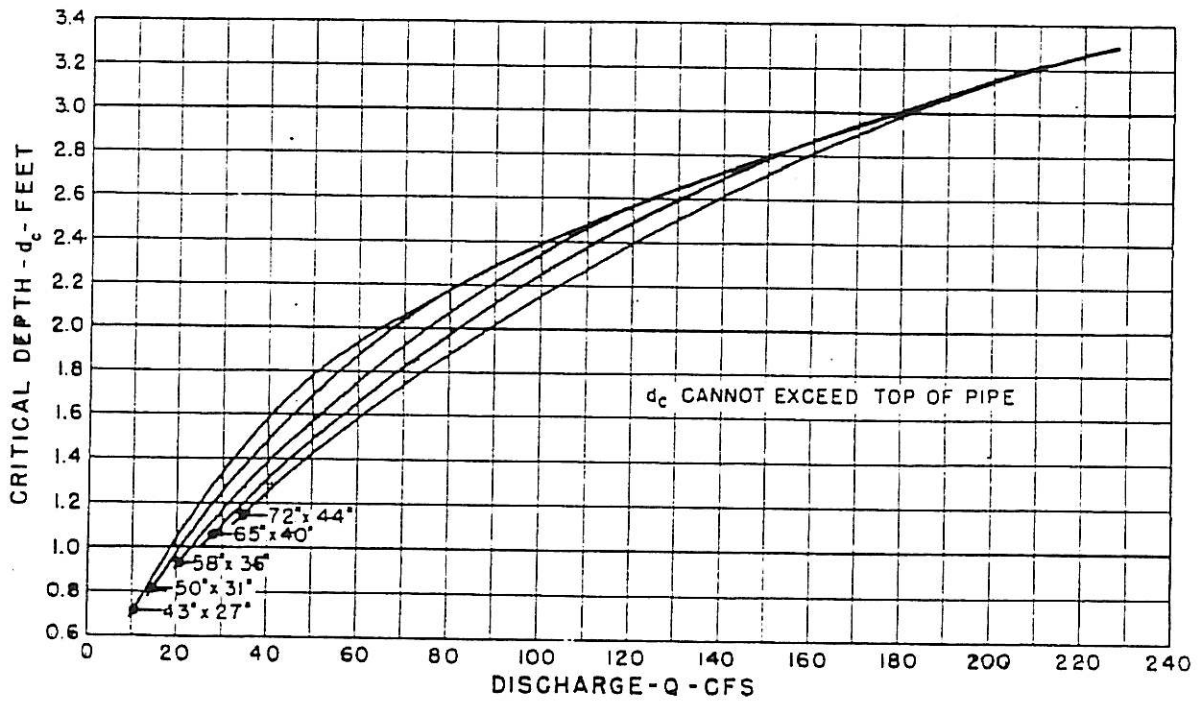
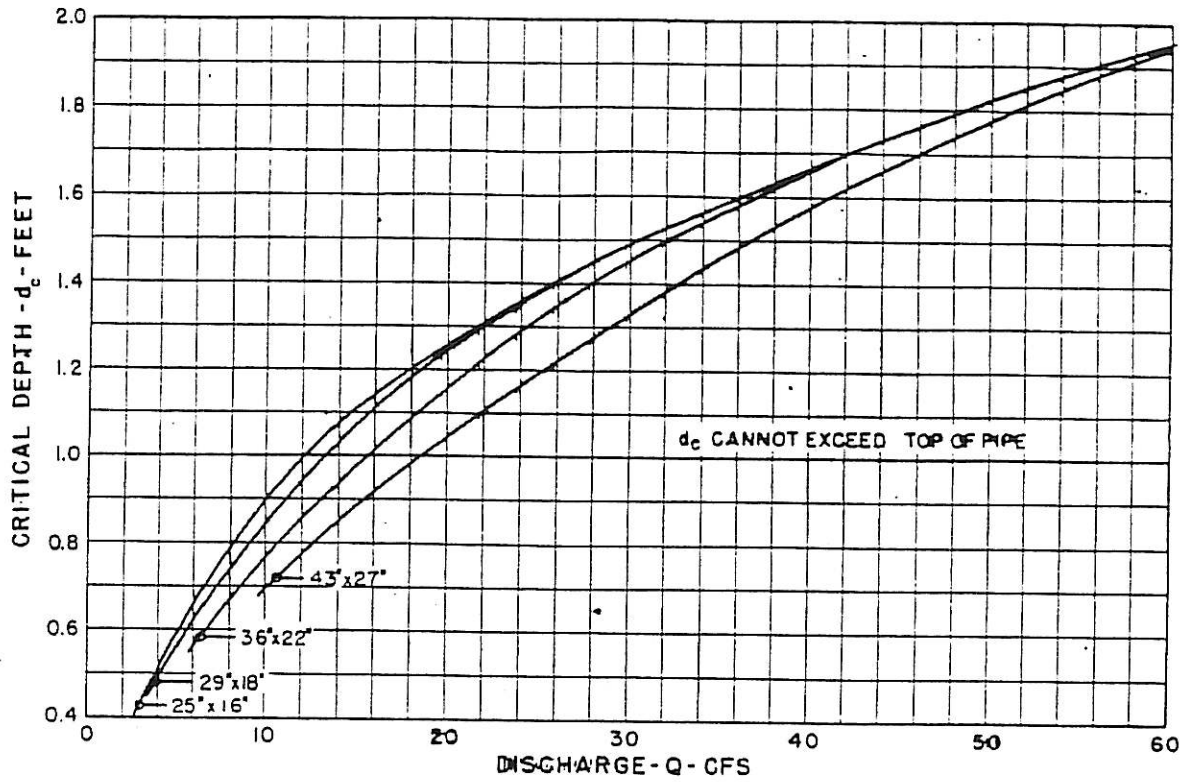

Exhibit 900-21
Critical Depth Standard C.M. Pipe-Arch
Source: Arkansas Highway and Transportation Department Drainage Manual

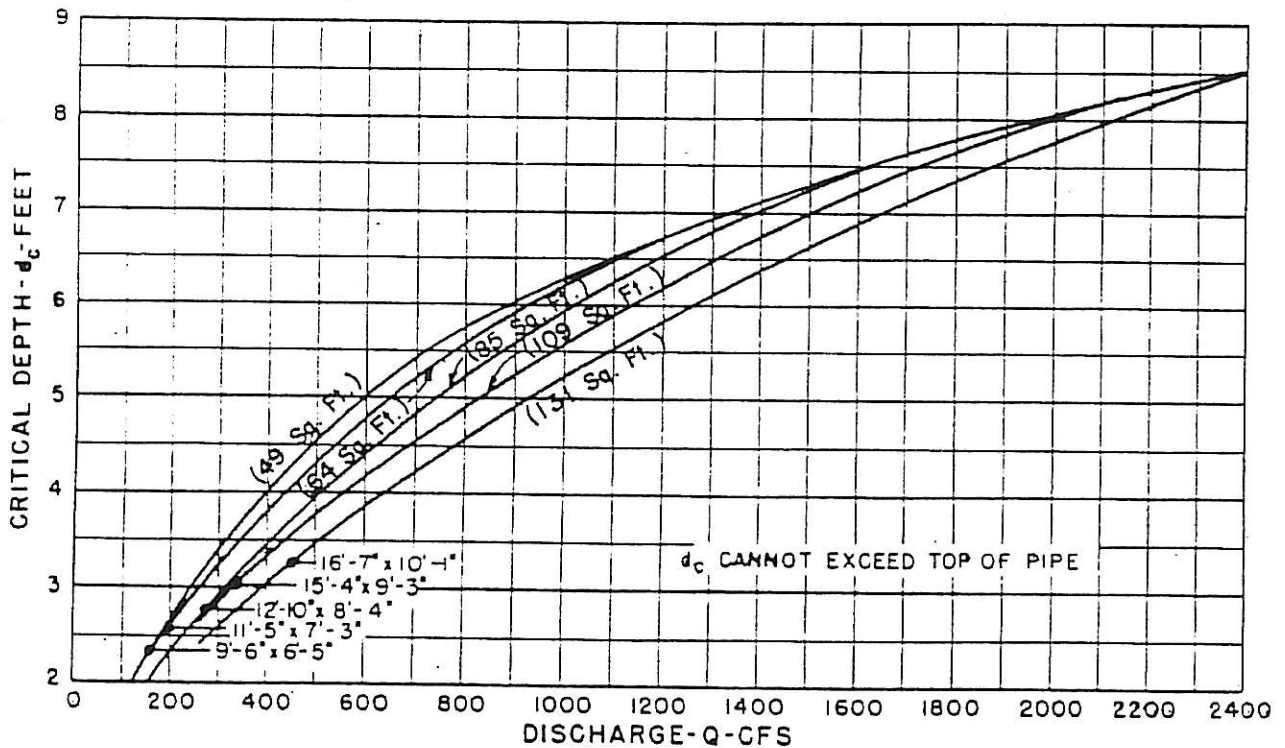
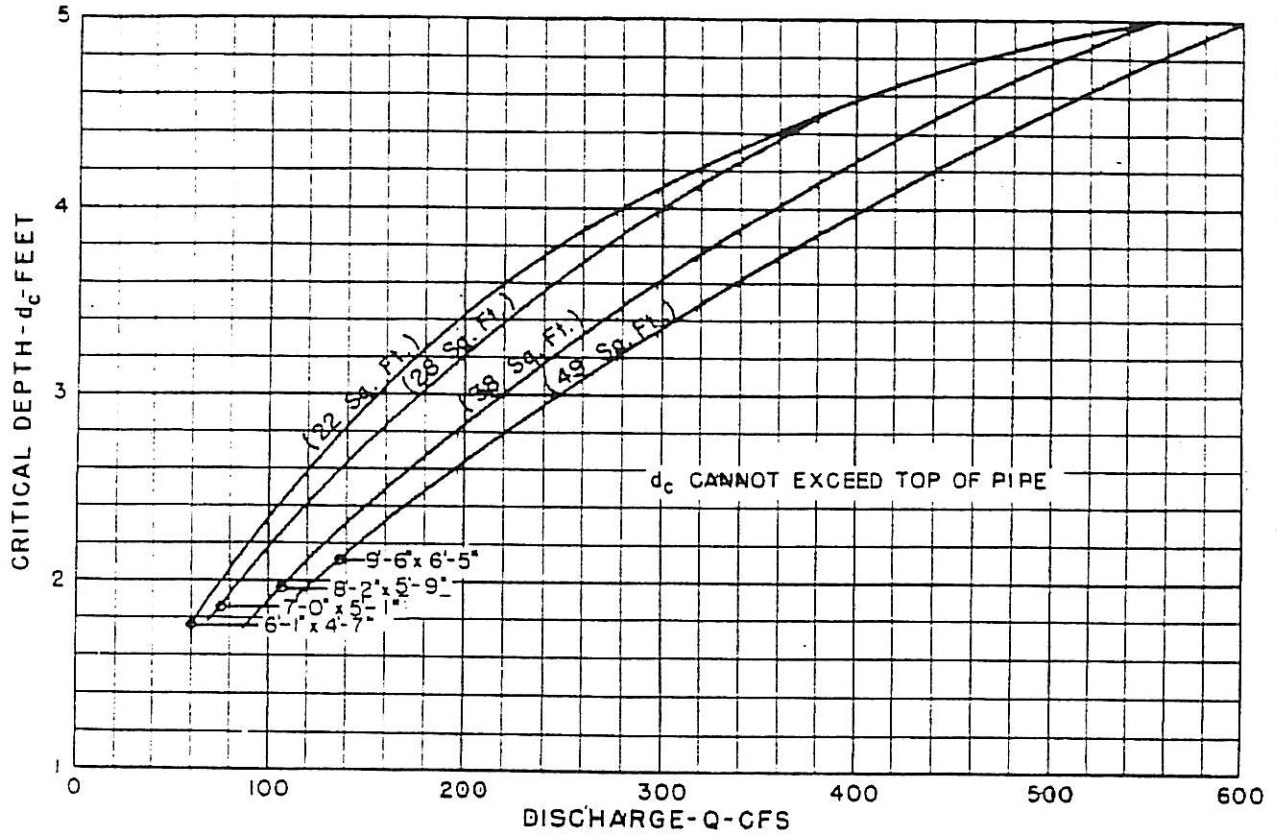

Exhibit 900-22

Critical Depth Structural Plate C.M. Pipe-Arch

Source: Arkansas Highway and Transportation Department Drainage Manual

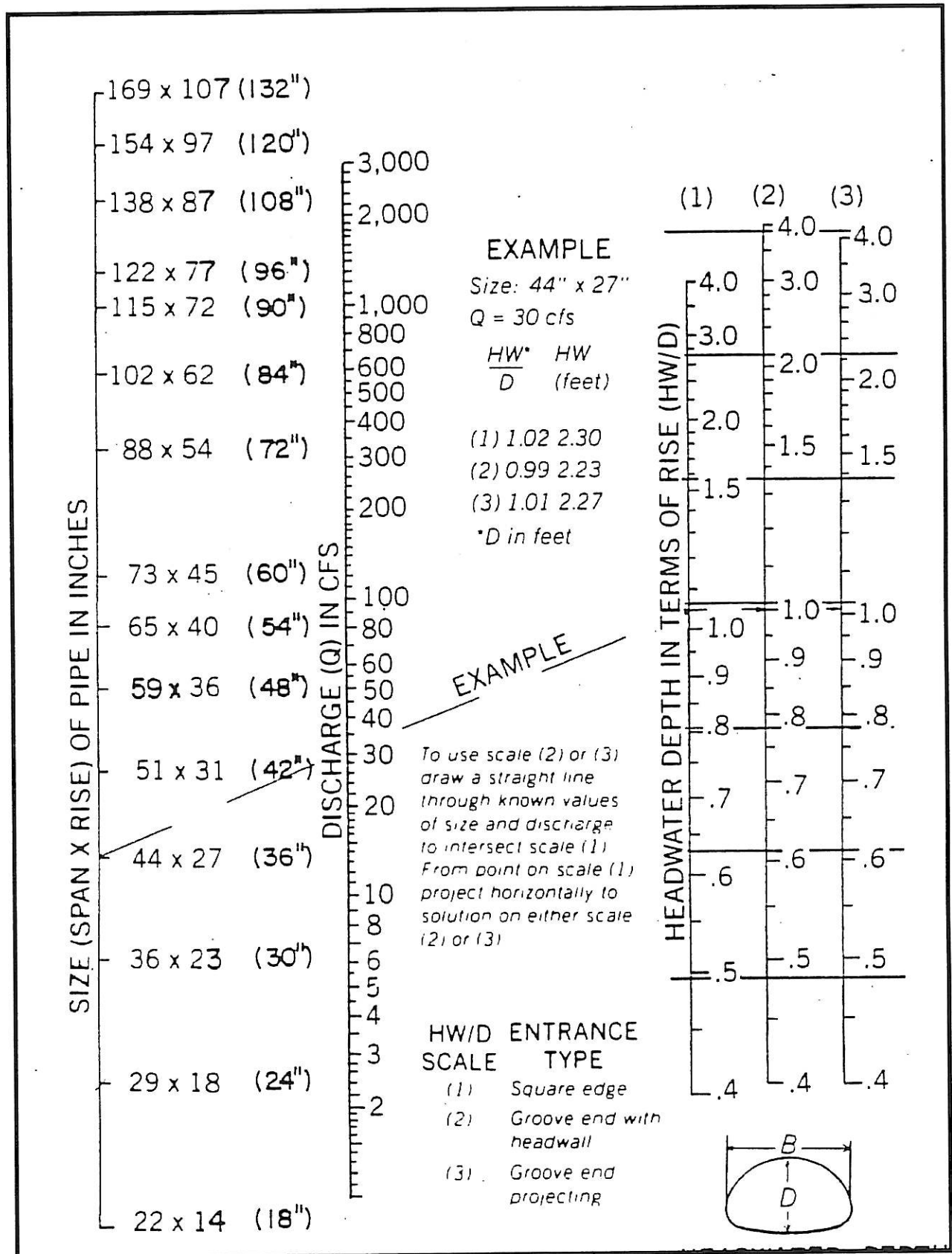

Exhibit 900-22.1

Headwater Depth for Concrete Arch Culverts with Inlet Control

Source: Arkansas Highway and Transportation Department Drainage Manual

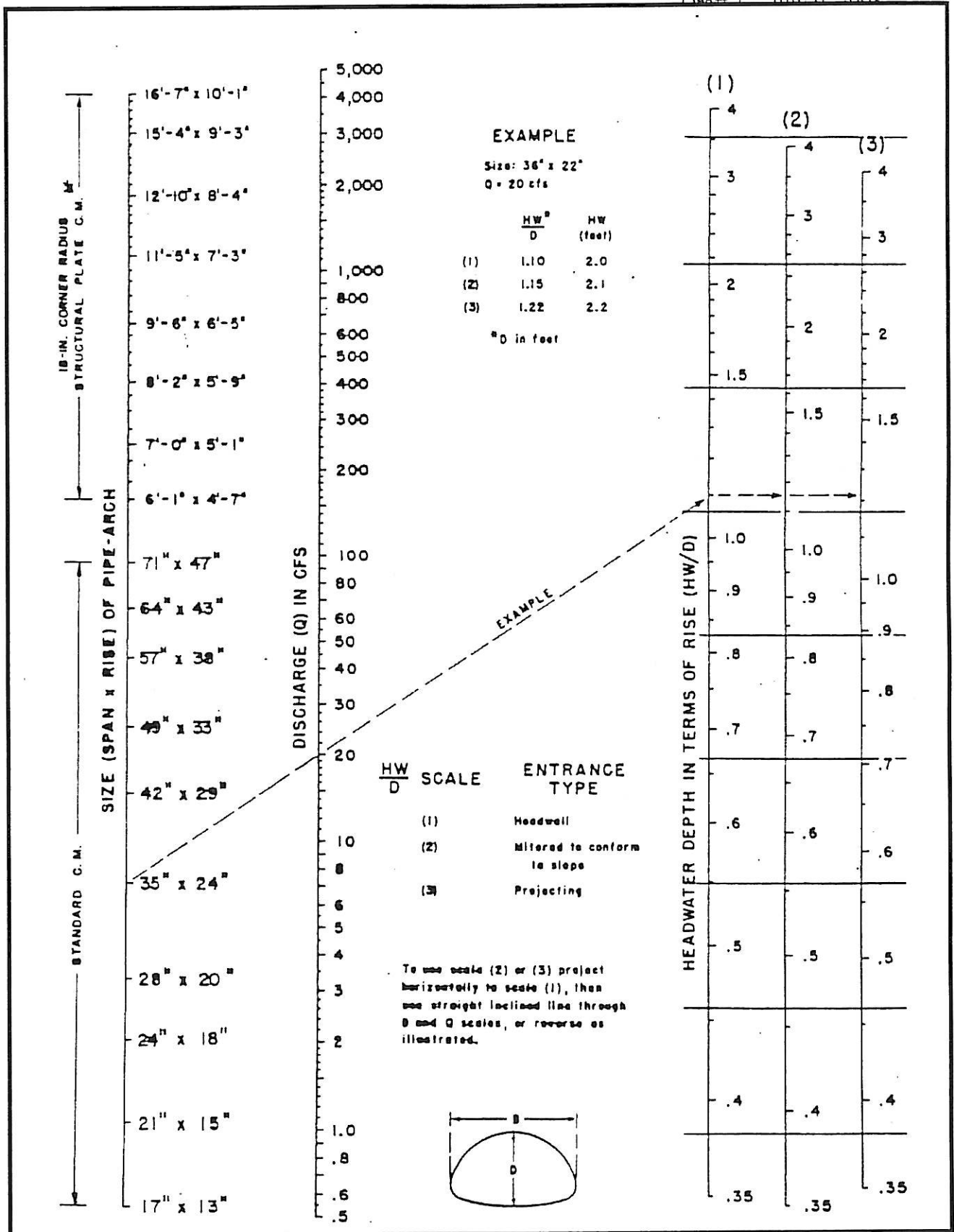

Exhibit 900-23

Headwater Depth for C.M. Pipe-Arch Culverts with Inlet Control

Source: Arkansas Highway and Transportation Department Drainage Manual

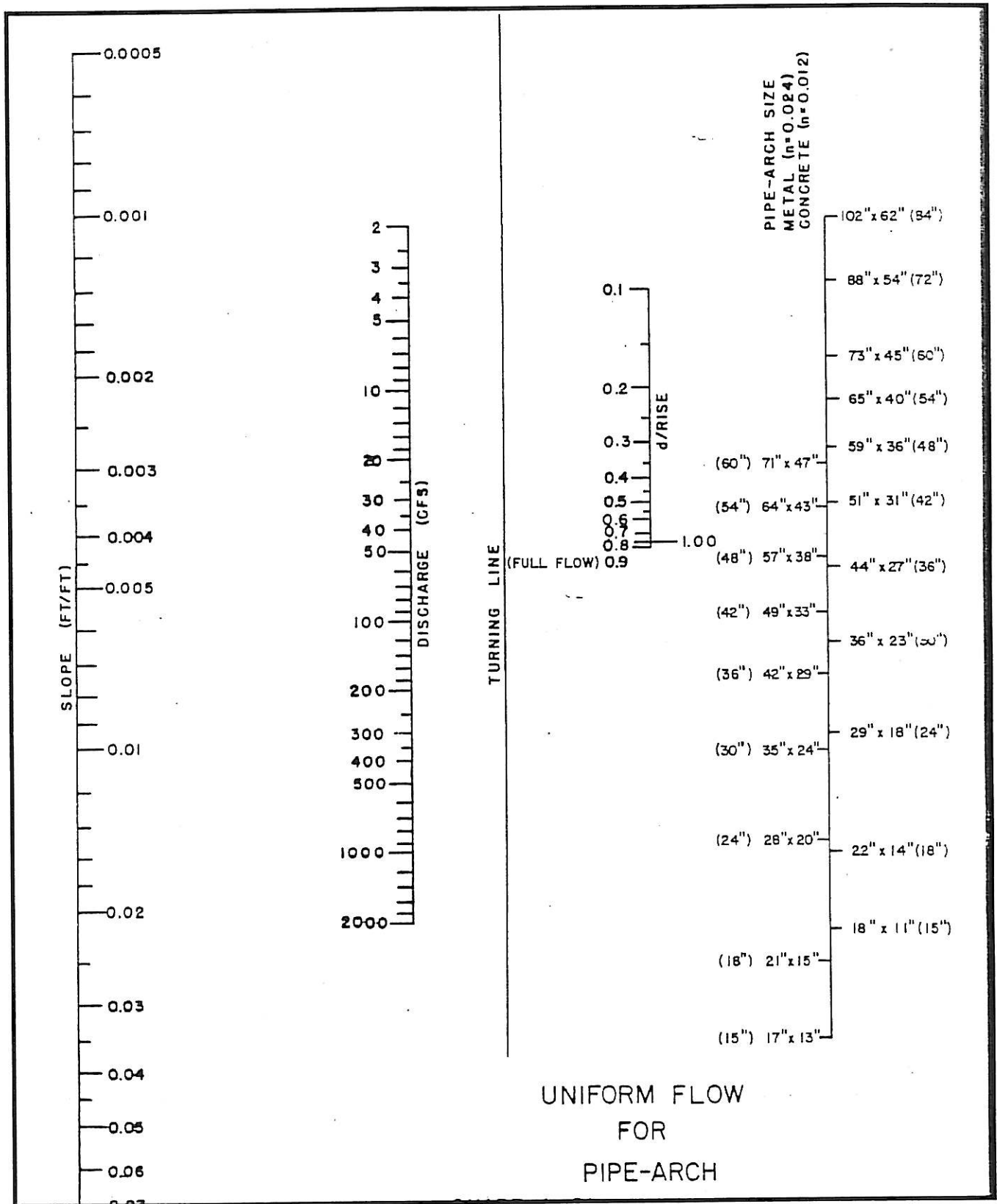

Exhibit 900-24
Uniform Flow for Pipe-Arch
 Source: Arkansas Highway and Transportation Department Drainage Manual

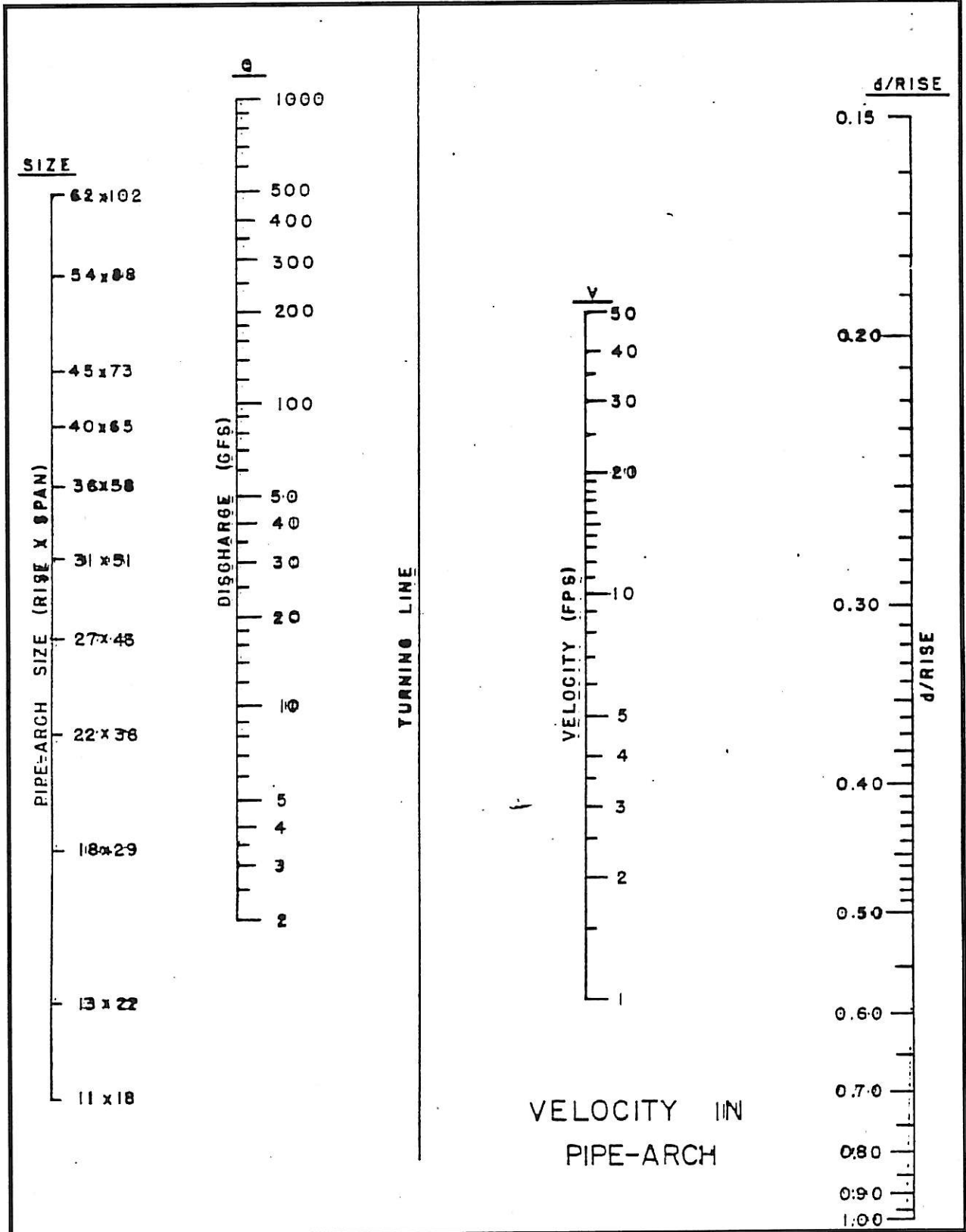

Exhibit 900-25

Velocity in Pipe-Arch

Source: Arkansas Highway and Transportation Department Drainage Manual

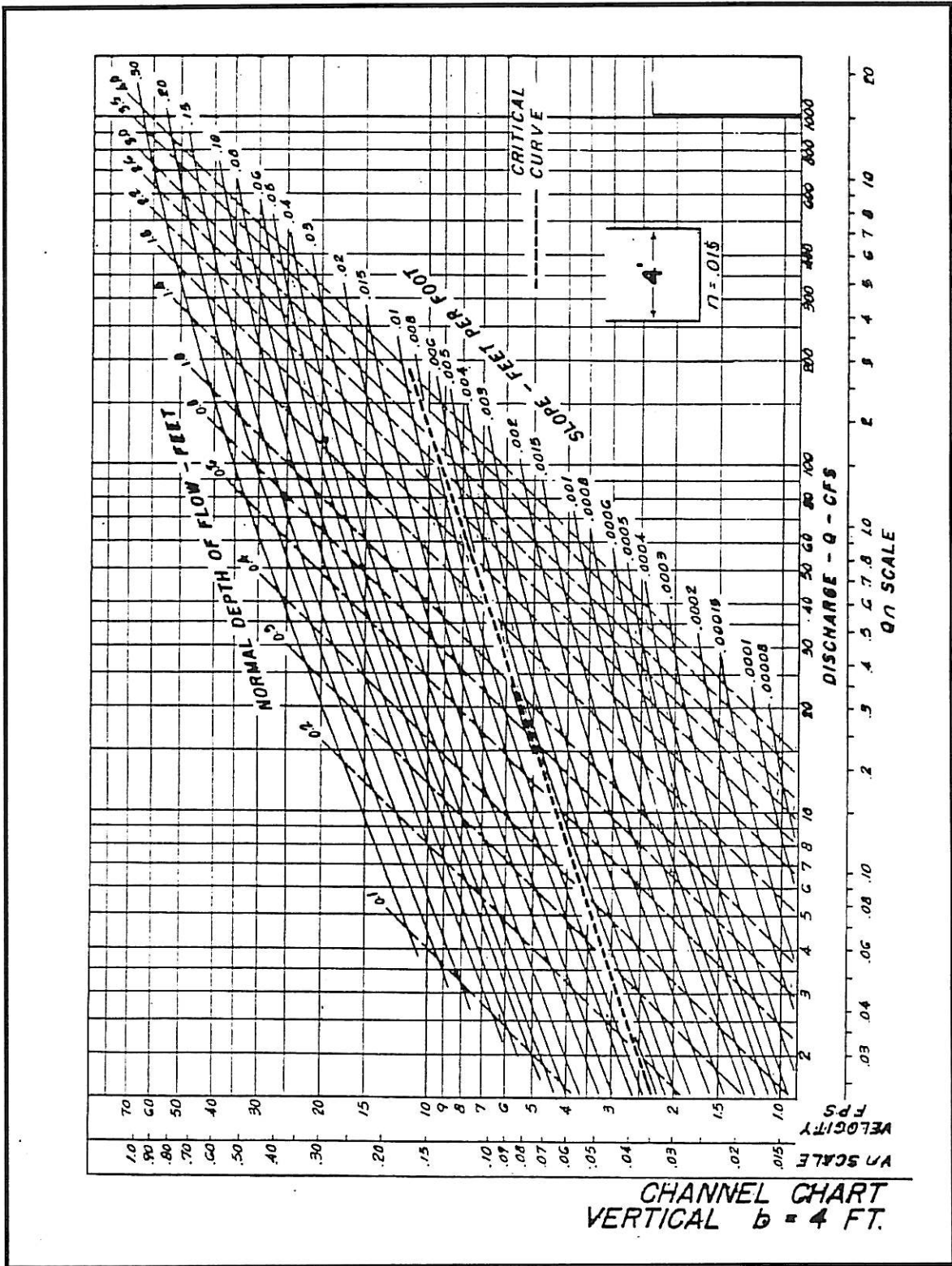

Exhibit 900-26

Source: Arkansas Highway and Transportation Department Drainage Manual

Table 900-10
Entrance Loss Coefficients

Source: Arkansas Highway and Transportation Department Drainage Manual

ENTRANCE LOSS COEFFICIENTS	
Outlet Control, Full or Partly Full	
Entrance head loss $H_e = K_e \frac{v^2}{2g}$	
<u>Types of Structure and Design of Entrance</u>	<u>Coefficient K_e</u>
<u>PIPE, CONCRETE</u>	
Projecting from fill, socket end (groove-end)	0.2
Projecting from fill, square cut end	0.5
Headwall or headwall and wingwalls	
Socket end of pipe (groove-end)	0.2
Square-edge	0.5
Round (Radius = 1/12D)	0.2
Mitered to conform to fill slope	0.7
End-Section conforming to fill slope	0.5
Beveled edges, 33.7° to 45° bevels	0.2
Side or slope-tapered inlet	0.2
<u>PIPE, OR PIPE-ARCH, CORRUGATED METAL</u>	
Projecting from fill (no headwall)	0.9
Headwall or headwall and wingwalls square-edge	0.5
Mitered to conform to fill slope, pave or unpaved slope	0.7
End-Section conforming to fill slope	0.5
Reveled edges, 33.7° or 45° bevels	0.2
Side or slope-tapered inlet	0.2
<u>BOX, REINFORCED CONCRETE</u>	
Headwall parallel embankment (no wingwalls)	
Square-edged on 3 edges	0.5
Rounded on 3 edges to radius of 1/12 barrel dimension, or beveled edges on 3 sides	0.2
Wingwalls at 30° to 75° to barrel	
Square-edges at crown	0.4
Crown edge rounded to radius of 1/12 barrel dimension, or beveled top edge	0.2
Wingwall at 10° to 25° to barrel	
Square-edged at crown	0.5
Wingwalls parallel (extension of sides)	
Square-edged at crown	0.7
Side or slope-tapered inlet	0.2

Values of $1.486 \times R^{2/3} \times A$

Diameter, Inches	Area in Sq. Ft.	Hydraulic Radius	R ^{2/3}	AR ^{2/3}	n								
					n ^{1/10}	n ^{1/11}	n ^{1/12}	n ^{1/13}	n ^{1/14}	n ^{1/15}	n ^{1/16}	n ^{1/17}	
6	.196	.125	.250	.049	7.281	6.619	6.068	5.601	3.467	3.034	2.913	2.427	2.275
8	.349	.167	.303	.106	15.75	14.32	13.13	12.12	7.501	6.563	6.301	5.25	4.92
10	.545	.208	.351	.191	28.38	25.80	23.65	21.83	13.52	11.83	11.35	9.46	8.81
12	.785	.250	.397	.312	46.36	42.15	38.64	35.66	22.08	19.32	18.55	15.45	14.49
15	1.227	.3125	.461	.566	84.11	76.46	70.09	64.70	40.05	35.04	33.64	28.04	26.28
18	1.767	.375	.520	.919	136.6	124.2	113.8	105.1	65.03	56.90	54.63	45.53	42.69
21	2.405	.437	.576	1.385	205.8	187.1	171.5	158.3	98.01	85.75	82.32	68.60	64.31
24	3.142	.50	.630	1.979	294.1	267.4	245.1	226.2	140.0	122.5	117.6	98.03	91.91
27	3.976	.5625	.681	2.708	402.4	365.8	335.3	309.6	191.6	167.7	161.0	134.1	125.7
30	4.909	.625	.731	3.588	533.2	484.7	444.3	410.1	253.9	222.2	213.3	177.7	166.6
36	7.069	.75	.825	5.832	866.6	787.9	722.2	666.6	412.7	361.1	346.7	288.9	270.8
42	9.621	.875	.915	8.803	1308	1189	1090	1006	622.9	545.0	523.3	436.0	408.8
48	12.566	1.00	1.00	12.566	1867	1698	1556	1436	889.2	778.0	746.9	622.3	583.4
54	15.904	1.125	1.082	17.208	2557	2325	2131	1967	1218	1065	1023	852.3	799.1
60	19.635	1.25	1.16	22.777	3385	3077	2821	2604	1612	1410	1354	1128	1058
66	23.758	1.375	1.236	29.365	4364	3967	3636	3357	2078	1818	1745	1455	1364
72	28.274	1.50	1.310	37.039	5504	5004	4587	4234	2621	2293	2202	1835	1720
78	33.183	1.625	1.382	45.859	6815	6195	5679	5242	3245	2839	2726	2272	2130
84	38.485	1.75	1.452	55.880	8304	7549	6920	6388	3954	3460	3322	2768	2595
90	44.179	1.875	1.521	67.196	9985	9078	8321	7681	4755	4161	3994	3328	3120
96	50.266	2.00	1.587	79.772	11854	10776	9878	9119	5615	4939	4742	3951	3704
102	56.745	2.125	1.653	93.799	13939	12671	11615	10722	6637	5808	5575	4646	4356
108	63.617	2.25	1.717	109.230	16232	14756	13526	12486	7729	6763	6493	5411	5073
114	70.882	2.375	1.780	126.170	18749	17044	15624	14422	8928	7812	7500	6250	5859
120	78.54	2.5	1.842	144.671	21498	19544	17915	16537	10237	8957	8599	7166	6718

MANNING'S FORMULA: $Q = \frac{1.486}{n} AR^{2/3} S^{1/2}$

Table 900-11

Table for Solving Manning's Formula for Conduits Flowing Full

Source: Arkansas Highway and Transportation Department Drainage Manual

Round Pipe		Pipe-Arch (½ in Corrugation)		Structural Plate Pipe-Arch		
Diameter (Inches)	Area Square Feet	Size		Feet	Inches	Area Square Feet
		Size	Area			
12	.785	17 x 13	1.1	18-inch Corner Radius R _c		
15	1.227	21 x 15	1.6	6-1 x 4-7		22
18	1.767	24 x 18	2.2	6-4 x 4-9		24
21	2.405	28 x 20	2.9	6-9 x 4-11		26
24	3.142	35 x 24	4.5	7-0 x 5-1		28
30	4.909	42 x 29	6.5	7-3 x 5-3		31
36	7.069	49 x 33	8.9	7-8 x 5-5		33
42	9.621	57 x 38	11.6	7-11 x 5-7		35
48	12.566	64 x 43	14.7	8-2 x 5-9		38
54	15.904	71 x 47	18.1	8-7 x 5-11		40
60	19.635	77 x 52	21.9	8-10 x 6-1		43
66	23.758	83 x 57	26.0	9-4 x 6-3		46
72	28.27			9-6 x 6-5		49
78	33.18			9-9 x 6-7		52
84	38.49			10-3 x 6-9		55
90	44.18			10-8 x 6-11		58
96	50.27	Pipe-Arch (1 in Corrugation)		10-11 x 7-1		61
108	63.62			11-5 x 7-3		64
114	70.88			11-7 x 7-5		67
120	78.54			11-10 x 7-7		71
126	86.59			12-4 x 7-9		74
132	95.03	60 x 46	15.6	12-6 x 7-11		78
138	103.87	66 x 51	19.3	12-8 x 8-1		81
144	113.10	73 x 55	23.2	12-10 x 8-4		85
150	122.7	81 x 59	27.4	13-5 x 8-5		89
156	132.7	87 x 63	32.1	13-11 x 8-7		93
162	143.1	95 x 67	37.0	14-1 x 8-9		97
168	153.9	103 x 71	42.4	14-3 x 8-11		101
174	165.1	112 x 75	48.0	14-10 x 9-1		105
180	176.7	117 x 79	54.2	15-4 x 9-3		109
186	188.7	128 x 83	60.5	15-6 x 9-5		113
192	201.1	137 x 87	67.4	15-8 x 9-7		118
198	213.8	142 x 91	74.5	15-10 x 9-10		122
204	227.0			16-5 x 9-11		125
210	240.5			16-7 x 10-1		131
216	254.5			31 inch Corner Radius R _c		
222	268.8	Structural Plate Arch		13-3 x 9-4		97
228	283.5			13-6 x 9-6		102
234	298.6			14-0 x 9-8		105
240	314.2			14-2 x 9-10		109
246	330.1			14-5 x 10-0		114
252	346.4	6.0 x 3-2	15	14-11 x 10-2		118
258	363.1	7.0 x 3-8	20	15-4 x 10-4		123
264	380.1	8.0 x 4-2	26	15-7 x 10-6		127
270	397.6	9.0 x 4-8½	33	15-10 x 10-8		132
276	415.5	10.0 x 5-3	41	16-3 x 10-10		137
282	433.7	11.0 x 5-9	50	16-6 x 11-0		142
288	452.4	12.0 x 6-3	59	17-0 x 11-2		146
294	471.4	13.0 x 6-9	70	17-2 x 11-4		151
300	490.9	14.0 x 7-3	80	17-5 x 11-6		157
		15.0 x 7-9	92	17-11 x 11-8		161
		16.0 x 8-3	105	18-1 x 11-10		167
		17.0 x 8-10	119	18-7 x 12-0		172
		18.0 x 8-11	126	18-0 x 12-2		177
		19.0 x 9-5½	140	19-3 x 12-4		182
		20.0 x 10-0	157	19-6 x 12-6		188
		21.0 x 10-6	172	19-8 x 12-8		194
		22.0 x 11-0	190	19-11 x 12-10		200
		23.0 x 11-6	172	20-5 x 13-0		205
		24.0 x 12-0	226	20-7 x 13-2		211
		25.0 x 12-6	247			

Table 900-12
Waterway Areas for Standard Sizes of Corrugated Steel Conduits
Source: Arkansas Highway and Transportation Department Drainage Manual

Hydraulic Properties of Circular Conduits Flowing Partly Full

d = Depth of flow
 d_c = Critical depth
 d_m = Mean depth

D = Diameter of pipe
 A = Area of flow
 R = Hydraulic radius
 T = Top width of flow

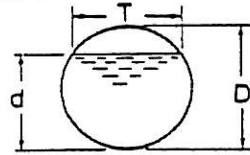

$\frac{d}{D}$ or $\frac{d_c}{D}$	$\frac{A}{D^2}$	$\frac{R}{D}$	$\frac{T}{D}$	$\frac{d_m}{D}$
1.00	0.7854	0.2500	—	—
0.95	0.7707	0.2865	0.4359	1.7681
0.90	0.7445	0.2980	0.6000	1.2408
0.85	0.7115	0.3033	0.7142	0.9962
0.80	0.6736	0.3042	0.8000	0.8420
0.75	0.6319	0.3017	0.8660	0.7297
0.70	0.5872	0.2962	0.9165	0.6407
0.65	0.5404	0.2882	0.9539	0.5665
0.60	0.4920	0.2776	0.9798	0.5021
0.55	0.4426	0.2649	0.9950	0.4448
0.50	0.3927	0.2500	1.0000	0.3927
0.45	0.3428	0.2331	0.9950	0.3445
0.40	0.2934	0.2142	0.9798	0.2994
0.35	0.2450	0.1935	0.9539	0.2568
0.30	0.1982	0.1709	0.9165	0.2163
0.25	0.1535	0.1466	0.8660	0.1773
0.20	0.1118	0.1206	0.8000	0.1397
0.15	0.0739	0.0929	0.7142	0.1035

Hydraulic Properties of Pipe Arch Conduits Flowing Partly Full

d = Depth of flow
 d_c = Critical depth
 d_m = Mean depth

D = Diameter of pipe
 A = Area of flow
 R = Hydraulic radius
 T = Top width of flow

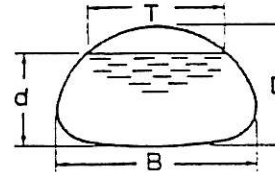

$\frac{d}{D}$ or $\frac{d_c}{D}$	$\frac{A}{BD}$	$\frac{R}{D}$	$\frac{T}{D}$	$\frac{d_m}{D}$
1.00	0.7879	0.2991	—	—
0.95	0.7762	0.3408	0.3489	2.225
0.90	0.7552	0.3549	0.4855	1.555
0.85	0.7283	0.3622	0.5848	1.245
0.80	0.6970	0.3649	0.6637	1.0503
0.75	0.6621	0.3639	0.7288	0.9085
0.70	0.6243	0.3595	0.7837	0.7966
0.65	0.5839	0.3520	0.8303	0.7033
0.60	0.5414	0.3415	0.8700	0.6223
0.55	0.4970	0.3282	0.9037	0.5500
0.50	0.4511	0.3120	0.9320	0.4840
0.45	0.4039	0.2928	0.9555	0.4227
0.40	0.3556	0.2705	0.9755	0.3616
0.35	0.3065	0.2451	0.9889	0.3100
0.30	0.2568	0.2162	0.9967	0.2577
0.25	0.2069	0.1839	0.9967	0.2076
0.20	0.1574	0.1484	0.9815	0.1603
0.15	0.10908	0.11022	0.9477	0.11505

Table 900-13

Hydraulic Properties of Circular/Pipe Arch Conduits Flowing Full

Source: Arkansas Highway and Transportation Department Drainage Manual

**SECTION 1000
DETENTION**

		<u>Page</u>
1000.1	INTRODUCTION	262-264
1000.2	TYPES OF DETENTION SYSTEMS	265-269
1000.3	DESIGN REQUIREMENTS	269-271
1000.4	DETENTION BASIN GENERAL DESIGN CRITERIA	271-273
1000.5	DETENTION BASIN COMPONENTS	273-277
1000.6	AESTHETICS	277
1000.7	SAFETY	277-279
1000.8	MAINTENANCE	279-281
1000.9	FLOODPLAIN/FLOODWAY POLICIES	281

SECTION 1000 DETENTION

1000.1 INTRODUCTION

Stormwater runoff and the velocity of discharge are considerably increased through development and growth in the City. Prior to the development of land, surface conditions provide a high percentage of permeability and a longer time of concentration. With the construction of buildings, parking lots, and other impermeable surfaces, permeability and the time of concentration are significantly decreased. These modifications may create harmful effects on properties downstream.

On-site detention of stormwater runoff is a method of urban storm water management. Storage, which involves collecting excess runoff before it enters the main drainage system, can often be an effective and economical means of reducing peak flow rates and mitigating problems of flooding, pollution, soil erosion, and siltation. Storage is a means to mitigate problems associated with increased runoff caused by development. Detention facilities can be used to lessen the impact of peak flows on downstream property, and for the improvement of water quality. This section outlines strategies to determine detention options and the best alternatives to detention when applicable.

In The City of Bryant, the preferable method of storage is on-site detention. The main purpose of an on-site detention facility is to store the excess storm runoff associated with an increased watershed imperviousness and discharge this excess at a rate similar to the runoff rate from the watershed with pre-developed conditions.

The detention basin is the most widely used measure for controlling peak discharges from urbanizing areas. Basins can be designed to fit a variety of sites and can incorporate multiple-outlet spillways to meet requirements for multi-frequency control of flow. Measures other than a detention basin, such as underground storage pipes, infiltration trenches or porous pavement may be preferred in some locations. Any device selected, however, should be assessed as to its cost, function, maintenance requirements (frequency and type), safety and impact on downstream peak flows.

Potential advantages and disadvantages of on-site detention basin options should be considered by the designer in the early stages of development. Discharge rates and outflow velocities are regulated to conform to the capacities and physical characteristics of downstream drainage systems. Energy dissipation and flow attenuation resulting from on-site storage can reduce soil erosion and pollutant loading. By controlling release flows, the impacts of the pollutant loading of stored runoff on receiving water quality can be minimized.

1000.1.1 On-Site and Regional Detention

Depending upon ownership of the site and the area tributary to a detention site, two types of detention are defined: (1) on-site, and (2) off-site or regional. Onsite detention is defined as the privately owned and generally privately maintained facility which serves

the developing area in question. Regional detention, also generally referred to as off-site detention, is normally publicly owned and maintained and generally is part of a planned park system or greenbelt area serving a larger portion of the basin. The importance of regional detention is the ability to assure that the facility will be more likely maintained and will normally function more efficiently than several small interdependent systems.

The ability of on-site or regional detention to reduce flood peaks in the local drainage ways has been recognized by the City of Bryant, and detention is therefore required in the watershed, unless the proposed system will connect to an existing system with a 100-year flood capacity.

1000.1.2 Alternatives to On-Site Detention

Where on-site detention is deemed inappropriate due to local topographical or other physical conditions, alternate methods for accommodating increases in stormwater runoff may be permitted. Any alternate method shall be approved in writing by the City Engineer prior to its consideration. The methods may include.

1. Off-site or Regional Detention. Large regional facilities serving a number of developments are generally preferable to small on-site facilities serving only one subdivision or a single office complex.
2. In-lieu monetary contributions except when:
 - a. Existing flooding occurs downstream from the development, or
 - b. If the proposed development will cause downstream flooding.
3. An owner may contribute to the cost of a regional detention site(s) or improvements to downstream conveyances in lieu of constructing on-site detention. However, the basin master plan must include downstream storage identified for “in lieu of” payments in place of on-site detention, or the Developer must adequately demonstrate that “in lieu of” downstream storage will mitigate the increased runoff from the development. In addition, there cannot be any direct identifiable adverse impacts on downstream properties. The “in-lieu fee” contribution shall be based upon an amount of \$10,000 per acre-foot of stormwater storage. The acceptance of an “in lieu fee” is totally at the discretion of the City Engineer.
4. Subject to requirements for these DESIGN CRITERIA and the SMO, existing downstream conveyance system(s) may be improved to compensate for increased flows when approved or required by the City Engineer.

1000.1.3 Regional Stormwater Management Program

The Regional Stormwater Management Program (RSMP) provides for the planning, design and construction of regional drainage improvements to prevent flooding caused by increased runoff from developments, using in lieu fees paid by the owners of the contributing developments.

City ordinances require proposed developments to mitigate the effects of increased stormwater runoff leaving their sites. On site stormwater detention ponds were and still are the primary method used to meet these requirements. However, studies have established that a system of numerous small ponds, designed for individual sites, may provide only minimal flood protection when evaluated on a watershed wide basis. In addition, regular and effective maintenance of on site ponds is a major economic issue. Although they reduce peak flood flows immediately downstream, on site ponds can change the overall timing of flood flow movement through the watershed to the extent of possibly increasing peak flood flows at points further downstream. The City recognizes the limited effectiveness of on site detention ponds in many situations, but also recognizes that all new developments contribute to the increased amounts of stormwater runoff in the watershed.

The City of Bryant uses a watershed wide approach to analyze potential flooding problems, identify appropriate mitigation measures, and select site locations and design criteria for regional drainage improvements. These improvements may include detention and retention ponds, waterway enlargement and channelization, and improved conveyance structures. The Regional Stormwater Management Program identifies watersheds in and around the City that are currently developing and have potential for flooding problems. Problems occur as undeveloped land is converted to impervious cover. In these watersheds, the RSMP allows developers to participate in the program instead of constructing on site controls if the proposed development will produce no identifiable adverse impact to other nearby properties due to increased runoff. An ongoing long term goal of the City of Bryant is to develop master plans for all watersheds throughout the City. These plans typically include hydrologic and hydraulic analyses, floodplain mapping, and planning for potential regional drainage improvements.

The fees charged for participation in the RSMP are non-refundable and are based upon a cost of \$10,000 per acre foot of storage as required by the regulations in this manual. The fees are deposited and interest is accrued in a dedicated fund and they are allocated for regional stormwater management improvements.

1000.1.4 ASWCC Regulations

Stormwater detention facilities constructed within The City of Bryant will generally be classified as small structures by the Arkansas Soil and Water Conservation Commission (ASWCC). Any dam or levee constructed for the purpose of storing water and under the jurisdiction of the ASWCC shall be designed in accordance with the “Rules Governing the Design and Operation of Dams” published by the ASWCC. Those facilities not subject to the criteria of the state shall be designed and constructed in accordance with the criteria presented herein.

1000.2 TYPES OF DETENTION SYSTEMS

1000.2.1 Dry Reservoirs/Wet Weather Ponds

Detention designed and built within the City of Bryant may be either wet or dry depending upon multiple-use considerations. On-site detention shall meet the performance standards of these DESIGN CRITERIA and the Stormwater Management Ordinance (SMO). Wet detention shall have adequate flow through to maintain waterlevels.

Dry reservoirs or wet weather ponds shall be designed with primary consideration given to safety, effectiveness, stability, and ease of maintenance. Maximum side slopes for grass reservoirs shall not exceed 1-foot vertical for 3-foot horizontal (3:1) unless adequate measures are included to provide for the above-noted features. In no case shall limits of maximum ponding exceed 3' depth, or be located closer than 20 feet horizontally from any building and less than 1-foot vertically below the lowest sill or floor elevation. The entire reservoir area shall be solid sodded. Any area susceptible to, or designed as, overflow by higher design intensity rainfall shall be sodded, paved or armored depending upon the overflow velocity.

1000.2.2 Permanent Lakes

Permanent lakes with fluctuating volume controls may be used as detention areas provided that the limits of maximum ponding elevations are no closer than 100-foot horizontally from any building and is greater than 2 feet below the lowest sill or floor elevation of any building.

Maximum side slopes for the fluctuating area of permanent lakes shall be 1-foot vertical to 3-feet horizontal (3:1) unless provisions are included for safety, stability, and ease of maintenance.

Special consideration is suggested regarding safety and accessibility of small children in design of permanent lakes in residential areas.

Allowances for silting during construction for a period of no less than 1 year should be incorporated into the design.

The entire fluctuating area of the permanent reservoir shall be solid sodded. Also, calculations must be provided to ensure adequate "live storage" is provided for the 100 year storm event. Any area susceptible to or designed as overflow by higher design intensity rainfall (100-year frequency) shall be sodded or paved, depending on the design velocities. A geotechnical report and stability analysis of the foundation for earthen dams shall be required by BPWD. Earthen dam structures shall be designed by a Professional Engineer and shall comply with the criteria of the Arkansas Soil and Water Conservation Commission Dam Safety Program regarding the design and operation of dams (ASWCC 1993).

1000.2.3 Underground Detention

Above ground detention is preferable however underground detention is allowed. Should underground detention be approved, the requirements are described in the following sections.

Underground detention shall be constructed using corrugated metal pipe (CMP), high density polyethylene (HDPE), reinforced concrete pipe (RCP), reinforced concrete box culvert (RCBC), or concrete vaults. The material thickness, cover, Bedding, and backfill shall be designed to withstand HS20 loading.

Access easements to the detention site shall be provided. To facilitate cleaning of the pipe segments, 3-foot diameter maintenance access ports shall be placed according to the following schedule:

Maintenance Access Requirements		
Detention Pipe Size	Maximum Spacing	Minimum Frequency
36 to 54 inches	150 feet	Every pipe segment
60 to 66 inches	200 feet	Every other pipe segment
>66 inches	200 feet	One at each end of the battery of pipes

The manholes shall be constructed in accordance with the detail on Figure III-49.

Pipe segments shall be sufficient in number, diameter, and length to provide the required minimum storage volume for the 100-year design. As an option, the 10-year design can be stored in the pipe segment and the difference for the 100-year stored above the pipe in an open space detention or in a parking lot detention. The minimum diameter of the pipe segments shall be 36 inches to allow cleaning.

The pipe segments shall be placed side by side and connected at both ends by elbow tee fittings or bulkheads at the outlet. The pipe segments shall be continuously sloped at a minimum of 0.25% to the outlet. Manholes for maintenance access shall be placed in the tee fittings and in the straight segments of the pipe, when required.

Permanent buildings or structures shall not be placed above the underground detention. Pavement is allowed above underground detention.

The outlet from the underground detention shall consist of a short (maximum 25 feet) length(s) of HDPE, CMP or RCP with an 18-inch minimum diameter. A two-pipe outlet may be required to control both design frequencies. The invert of the lowest outlet pipe shall be set at the lowest point in the detention pipes. The outlet pipe(s) shall discharge into a standard manhole or into a drainage way with erosion protection provided.

1000.2.4 Parking Lots

Detention is permitted in parking lots to a maximum depth of 6 inches. In no case shall the maximum limit of ponding be designed closer than 10 feet from a building unless waterproofing of the building and pedestrian accessibility are properly documented and approved. The minimum freeboard and the maximum ponding elevation to the lowest sill or floor elevation shall be 2 feet.

Parking lot detention shall be accomplished within parking areas only, and shall not be allowed within drives or primary pedestrian paths.

Where a weir and a small diameter outlet through a curb are used, the size and shape are dependent on the discharge/storage requirements. A minimum pipe size of 3-inch diameter is recommended.

To assure that the detention facility performs as designed, maintenance access shall be provided. The outlet shall be designed to minimize unauthorized modifications which effect function. Any repaving of the parking lot shall be evaluated for impact on volume and release rates and are subject to approval by the City Engineer.

All parking lot detention areas shall have a minimum of two signs posted identifying the detention pond area. The signs shall have a minimum area of 1.5 square feet and contain the following message:

“WARNING”

“This area is a stormwater detention pond and is subject to periodic flooding to a depth of (provide design depth for 25-year or 100-year storm, whichever is the design flood.)”

Any suitable materials and geometry of the sign are permissible, subject to approval by the City Engineer.

1000.2.5 Small Detention Areas

Special attention must be given to the design of outlet structures for controlling runoff from rooftops, parking lots, and small on-site swales. Because runoff volumes from such areas are small, the required outlets are also small, which increases the potential for plugging by debris. Also, because of the multi-purpose nature of these small on-site control facilities, the outlet must release temporarily stored water in a reasonable amount of time. As an example, parking lots should drain relatively fast and not be a nuisance.

Since the detained water may occasionally cause an inconvenience to those using the land for its intended purposes, the temptation may exist to modify or eliminate the on-site detention by changing the outlet. Design of parking lot grading to minimize people/water conflicts and to recognize pedestrian movement needs and patterns can reduce unauthorized facility modifications.

Proper location and protection of outlets can reduce these problems. Manufactured outlets that are more difficult to alter can be used to protect roof drains. Manufactured

grates located on the surface discourage tampering of parking lot and swale outlets placed above ground. These grates also keep the outlets clear of debris and preserve their hydraulic capability even when the grates are partially plugged. Grated inlets are also debris catchers and may be plugged when they are most needed; accordingly, the maintenance of grates should be planned where grate usage is unavoidable. The outlet facilities should be accessible and located where their maintenance needs are easily noticed, so that the public will be involved in the maintenance process. Regular maintenance of parking lots and other normally dry public detention areas should assure debris removal, especially removal of paper, plastics, and gravel or rocks.

1000.2.6 Retention Basins

In certain instances, such as when the existing development runoff from a watershed would exceed the capacity of the existing downstream facilities, retention basins (i.e., no outlet or with a release at the capacity of the downstream facilities) for the storm runoff may be required by the City Engineer.

Retention storage is stormwater runoff that is retained in an impoundment until such time that it can be safely released into a receiving stream. When the City Engineer determines that stormwater retention must be employed for a specific development, the facility shall be designed using the following criteria.

1. The minimum retention volume shall equal the runoff from a 100-year storm of 24-hour duration. No credit shall be taken for infiltration in establishing the minimum volume.
2. An overflow section shall be provided for the detention facility that will protect embankments from overflow resulting from a 100-year storm when the pond is full and the tributary area is fully developed.
3. Side slopes shall not be steeper than 4:1.
4. A minimum freeboard of 1 foot shall be provided above the maximum retention volume water surface.
5. The applicant must evaluate or assess the impacts of the retention facility on local groundwater levels and the potential for damage to nearby properties.
6. A slow release will be permitted of 0.25 cfs/acre or less if the small flows will be conveyed to a major drainage way
7. The use of retention does not relieve the land developer from making permanent detention improvements on his property as a condition of subdivision approval.
8. A drainage maintenance easement shall be dedicated to ensure that emergency maintenance and access can be legally provided to keep the

facility operable. This easement may be vacated when the retention pond function is no longer needed.

9. A maintenance plan must be provided which details mowing, removal of sediment, debris and other requirements.
10. Acceptable alternatives to these requirements may include:
 - a. Agreement among landowners wherein historic flow rates are exceeded by upstream landowners and will be accepted by downstream landowners. Such agreements are subject to review by the City Engineer.
 - b. The developer providing off-site drainage improvements to convey stormwater at historic rates to an acceptable outfall point.

1000.2.7 Other Methods

Other methods of detention such as seepage pits, french drains, etc., are discouraged. If other methods are proposed, proper documentation of soil data, percolation, geological features, etc., will be required for review and consideration.

1000.3 DESIGN REQUIREMENTS

1000.3.1 General

Criteria for differential runoff and detention guidelines are established in this manual in an attempt to decrease the adverse effects of development on downstream properties due to increased runoff. The criteria presented in this section shall be used in the design and evaluation of all storm runoff storage facilities in the City of Bryant. The review of all proposed development submittals will be based on the criteria presented in this section.

For site-specific runoff, the effectiveness of local detention structures can be acknowledged in the design of any on-site downstream drainage facilities, assuming that the detention facilities comply with all design criteria and that they are properly constructed and maintained.

In the case of regional detention basins, sizing of the system below the control structure shall be for the total improved peak runoff tributary to the structure, with no allowance for detention unless approved by the City Engineer.

In the event the Design Engineer desires to incorporate the flow reduction benefits of existing upstream detention ponds, the following field investigations and hydrologic analysis will be required. (Note that under no circumstances will the previously approved construction plans of the upstream pond suffice as an adequate analysis. While the responsibility of the individual site or subdivision plans rests with the Engineer of Record, any subsequent engineering analysis must assure that all the incorporated ponds work collectively.)

1. A field survey of the existing physical characteristics of both the outlet structure and ponding volume. Any departure from the original engineer's design must be accounted for. If a dual use for the detention pond exists (e.g., storage of equipment), then this too should be accounted for.

2. A comprehensive hydrologic analysis that simulates the attenuation of the contributing area ponds is required. This should not be limited to a linear additive analysis, but rather should consist of a network of hydrographs that considers incremental timing of discharge and potential coincidence of outlet peaks.

1000.3.2 Stormwater Detention Analysis Software

The City of Bryant will allow the use of the following software or an acceptable equal, when approved by the City Engineer for the analysis of stormwater detention facilities.

Pond-2

Pond-2 is a program for detention pond design. Pond-2 is included in PondPack, a package developed by Haestad Methods, where it is integrated with Quick TR-55. It estimates detention storage requirements, computes a volume rating table for any pond configuration, routes hydrographs for different return frequencies through alternative ponds, and plots the resulting inflow and outflow hydrographs.

Pond-2 automatically computes outflow rating curves for single or multi-stage outlet structures, and computes the controlling flow rate for outlets operating in series. Pond-2 handles orifices, weirs, box culverts, circular culverts, and other variables.

HEC-1

HEC-1 generates hydrographs from rainfall or snow melt, adds or diverts them, then routes them through reaches and reservoirs. HEC-1 models multiple stream and reservoir networks, and has dam failure simulation capabilities. It handles level-pool routing for reservoirs and detention ponds, and routes through stream reaches using Kinematic Wave, Muskingum, Muskinum-Cunge, Modified Puls, and other methods. HEC-1 supports five methods for computing infiltration and abstraction losses, and computes unit hydrographs using the Clark methods, Snyder method, and SCS dimensionless hydrographs.

HEC-HMS

HEC-HMS. The Hydrologic Modeling System is designed to simulate the precipitation-runoff processes of dendritic watershed systems. It is designed to be applicable in a wide range of geographic areas for solving the widest possible range of problems. This includes large river basin water supply and flood hydrology, and small urban or natural watershed runoff. Hydrographs produced by the program are used directly or in conjunction with other software for studies of water availability, urban drainage, flow forecasting, future urbanization impact, reservoir spillway design, flood damage

reduction, floodplain regulation, and systems operation. The program features a completely integrated work environment including a database, data entry utilities, computation engine, and results reporting tools. A graphical user interface allows the user seamless movement between the different parts of the program. Program functionality and appearance are the same across all supported platforms.

1000.4 DETENTION BASIN GENERAL DESIGN CRITERIA

1000.4.1 Storage Facility Location and Layout

Design flow paths to minimize potential short-circuiting by locating the inlets as far away from the outlet structure as possible. The length-to-width ratio of a basin should be at least 3:1. Baffles or backslope drains may be used to prevent short-circuiting. If topography or aesthetics require the pond to have an irregular shape, increase pond area and volume to compensate for dead spaces. It is important to reduce the velocity of incoming stormwater using riprap or other energy dissipaters.

Interaction with site utilities must be considered during preliminary design. Typical utilities include electrical, telephone, cable TV, water, sewer, natural gas, petroleum, etc. These utilities may or may not be in a dedicated utility easement, so it is always necessary to conduct a careful site survey. Detention basins (including embankments) should not be allowed over utility lines. Conversely, utility trenches should not be constructed on existing detention basin structures.

On-site detention facilities shall be located within the parcel limits of the project under consideration. No detention improvements will be permitted within public road rights-of-way or within a floodplain. Location of detention facilities immediately upstream or downstream of the project will be considered by special request if proper documentation is submitted with reference to practicality, feasibility, and proof of ownership or right-of-use of the area proposed. Conditions for general location of detention facilities are identified in the following sections.

1000.4.2 Design Storm

The primary function of detention storage is to reduce stormwater runoff from new development to the rate of runoff prior to development. This includes inflow-outflow hydrographs, return frequencies, storage volumes, depths required, and outlet features necessary to achieve the design performance objectives.

The storage volume of detention storage shall be that volume necessary to control the peak stormwater drainage release rate from a development so as not to exceed the pre-developed runoff that occurred before development for all frequencies of runoff up to and including the 100-year runoff.

Detention basins shall be designed to limit the peak rate of discharge from the basin for the 25-year and 100-year events to the predevelopment rate or a rate which will not cause an increase in flooding or channel instability downstream when considered in aggregate with ultimate watershed development and downstream drainage capacities.

Volumes of detention shall be evaluated according to the following methods:

A. Volume of detention for basins with total drainage areas less than 200 acres may be evaluated by the Modified Rational Method.

B. For basins with total drainage areas larger than 200 acres, the Design Engineer shall submit the proposed method of evaluation for the sizing of the detention or retention basin to the City Engineer. The method will be evaluated for acceptance, applicability, and reliability by the City Engineer. No detailed review for projects larger than 200 acres will be rendered before the method of evaluation of the detention or retention basin is approved.

The SNYDER procedure or the SCS procedure shall be used for the design of all detention facilities for basins have tributary areas of 200 to 2000 acres. The Modified Rational Method may be used for design of detention storage facilities having tributary areas of up to 200 acres. An approved hydrograph method may be selected for design of the detention basins having smaller tributary watersheds.

All calculations for detention facilities shall be presented to the City Engineer for review and approval. Information shall include mass curves, hydrographs, outflow structures analysis, and a storage routing analysis through the facility.

The computed hydraulic detention volume, described by a method presented in this section, shall be increased by 25% as a safety factor and to provide for sediment buildup from undeveloped and channel erosion of upstream tributary areas. The City Engineer may reduce this requirement depending on the development characteristics and stream stability of upstream tributary areas.

1000.4.3 Detention Basin Design

Stormwater detention pond outlets shall be designed to limit the peak stormwater discharge rate of the 2-, 10-, 25-, 50-, and 100-year storm frequencies after development to pre-development rates. The principal outlet will be designed to safely convey the runoff resulting from a 25 year event chance storm. A second outlet, the emergency outlet, will be designed to safely convey the runoff resulting from a 100 year event storm.

Methods for designing two-stage risers are often based on hydraulic equations for weir and orifice flow. The minimum size outlet orifice shall be 8" diameter. In two-stage riser design, the lower-stage orifice controls the more frequent event while the larger, less frequent event, is controlled jointly by both the high-stage weir and the low-stage orifice. The outlet conduit should be sufficiently large to carry the high-stage peak with the water surface in the riser being below the crest of the high-stage weir. Optimally, physical separation of multi-stage outlets will be sufficient to prevent hydraulic interference at all foreseeable operating stages.

The following steps outline the sequence for general detention basin design:

1. Compute existing (pre-development) and proposed (developed) site characteristics:
 - a. Drainage Area.
 - b. Runoff/Composite Runoff Coefficient.
 - c. Time of Concentration.
2. Determine rainfall intensity for existing conditions.
3. Compute existing peak runoff rates using the appropriate method (i.e. Modified Rational Method, TR-55, or HEC-HMS) Rational Formula, $Q = CIA$. These will be the maximum allowable release rates from the detention basin.
4. Determine inflow hydrograph per appropriate Method.
5. Determine estimated detention volume per appropriate Method.
6. Size detention basin based on estimated required volume. Develop stage-storage curve for the detention basin.
7. Size release structure based on allowable release flow. Develop stage-discharge curve for the release structure.
8. Route the inflow hydrographs (for the 2- through 100-year storms) through the detention basin using the Modified Plus Method of PondPack, HEC-1, HEC-HMS or other method approved by the City Engineer.
9. Check routed hydrographs to ensure flows do not exceed predevelopment peaks. Adjust detention basin and release structure, if necessary.

1000.5 DETENTION BASIN COMPONENTS

1000.5.1 Outlet Works

Detention facilities shall be provided with effective outlet works. Safety considerations shall be an integral part of the design of all outlet works. Plan view and sections of the structure with adequate details shall be included in the Plans.

The structure selected shall have documented evidence that it will control the 10-, 25-, 50-, and 100-year floods. Generally, the full range of frequency control is achieved by selecting the 100-year flood and an intermediate frequency, such as the 25-year flood.

To reduce maintenance, outlet structures should be designed with no moving parts such as manually or electronically operated gates or flap gates.

Outlets should be designed with large openings, compatible with the depth-outflow curve desired and with water quality, safety, and aesthetic objectives. Outlets should also be designed to deter damage from debris or vandalism.

Outlets that are protected by a trash rack may accumulate trash during and between storm events. To facilitate outlet operation and maintenance, trash racks should be curved or inclined so that debris tends to ride up as the water level rises. Such a design generally leaves the rack clear, allows for easier cleaning and ensures proper functioning of outlet..

The discharge end of the outlet structure can cause erosion if not properly stabilized. The high velocity outflow can be controlled by adequate size riprap on the back slope and downstream channel to reduce erosion potential. Deep toe walls to resist scour (undercutting) should also be provided.

All portions of the outlet structure must be accessible to vehicles, equipment, and personnel both between and during storm events. This includes the floor of the basin as well as ramps to points above the upstream and downstream sides of the outlet structure.

1000.5.2 Overflow Spillways

A spillway structure shall be designed as a relief structure that works in conjunction with a separate control structure. While the control structure is designed for the 25 year storm event, the spillway shall be designed for the 100 + year storm event. Spillways may be constructed of reinforced concrete, grouted rip rap, grass lined or other approved armored surface, so long as the material is capable of withstanding the anticipated flow velocities, and will protect the surface from erosion.

The overflow opening or spillway shall be designed to accept the total peak runoff of the improved tributary area and acceptable percentages of blockage (50%) shall be incorporated into the design of the outlet structure.

1000.5.3 Grading

Slopes on earthen embankments shall not be steeper than 3:1. The slopes shall be such to maintain slope stability and accessibility for maintenance. All earthen slopes shall be covered with topsoil and revegetated with grass. For grassed detention facilities, the minimum bottom slope shall be 0.5% measured perpendicular to the concrete trickle channel. Slopes may be permitted to have greater than 3:1 slopes, not to exceed 1.5:1, when the slope is protected with rip rap or armored.

1000.5.4 Embankment Protection

Whenever a detention pond uses an embankment to contain water, the embankment shall be protected from catastrophic failure due to overtopping. Overtopping can occur when the pond outlets become obstructed or when a larger flood than the design condition occurs. Failure protection for the embankment may be provided in the form of a heavy embedded riprap layer on the entire downstream face of the embankment or a separate emergency spillway having a minimum capacity of the required spillway design flood

(i.e., 50% of the Probable Maximum Flood (PMF) or the 500-year flood, whichever is greater). Structures shall not be permitted in the path of the emergency spillway or overflow. The invert of the emergency spillway should be at or above the 100-year water surface.

1000.5.5 Freeboard

A minimum of one (1) foot of freeboard shall be added to the design water surface elevation. Backwater computations for runoff entering detention basins shall assume a starting elevation based on a compatible storm. Settlement of fill material should be considered when determining freeboard. It is the responsibility of the developer to determine if additional freeboard is necessary. The City Engineer reserves the right to require additional freeboard if deemed necessary for safety or maintenance considerations. The design storm shall pass through the outlet without overtopping the structure.

1000.5.6 Trickle Channel

All grassed bottom detention ponds shall include a concrete trickle channel or equivalent performing materials design. Longitudinal slopes shall be selected to achieve a minimum flow velocity of 2 fps.

The benefits of trickle channels are: (1) to protect edges of channel from erosion, (2) to provide for easier maintenance of channel vegetation by confining the flow and by maintaining grade, (3) by providing for a positive drainage path to lower the local groundwater table, and (4) to control sedimentation.

1000.5.7 Outlet Configuration

Detention pond outlet configurations come in many different styles. We will address two types of outlets in this section however the design engineer is allowed to select other options. One style outlet consists of a grated drop inlet, outlet pipe, and an overflow weir in the pond embankment. The outlet is to control flood frequencies from the 2-year to the 100-year.

By selecting an intermediate frequency, such as the 25-year flood, the full range of frequency control is generally achieved. It is the responsibility of the Engineer to verify the required frequency control.

The minimum pipe size for the outlet is 18-inch diameter where a drop inlet is used to discharge to a storm sewer or drainage way.

The control for the 25-year discharge should generally be at the throat of the outlet pipe under the head of water. The grate must be designed to pass the 25-year flow with a minimum of 50% blockage (i.e., twice the 25-year flow). Since the minimum size of the outlet pipe is 18 inches, then a control orifice plate at the entrance of the pipe may be required to control the discharge of the design flow. Other outlet configurations will be allowed provided they meet the requirement of the permitted release rates at the required

volume and include proper provisions for maintenance and reliability. The outlet shall be designed to minimize unauthorized modifications which affect proper function.

The difference between the 100-year discharge and the surcharged discharge on the 25-year outlet is released by the overflow weir or spillway. If sufficient pond depth is available, the drop inlet and the grate can be replaced by a depressed inlet with a headwall and trash rack. Depression of the inlet is required to reduce nuisance backup of flow into the pond during trickle flows. The maximum trash rack opening dimension shall be equal to the minimum opening in the orifice plate.

Another outlet option consists of a drop inlet with an orifice controlled inlet for the 25-year discharge and a crest overflow and pipe inlet control for the 100-year discharge. The control for the 25-year discharge generally occurs at the orifice opening for the head.

The control for the 100-year discharge occurs at the throat of the outlet pipe as shown. However, the difference between the 100-year and 25-year discharge must pass over the weir and therefore the weir must be of adequate length. The effective weir length (L) occurs for three sides of the box. To ensure the 100-year control occurs at the throat of the outlet pipe, a 50% increase in the required weir length is recommended. In addition, the outlet pipe must have an adequate slope to ensure throat control in the pipe.

1000.5.8 Vegetation

All open space detention areas shall be revegetated by either irrigated Bermuda sod or natural dry-land grasses.

1000.5.9 Easements

All open space detention areas shall include an easement or dedicated right-of-way for the purpose of obtaining access from a public ROW and for maintenance activities.

Drainage easements shall be a minimum 10' width, or wider as deemed necessary by the City Engineer.

1000.5.10 Other Design Elements

A substantial percentage of embankment failures are due to inadequate outlet works design and construction, classified as "structural failures". Consequently, the Design Engineer is reminded to direct special attention to the following:

1. Avoid potential piping of water along the outside of the outlet conduits by using cutoff or anti-seep collars, careful material selection, and good compaction around the conduit.
2. Minimize the number of conduits through the embankment.
3. Minimize the potential for leaky joints within the embankment.

4. Do not use thin walled conduit or flexible pipe through the embankment.
5. Where reasonable, design the pipe to operate under little or no internal water pressure.
6. Provide a safety factor in outlet work openings to account for debris collection and design to minimize debris migration to the outlet.
7. Do not depend upon human intervention during a storm runoff event.
8. Do not operate gates or other controls during a storm runoff event.

1000.6 AESTHETICS

To change the public perception of drainage facilities and to demonstrate that stormwater management programs do provide multiple benefits, the following aesthetic goals are required:

1. To achieve a park-like appearance, as much as possible, without adding appreciably to the maintenance effort.
2. To enhance visual aesthetics by providing plantings and placement of trees, evergreens, shrubs, rock gardens, railroad ties, picnic areas, playgrounds.
3. To encourage multi-use with an emphasis on recreational uses.

A visual amenity consistent with the neighborhood and coupled with multi-use potentials related to recreation can create benefits beyond those related specifically to the hydraulic function. Detention facilities in The City of Bryant must be environmentally sound and compatible with the neighborhood and, where feasible, multi-use should be incorporated into the design.

Detention storage areas, for the most part, are physical storage areas with an embankment, outlet works, and emergency spillway. These typically range anywhere from 1,000 square feet in area to many acres. Opportunities exist to enhance the appearance. Desirable conditions can be achieved through careful design and positioning of the structure, as well as through landscaping. Creative designs, integrated with innovative landscaping, also enhance the appearance of the outlet and pond and often are less expensive.

If an emergency spillway will carry water, on the average, less than once every 25 or 100 years, the potential for enhancing the appearance of the spillway by landscaping and/or recreational use should be assessed. As long as its flow capacity will not be impeded, aesthetic improvements to the emergency spillway will be appreciated by the public.

1000.7 SAFETY

When considering safety as it relates to stormwater detention storage facilities, there are far too many possible variations to name them all. However, there are two distinct areas of concern that should always be addressed in addition to the many other possibilities.

1. Protection of the public, particularly children.
2. Protection against catastrophic failure.

Detention basins shall be designed to protect the safety of any children or adults coming in contact with the system during runoff events. Safety of storm water drainage system components is always a principal design criteria. Following are some safety measures that should be considered:

- a. The use of fencing around detention basins may be avoided by incorporating other safety features into the design of the facilities. However, certain extreme cases may require the use of fences to protect the public.
- b. The shorelines of all detention basins at 100-year capacity shall be as level as practicable to prevent accidental falls into the basin and for stability and ease of maintenance.
- c. The sideslopes of the banks of detention basins shall not be steeper than 3H:1V.
- d. All detention basins shall have a level safety ledge extending three (3) feet into the basin from the shoreline and two (2) feet below the normal water depth.
- e. Velocities throughout the drainage system shall be controlled to safe levels taking into consideration rates and depths of flow.

There are obviously many other considerations concerning safety issues such as safety measures implemented during construction and maintenance. The primary focus of this section is to draw attention to the general subject, and prompt the designer to consider all possibilities that may be of consequence or unique to his/her particular project.

With regard to children, it is necessary to assume that they will attempt to play in the area while unattended. This can become an even greater concern when detention is located in a residential area or near a school. Some safety considerations that relate more specifically to children are as follows:

- a. Maintain minimum depths to deter the possibility of accidental drowning.
- b. Flatten slopes to avoid steep embankments that can trap a person in the pond in the event they lose their footing. Flattened slopes will also allow safer maneuvering of lawn tractors and other maintenance equipment.
- c. Rough surfaces on the slopes allow stable a foothold to avoid falling in, and to afford traction for an easy escape. This is the purpose for not allowing synthetic liners that become very slippery when wet.
- d. Fencing or thorny shrubs will help deter access to the pond and structures.
- e. Warning signs will help to notify of potential risks.

Velocities, along with inlet and outlet works is another safety risk that merits consideration. If a person becomes trapped in a pond, minimal velocities will provide a better opportunity for the person to escape from the pond, as well as provide an improved function of the system. Inlet openings should be sized small enough to not allow a person to pass through, or they should otherwise be protected with a screen or grate. Manhole lids and other removable fixtures should be secured to deter tampering or removal.

With regard to catastrophic failure, properly designed embankments and structures are far less prone to failure. Failures can often be attributed to oversights, calculation errors and improper construction. A good understanding of existing and imported soils, in combination with placement and compaction is necessary. Construction of keyways, clay cores and anti-seep collars are critical to deter seepage and undermining. A properly designed outlet structure and spillway with adequate freeboard should avoid overtopping, un-controlled runoff and downstream flooding problems. Proper surface protection such as rip rap, armor and solid sodding will avoid failures caused by erosion. Routine maintenance will assure an efficient working system that will deter possible future problems.

Each project is unique and requires its own individual consideration concerning safety. The issues that were mentioned are certainly critical considerations, but many others can exist. Safety becomes an even more crucial factor when attempting to incorporate recreational facilities into the design. It is the responsibility of the design engineer, contractor and owner to determine and incorporate safety measures throughout the design, construction and maintenance of all stormwater and detention facilities whether publicly or privately owned.

Outlet safety considerations include safety to the general public and to the facility itself. The outlet works create a potential hazard when in operation due to the possibility of a person being carried into the opening. Grating or trash racks are often used; however a person can be forced against the grate or trash rack with substantial pressure, preventing escape.

Low entrance velocities at the trash rack are recommended. Fencing or other effective measures should be provided to deter people from potentially entering hazardous areas. Alternative measures include education, site grading, signing, planting of thorny shrubs, and grading for “safety ledges” along the pond perimeter.

Outlet works can be designed to reduce the hazard to the public where heavy recreational use is anticipated. For instance, a vertical riser of concrete, timber, or steel can have a series of openings of 12 inches or less from top to bottom with sufficient total area to cause low velocity at the entrances, if compatible with hydraulic requirements. The top of such risers can be grated, or even closed. In some instances the outlet works can be fenced. Appropriate signing is sometimes used to warn the public of the safety hazards involved at the outlet works.

1000.8 MAINTENANCE

Maintenance of the detention facility is an integral part of a program for the entire drainage system. The responsibility for maintenance rests with the OWNER of the facility (except where the City Engineer has agreed to maintain a facility), whether it is a rooftop, parking lot, or surface storage facility. The City Engineer has the authority to inspect or review private maintenance actions to ensure that private maintenance is being provided. Funding for maintenance, whether public or private, must be assured.

Maintainability of detention ponds should receive particular attention during design. Recognizing the life cycle costs of these facilities, long-term maintenance costs are inevitable and can be minimized only by sensitive consideration and treatment during the design of a detention facility.

A detention pond and its outlet works should be relatively maintenance free. Maintenance is facilitated by good equipment, access for inspection, cleaning, mowing, repair and ultimately reconstruction. Maintenance considerations must be an integral part of the design process.

Detention facilities, when required, are to be built in conjunction with storm sewer installation and/or grading. Since these facilities are intended to control increased runoff, they normally must be partially or fully operational soon after clearing of the vegetation. Silt and debris connected with early construction shall be removed periodically from the detention area and control structure to maintain the facility's storage capacity and function.

Maintenance of detention facilities is a continuous responsibility of the owner or property owners association. At a minimum it involves removal of sediment from the basin outlet control structure. Additional maintenance responsibilities include:

1. Major dirt and mud removal
2. Outlet cleaning
3. Mowing
4. Herbicide spraying (in strict conformance with the City's policies and procedures)
5. Litter control
6. Routine inspections

The responsibility of maintenance of the detention facilities and single-lot development projects shall remain with the general contractor until final inspection of the development is performed and approved, and a legal occupancy permit is issued. After legal occupancy of the project, the maintenance of detention facilities shall be vested with the owner of the detention pond.

Access and maintenance roads for detention facilities shall be provided for the purpose of removing sediment and debris and for general repair of the facilities. The access shall include a right-of-way at least 20-feet wide, and an all weather maintenance access road for vehicular traffic. The maximum profile grade of the road shall be 10%. Road alignment should permit movement of vehicles and equipment to service the facilities.

Where the roadway is subject to flooding, adequate protection against scour is required to protect against the 25 year storm event.

Storage reservoirs with a permanent water surface shall be provided with a low level outlet to drain the reservoir for sediment removal and other maintenance requirements. To facilitate sediment removal from all types of reservoirs, access to the bottom shall be provided.

1000.8.1 Mosquito Control

Mosquito control shall be incorporated into the maintenance plan.

1000.8.2 Ownership of Stormwater Detention Ponds

Ownership of stormwater detention ponds in the City of Bryant shall be vested in the property owner unless the basin is declared a regional facility by the City Engineer.

1000.9 FLOODPLAIN/FLOODWAY POLICIES

In no case will a detention facility be approved that is situated partially or totally within a delineated floodplain or floodway, unless specifically approved in writing by the City Engineer and acknowledged by a FEMA representative.

**SECTION 1100
SEDIMENT & EROSION CONTROL**

		<u>Page</u>
1101	INTRODUCTION	283
1102	CONTROL OF EROSION FROM CONSTRUCTION ACTIVITIES.	283-285
1103	SOIL LOSS	285-292
1104	CREATING A STORMWATER POLLUTION PREVENTION PLAN	293-305
1105	STANDARDS FOR STRUCTURAL PRACTICES	306-369

SECTION 1100 SEDIMENT AND EROSION CONTROL

1101 INTRODUCTION

A primary key to reducing sediment is stopping erosion at its source. This section will specifically focus on identifying BMP's best suited for erosion control at its source. Another important aspect of erosion and sediment control addressed in this section is keeping clean water clean. Ignoring this leads to the unnecessary pollution of our waterways. Another area addressed within this section assists the designer estimate how to size detention/debris basins, based upon amounts of sediment/debris carried by flood events. These amounts of sediment are derived from sediment eroded from watersheds. The gross erosion depends on the source of sediments in terms of upland erosion, gully erosion, and local stream bank and BPWD erosion. Upland erosion generally constitutes the primary source of sediment; other sources of gross erosion, such as mass wasting or bank erosion and gully erosion should be estimated separately by calculating the volume of sediment scoured through lateral migration of the stream and the upstream migration of headcuts. In relatively stable fluvial systems, the analysis of sediment sources and yield focus on upland erosion from rainfall and snowmelt (JULIEN, 1995). For watershed basins having defined channels, potential sediment supply from stream bank and BPWD erosion can be estimated using a sediment transport equation. The total sediment yield is then the sum of the sediment supply from upland erosion and the sediment supply from stream bank and BPWD erosion.

1102 CONTROL OF EROSION FROM CONSTRUCTION ACTIVITIES

1102.1 The Erosion and Sediment Control Plan

Erosion and Sediment Control Plans will be included in the Stormwater Management Plan. The Erosion and Sediment Control Plan is a plan for controlling erosion and sediment during construction in compliance with the laws, ordinances, and these standards. This plan shall be a part of the total site development plan and describes all the steps necessary, including scheduling, to assure erosion and sediment control during all phases of construction including final stabilization.

Planning for sediment control should begin with the conceptual plan and its preparation. Such features as soils and topography should be considered for the conceptual plan as well as any requirements for sediment control or storm water management.

Planning for erosion and sediment control should also begin with first-hand knowledge of the site by the designer. The plan shall be based on a sufficiently accurate topographic map that reflects the existing topography and site conditions. Adjacent areas affecting the site or affected by the site and its development shall be shown on the plans in sufficient detail to accomplish the need. Examples of this would be areas draining onto

the site or areas where storm runoff leaves the site and travels to a stream or drainage system.

The Erosion and Sediment Control Plan will consist of the best selection of erosion control practices and sediment-trapping facilities, in conjunction with an appropriate schedule, to accomplish an adequate level of control. Particular attention must be given to concentrated flows of water, either to prevent its occurrence or to provide conveyance devices according to the Standards to prevent "major" or "gross" erosion. Sediment-trapping devices will usually be required at all points of egress of sediment-laden water. The plan must include permanent structures for conveying storm runoff, final site stabilization, removal of temporary sediment control features such as sediment basins, and finally, stabilization of the sites where temporary features were removed. Plans showing improvements or construction to be done outside the property line for the site will generally not be approved unless the plan is accompanied by an appropriate legal easement for the area in which the work is to be done.

The standardization of erosion and sediment control plans makes them easier to study and review. The List of Standard Symbols was developed to facilitate plan review. The symbols should be bold and easily identified on the plans.

Unless otherwise approved, one of the following scales shall be used for the detailed sediment control plans for urban development sites: 1" = 20', 1" = 30', 1" = 40', or 1" = 50'. The contour interval for these plans shall be 2 feet or smaller.

The Erosion and Sediment Control Plan shall include the existing and proposed topography. Existing topography can be either from actual field survey obtained from approved photogrammetric methods or from information obtained from responsible agencies. No proposed slopes will exceed 2H:1V. All slopes steeper than 3H:1V will require low-maintenance stabilization.

The existing and proposed improvements shall be shown on the Erosion and Sediment Control Plan and will include all buildings, roads, storm drains, etc. Proposed removal or alterations of existing facilities shall be indicated on the plan.

1102.2 Sediment Control Practices

All sediment control practices must be identified on the Erosion and Sediment Control Plan. These practices will be shown in sufficient detail to facilitate implementation. All permanent erosion and sediment control structures will be labeled on the plan as PERMANENT. All temporary stabilization practices will be labeled on the plan as TEMPORARY. The location and methods of stabilization will be indicated on the Plan.

A schedule, or sequence, of operations will be included on the plan. Special emphasis will be placed on the scheduled start of clearing and/or grading, sequence of installation of sediment control and storm water management facilities, duration of exposure, and the scheduled start and completion dates of stabilization measures (both temporary and permanent).

1102.3 Drainage Plan. A Drainage Plan shall be provided as part of the Stormwater Management Plan.

1103 SOIL LOSS

1103.1 Types of Methods for Predicting Sediment Yield

Numerous mathematical approaches can be used to determine sediment yield from natural or disturbed land surfaces. One category of mathematical models is the “black box,” or lumped parameter model. Another category is based on regression equations as typified by the Universal Soil Loss Equation (USLE), to be discussed later. Both types interpret input-output relations using simplified forms that may or may not have physical significance. Processes related to the movement of water and sediment through the watershed are grouped into coefficients, such as in the rational formula for estimating peak discharge, i.e., $Q = CIA$, where Q is peak discharge, I is rainfall input, A is the drainage area, and C is the runoff coefficient that represents all hydrologic processes. Although lumped parameter and regression methods are often used, the parameters may not accurately represent observable physical characteristics. Another disadvantage is that some methods do not consider the physical environment as dynamic with respect to time and location.

Another approach is through the use of stochastic models. If rainfall events, watershed response, and runoff events are stochastic, i.e., probabilistic in nature, the processes of sediment yield are also stochastic. However, stochastic models are difficult to apply (SHEN and LI, 1976) and do not readily show the response of a watershed undergoing changes as a result of various land use activities. Most hypotheses used in stochastic models have not been tested by field data. Knowledge in applying stochastic models to sediment yield from watersheds is still primitive.

The physical process simulation model is another type of method in which the governing processes controlling sediment yield are formulated and analyzed separately to provide model sensitivity to land management alternatives. These models are used to estimate or predict sediment yields resulting from natural or disturbed watershed lands, taking into account important physical processes such as raindrop splash, overland flow erosion, channel erosion, and movement of different sediment size fractions. However, these models are quite complex and are beyond the scope of this MANUAL.

One important aspect of model development and operation is data. Without adequate data, the testing and verification of models for application to field situations may produce erroneous results unrepresentative of actual conditions. An understanding of model operations and the controlling physical processes aids in the detection of erroneous data. Development or prediction methods, keeping physical processes and data needs in the forefront, can produce realistic, accurate methods for estimating sediment yield from watersheds.

1103.2 The Universal Soil Loss Equation

The USLE is the most widely used equation for empirical estimation of gross erosion from upland areas (SMITH and WISCHMEIER, 1957). This equation has been used on cropland and rangeland to estimate long-term (10 years or more) average annual soil losses from sheet and rill erosion with varying degrees of success, depending on the amount of quantitative data available to estimate factor values (WISCHMEIER, 1973). The USLE equation is:

$$A = RKLSCP \quad (1101)$$

The USLE equation is defined by six (6) factors. The designer should consult the Soil Conservation Service's Technical Release No. 51¹ and USDA Handbook No. 537, for the proper tables and figures. The Universal Soil Loss Equation is defined by Equation 1100-1.

$$A = R K L S C P \quad (1100-1)$$

where:

A	=	sediment yield, in tons per acre per year
R	=	rainfall factor, R = 300 for The City of Bryant, Arkansas
K	=	soil erodibility factor
L	=	slope length factor
S	=	slope gradient factor
C	=	cropping management factor
P	=	erosion control practice factor

where A is the estimated annual soil loss in tons per acre, R is the rainfall erosivity factor, K is the soil-erodibility factor, LS is the topographic factor, C is the cropping factor, and P is a supporting conservative practices factor. SMITH and WISCHMEIER (1957), MEYER and MONKE (1965), and WISCHMEIER (1973) provide detailed descriptions of this equation.

The rainfall-erosivity factor R can be calculated for each storm. The annual rainfall erosion factor in the United States decreases from a value exceeding 500 near the Gulf of Mexico to values under 100 in the northern states and in the Rockies.

Soil erodibility factor K was found by WISCHMEIER, et al. (1971) to be a function of percent of silt, percent of coarse sand, soil structure, permeability of soil, and percent of organic matter.

The topographic factor LS was defined as the ratio of soil loss from any slope and length to soil loss from a 72.6 foot plot length at a 9 percent slope, with all other conditions the same. This factor can be approximated from the field runoff length X_r in feet and surface slope S_o in feet per feet. Where the runoff length was defined as the distance from the point of overland flow origin to the point where either slope decreases to the extent that deposition begins or runoff water enters a well-defined channel (SMITH and

WISCHMEIER, 1957). The effect of the runoff length on soil loss is primarily a result of increased potential due to greater accumulation of runoff on the longer slopes.

The cropping-management factor C was defined as the ratio of soil loss from land cropped under specific conditions to corresponding loss from tilled, continuously fallow ground. WISCHMEIER (1972) presented a method including graphical aids for determining the cropping-management factor. This factor, ranging from approximately 0 to 1.0, is the product of the effect of canopy cover (CI), effect of mulch or close-growing vegetation in direct contact with the soil surface (CII), and tillage and residual effect of the land use (CIII).

The conservation practice factor P accounts for the effect of conservation practices such as contouring, strip cropping and terracing on erosion. This factor has no significance for wildland areas and can be set at 1.0.

The USLE is used with a sediment delivery ratio, SDR to estimate the amount of sediment delivered by channels at a point downstream. This ratio takes into account the storage and deposition of sediment within a watershed, and is found to be highly dependent on the drainage area of the upstream watershed.

This method was used by the U. S. FOREST SERVICE (1980) and many others, and was compared with other predictive methods by ALLEN (1981). ALLEN indicated that the sediment delivery ratio is oversimplified and unreliable. WISCHMEIER (1971) cautioned that large errors can occur if the R factor is used to predict soil loss on a storm basis.

1103.3 Revised Universal Soil Loss Equation (RUSLE)

The RUSLE is an improved automated version of the original USLE technology that has been used for erosion prediction technology since 1965. The equation remains the same as USLE; which is

$$A = R * K * L * S * C * P$$

Where

A = computed spatial average soil loss and temporal average soil loss per unit of area, expressed in the units selected for K and for the period selected for R. In practice, these are usually selected so that A is expressed in tons / acre / year.

R = rainfall – runoff erosivity factor – the rainfall erosion index plus a factor for any significant runoff from snowmelt.

K = soil erodibility factor – the soil loss rate per erosion index unit for a specified soil as measured on a standard plot, which is defined as a 72.6 ft. (22.1 m.) length of uniform 9% slope in continuous clean-tilled fallow.

L = slope length factor – the ratio of soil loss from the field slope length to soil loss from a 72.6 ft. length under identical conditions.

S = slope steepness factor – the ratio of soil loss from the field slope gradient to soil loss at 9% slope under otherwise identical conditions.

C = cover-management factor – the ratio of soil loss from an area with specified cover and management to soil loss from an identical area in tilled continuous fallow.

P = support practice factor – the ratio of soil loss with a support practice like contouring, stripcropping, or terracing to soil loss with straight-row farming up and down the slope.

RUSLE is an erosion model designed to predict the longtime average annual soil loss (A) carried by runoff from specific field slopes in specified cropping and management systems as well as from rangeland. Widespread use has substantiated the usefulness and validity of RUSLE for this purpose. It is also applicable to nonagricultural conditions such as construction sites.

RUSLE users need to be aware that A (in addition to being a longtime average annual soil loss) is the average loss over a field and that the losses at various parts of the field may differ greatly from one another. On a long uniform slope, the loss from the top part of the slope is much lower than the slope average, and the loss near the bottom of the slope is considerably higher. For instance, a 360 ft. uniform slope that averages 20 t/ac/yr will have an average of less than 7 t/ac/yr loss on the first 40 ft. but over 29 t/ac/yr on that last 40 ft. If the slope steepness changes within that length, the variation can be even greater. This suggests that even if a field soil loss is held to “T”, soil loss on some portion of the slope may reach or exceed 2T, even when the ephemeral gully and other type of erosion that are not estimated by RUSLE are ignored. These higher than average rates generally occur at the same locations year after year, so erosion on an appreciable part of the field may be occurring at a seriously excessive rate.

With appropriate selection of its factor value, RUSLE will compute the average soil loss for a multicrop system, for a particular crop year in a rotation, or for a particular crop stage period within a crop year. Erosion variables change considerably from storm to storm about their means. But the effects of the random fluctuations such as those associated with annual storm variability in rainfall-runoff erosivity (R) and the seasonal variability of the cover-management factor (C) tend to average out over extended periods. Because of the unpredictable short-time fluctuations in the levels of influential variables, however, present soil-loss equations are substantially less accurate for the prediction of specific events than for the prediction of longtime averages.

USLE has also been used for estimating soil loss from disturbed forested conditions. RUSLE does not address this particular application.

Arkansas Soil and Water Conservation Commission has published a handbook, which contains guidelines and procedures for using the Revised Universal Soil Loss Equation

(RUSLE) in Arkansas. The City of Bryant adopts this handbook for calculating soil loss in The City of Bryant. Please contact Arkansas Soil and Water Conservation Commission to acquire a copy of this handbook.

1103.4 Revised Universal Soil Loss Equation 2 (RUSLE2)

RUSLE2 solves a set of mathematical equations to compute estimates for soil loss. It accomplishes this with a computer program. The user inputs variables into the computer program that describes the project site. The computer program computes values for rill-interrill (sheet and rill) erosion on the overland flow portion of a landscape. The user describes the site conditions using the RUSLE2 computer program.

1103.4.1 Rill-Interrill Erosion

The overland flow portion of the landscape is that part of landscape where runoff is uniformly spread over the soil surface. This flow occurs on the landscape upstream of where runoff becomes concentrated in well-defined flow channels. An overland flow path can be traced from the origin of overland flow to where the runoff enters a concentrated flow channel, which ends the overland flow path. The origin of overland flow is at the top of any ridge where the runoff flows one way on one side of the ridge and the opposite way on the other side of the ridge.

Raindrops impacting exposed soils detach soil particles that then move overland creating sediment.

Overland flow is the primary mechanism for transporting sediment. Overland flow when combined with raindrop impact causes erosion that eventually leads to formation of mini-channels, which are commonly referred to as rills. The area between these mini-channels is referred to as interrill areas and detachment of soils is caused by rain impact in these spaces while flow causes detachment in the min-channels (rills). This is also called rill erosion.

The City of Bryant Stormwater Management Plan targets both rill and interrill erosion. The City of Bryant expect all developments control soil erosion in order to protect the waters of the City. A computer program like RUSLE2 is designed to ensure that this expectation is met while helping develop an economic and logical approach to erosion and sediment control practice.

Rill-interrill erosion can not only cause impacts on the project site but those impacts can reach beyond the limits of the project. Off-site sedimentation can created problems for storm drainage systems by reducing their capacity. It can also cause waterways to become discolored and degraded.

The City of Bryant does not expect a project to implement erosion and sediment control practices that are not necessary causing undue expense. However The City of Bryant does expect the project to implement practices that ensure the present and future quality of the water bodies of the city.

1103.4.2 Application

RUSLE2 is an excellent tool to help identify the best erosion and sediment control practices for a project site. Climate, soil, topography and land use are factors that effect erosion rate. Rain intensity affects soil erosion and varies across the country. Varying grades across a project create varying degrees of erosion. The same can be said for varying grades across the city. Steep embankments create greater erosion than flat slopes. Soils erode at varying rates as well. As one selects a project site one should consider the soils because different soils will require different treatments in order to control erosion rate.

Land users use RUSLE2 to help select the best erosion and sediment control practices for their project. City officials use the program to determine whether land users have selected the proper erosion and sediment controls.

RUSLE2 assist in estimating erosion rate for a set of erosion control options. The developer can evaluate different erosion control practices efficiently with the program. They can then select the best practices based on their assets or project conditions. Generally, the practice that gives the lowest estimated erosion rate is considered the best one for the project however site conditions may dictate otherwise.

1103.4.3 The Main Factors of RUSLE2

RUSLE2 considers the four primary factors that affect soil erosion by rainfall in combination with overland flow. These factors are: climate, soil, topography, and land use condition. Fundamentally, erosion rate by water is determined by erosivity of the erosive agents raindrop impact and surface runoff as it relates to the resistance of the soil to erosion. Erosion rate is controlled in one or both of two ways: reduce erosivity (i.e., the erosive forces applied to the soil by raindrops and surface flow) or increase the soil's resistance capability to the erosive forces being applied.

Climate (weather)

Rainfall events produce the erosive agents of raindrop impact and overland flow. How much it rains (or rainfall amount) and how hard it rains (the rainfall intensity) are the two primary characteristics of rainfall that determine its erosivity. Rainfall erosivity will vary by location. Much more rainfall occurs at a high intensity at New Orleans, LA than at Phoenix, AZ. Therefore, location determines erosivity.

Temperature has an indirect affect on erosion. Temperature, along with soil moisture content, determines the decomposition rate of vegetative and organic materials (such as mulches, erosion control blankets) that are used to control erosion. The foremost important method of reducing erosion is to keep the soil surface protected with cover. Mulches and erosion control blankets don't last as long in hot, moist climates as in colder, drier climates. Decomposition is dependant on both temperature and moisture. Either one can limit the decomposition process.

Weather will vary during the year. For example, late spring and early summer months are when the most erosive rains occur in The City of Bryant. The soil should be protected as much as possible during this time frame. Therefore, timing of land disturbing activities is an erosion control consideration, one that can be easily evaluated using the RUSLE2 program.

RUSLE2 uses an erosivity index known as the R-value to describe erosivity at a location. RUSLE2 also considers how erosivity will vary during the year by utilizing an R-value for each month. The erosivity index for a single storm is known as EI, which is the product of a storm's energy (as related to storm amount and intensity) and maximum 30-minute intensity rate. The R-value is an average annual summation of these individual storm EI values.

Soil

Soils vary in their inherent susceptibility to erosion. Soil susceptibility to erosion can be described as the opposite of resistance to erosion. This susceptibility is known as soil erodibility. The index for soil erodibility used by the RUSLE2 program is known as the K-value. Values for soil erodibility are empirically derived by measuring soil loss from a plot 72.6 ft (22.1 m) long, 9% steep, and maintained in a continuous fallow (no vegetation), seedBPWD condition that is periodically tilled up and down slope. This plot condition is known as the RUSLE2 unit plot.

The USDA-Natural Resources Conservation Service (NRCS) has assigned K-values for most “non-disturbed” soils types across the US. For example, if you are applying the RUSLE2 program to cropland, an NRCS soil survey provides a K-value that you can use.

K-values cannot be predetermined and cataloged for highly disturbed soils. Fortunately you do not have to set up a unit plot to establish your own erosion measurements to determine K-values for highly disturbed lands. The RUSLE2 program can estimate soil erodibility values for highly disturbed soils, but in most cases you have to collect soil samples to determine input values to make the estimates.

The single most important variable affecting soil erodibility is soil texture. Soil texture refers to the distribution of the primary particles of clay, silt, and sand particles in the soil. Every soil has a different soil textural class based on the percent of sand, silt and clay in them.

Soils high in clay content have low erodibility K-values because these soils have strong internal forces that resist detachment caused by raindrops and surface flows. Soils high in sand also have low soil erodibility K-values but for a different reason. These soils have high infiltration rates, which results in reduced runoff and thus reduced erosion. Soils high in silt are the most erodible soils. Particles are easily detached from these soils, which in turn produce greater runoff than clays and sandy soils.

Topography

The RUSLE2 program is applicable to an overland flow path. Usually a single representative overland flow path is chosen to represent the site. However, the RUSLE2 program allows for representation of several paths for particular areas of the site. Therefore each path's erosion can be computed.

The three important topographic factors that determine erosion are average steepness of the overland flow path, length of the path, and profile shape of the flow path (i.e., how steepness varies along the path). Steep slopes generate greater erosion rates than flatter slopes. As the overland flow path increases so does erosion. The accumulation of runoff as the path increases on steep slopes generates erosion and sediment runoff. This is not the case on flat slopes.

Slope (profile) shape is the other major factor. Uniform slope is assumed in RUSLE2 generally. A uniform slope is one where the steepness, soil, and cover-management conditions are the same everywhere along the slope. A convex slope is one where steepness increases along the slope. Erosion rates at the end of a convex slope can be extremely high. A concave slope is one where the steepness decreases along the slope. If the steepness at the end of a concave slope is sufficiently flat, deposition can occur, which reduces the amount of sediment leaving the slope. Complex slopes are slopes made up of concave and convex sections. Variation of soil and land use conditions along the slope requires that the slope be treated as a complex slope when applying RUSLE2. Thus, in terms of RUSLE2, complexity refers to more than just slope shape.

Land use conditions

Land use conditions refer to the cover-management practice on the slope as well as supporting practices that might be applied in combination with the cover-management condition. Cover-management refers to what is taking place to the soil. Is the soil bare, is it covered by mulch, or is it covered by vegetation. Is the soil rough or smooth, has it been mechanically disturbed and if so when. Does the soil contain live and dead roots. Supporting practices include contouring, which directs the runoff around the slope to reduce its erosivity, strips and barriers that slow the runoff and induce deposition, diversions/terraces that cut the overland flow path length to reduce runoff erosivity, sediment basins that trap sediment, and subsurface drains that reduce runoff amount and rate and thus runoff erosivity.

RUSLE2 represents cover-management conditions by considering how canopy, ground cover, surface roughness, time since last mechanical disturbance and live and dead plant roots and incorporated biomass affect erosion. These variables are referred to as management sub factors in the program.

1104 CREATING A STORM WATER POLLUTION PREVENTION PLAN

1104.1 REQUIREMENTS

Under the NPDES General Permits for Stormwater Discharge from Construction Sites, EPA requires the development and implementation of a stormwater pollution prevention plan (SWPPP). A SWPPP for construction is designed to reduce pollution at the construction site, before it can cause environmental problems. Many of the practices and measures required for the SWPPP represent standard operating procedures at many construction sites. Stormwater management controls, erosion and sediment controls, inspection and maintenance have all been used at a number of construction sites.

A requirement of the Stormwater Management Ordinance is to develop a Storm Water Pollution Prevention Plan (SWPPP) before construction activities begin. The SWPPP shall be complete before submitting the Notice of Intent (NOI). The following checklist provides a format, as well as the minimum required guidelines for SWPPP preparation. You will be able to develop a SWPPP that will normally fulfill the requirements of the Arkansas Department of Environmental Quality by following this guide.

A step-by-step process for ensuring that pollutants are not making their way into the stormwater discharges from a project consists of six major phases. The six major phases of the process are (1) site evaluation and design development, (2) assessment, (3) control selection and plan design, (4) certification and notification, (5) construction/implementation, and (6) final stabilization/termination.

1104.2 Site Evaluation and Design Development Phase. The first phase in preparing a SWPPP for a construction project is to define the characteristics of the site and the type of construction that will be occurring. This phase is broken down into four requirements: (a) collect site information, (b) develop site design, (c) describe construction activity, and (d) prepare pollution prevention site map.

1104.2.1 Collect site information

- A. Existing conditions site map
- B. Soils information
- C. Runoff water quality
- D. Name of receiving stream / water
- E. Rainfall data

1104.2.2 Develop Site Plan Design

- A. Disturb the smallest vegetated area possible
- B. Keep the amount of cut and fill to a minimum
- C. Limit impacts to sensitive areas such as:

1. Steep and / or unstable slopes
2. Surface waters, including wetlands
3. Areas with soil is likely to erode
4. Existing drainage channels

1104.2.3 Describe Construction Activity

- A. Describe purpose or goal of construction project
- B. List soil disturbing activities necessary to complete the project

1104.2.4 Prepare Pollution Prevention Site Map

- A. Approximate slopes after grading
- B. Indicate areas of soil disturbance
- C. Indicate drainage patterns

1104.3 Assessment Phase. Once the characteristics of the site and the construction have been defined, the next phase in developing the SWPPP is to measure the size of the land disturbance and estimate the impact the project will have on stormwater runoff from the site based on information collected in the Site Evaluation and Design Development Phase. Three things should be done to assess the project: (a) measure the site area, (b) measure the drainage areas, and (c) calculate the runoff coefficient.

1104.3.1 Measure site area

- A. Indicate the total site area and the area which will be disturbed

1104.3.2 Determine the Drainage Area

- A. Measure the size of each drainage basins for each point where concentrated flow will leave the site.
- B. Use the calculated concentrated flow to determine the appropriate sediment control measures.

1104.3.3 Calculate the Runoff Coefficient

- A. Estimate the runoff coefficient of the site after construction is complete.

1104.4 Control Selection/Plan Design Phase. After you have collected the information and made measurements, the next phase is to design a plan to prevent and control pollution of stormwater runoff from your construction site. To complete the SWPPP, (a) review and incorporate State and local requirements, (b) select erosion and sediment controls, (c) select other controls, (d) select stormwater management controls, (e) indicate the location of controls in the site map, (f) prepare an inspection and maintenance plan, (g) prepare a description of controls, and (h) prepare a sequence of major activities.

1104.4.1 Review and incorporate State and local requirements

- A. Prior to designing the SWPPP, you must first check for other agency SWPPP requirements and comply with them.
- B. Permittees shall incorporate all applicable requirements specified in State or local sediment and erosion control plans or permits, or storm water management plans or permits. This should include requirements such as:
 - City ordinances
 - City grading permit requirements

1104.4.2 Select erosion and sediment controls

- A. Stabilization measures for disturbed areas
- B. Structural controls to divert runoff and remove sediments
- C. Erosion and sediment controls can include temporary or permanent measures

1104.4.3 Select other controls

- A. Proper waste disposal
- B. Control of offsite vehicle tracking
- C. Compliance with applicable State or local waste disposal
- D. Sanitary sewer or septic system regulations
- E. Control of allowable non-storm water discharges

1104.4.4 Select storm water management controls

- A. Storm water detention structures (including wet ponds)
- B. Storm water retention structures
- C. Open vegetated swales
- D. Natural depressions
- E. Infiltration measures

1104.4.5 Indicate location of controls on the site map

- A. Areas of permanent seeding
- B. Areas of sod stabilization
- C. Silt fence
- D. Straw bale barrier
- E. Earth dikes
- F. Brush barriers
- G. Drainage swales
- H. Sediment traps
- I. Pipe slope drains
- J. Level spreaders
- K. Storm drain inlet protection
- L. Reinforced soil retaining systems
- M. Gabions

- N. Temporary or permanent sediment basins
- O. Stabilized construction entrances

1104.4.6 Site map requirements

- A. Drainage patterns
- B. Approximate slopes after grading
- C. Area of soil disturbance
- D. Location of major structural and nonstructural controls
- E. Areas where stabilization practices are expected to occur
- F. Location of surface waters

1104.4.7 Prepare an inspection and maintenance plan

- A. Qualified personnel shall inspect disturbed areas of the construction site at least once every seven calendar days and within 24 hours of the end of a storm that is 0.5 inches or greater
- B. A description of procedures to maintain in good condition and effective operating condition like:
 - i. Vegetation
 - ii. Erosion and sediment control measures
 - iii. Other protective measures identified in the site plan

1104.4.8 Prepare a description of controls

- i. Describe the control
- ii. Describe the purpose
- iii. Explain why it is appropriate

1104.4.9 Prepare sequence of major activities

- A. The sequence of major activities should include a timeline for:
 - i. Construction of control measures
 - ii. Earth disturbing construction activities
 - iii. Maintenance activities for control measures in the order in which they will occur
 - iv. Down slope and side slope perimeter controls should be installed before the land disturbing activity occurs
 - v. Do not disturb an area until it is necessary for construction to proceed
 - vi. Cover or stabilize as soon as possible
- B. The sequence of major activities should include a timeline for:
 - i. Time activities to limit impact from seasonal climate changes or weather events
 - ii. Construction of infiltration measures should be delayed to the end of the project when upstream drainage areas have been stabilized

1104.5 Certification and Notification Phase. Once the site description and controls portion of the SWPPP have been prepared, you now must (a) certify the pollution prevention plan and (b) submit a Notice of Intent to ADEQ. A checklist is provided at the end of this document at Appendix A to assist evaluating whether all the required items are included in your SWPPP prior to certifying the plan or submitting a Notice of Intent.

1104.5.1 Certify the Plan

- A. Your NPDES storm water permit requires that authorized representative(s) of the operator(s) sign and certify the plan. The authorized representative(s) should be individuals at or near the top of the management chain, such as:
- The president
 - Vice-president
 - General partner, who has been delegated the authority to sign and certify this type of document

1104.5.2 Notice of Intent

- A. You are required to submit a Notice of Intent (NOI) prior to commencement of construction
- B. The NOI cannot be submitted until the SWPPP has been prepared

1104.5.3 Plan location

- A. SWPPPs for construction activities shall be maintained onsite of the activity unless the Director, or authorized representative, the operator of a large or medium MS4, or a State or local sediment and control agency requests that the plan be submitted.
- B. Permittees should keep a copy of the plan at the construction site until the site is finally stabilized
- C. Permittees are required to keep the plan, all reports and data for at least three years after the project is complete

1104.6 Construction/Implementation Phase. Once you have prepared a SWPPP and filed a Notice of Intent, you may start construction of the project upon approval by ADEQ. However, the items identified in the SWPPP must now take place: (a) implement the controls, (b) inspect and maintain the controls, (c) maintain records of construction activities, (d) update/change the plan to keep it current, (e) take proper action when there is a reportable quantity spill and (f) have plans accessible.

1104.6.1 Implement controls

- A. The controls should be constructed or applied in accordance with State or local standard specifications
- B. If there are no State or local specifications for control measures then the controls should be constructed in accordance with good engineering practices
- C. Improperly installed controls can have little or no effect and may actually increase the pollution of storm water

1104.6.2 Inspect and maintain controls

- A. Inspection should be performed at the frequency specified in the SWPPP and / or the permit
- B. The inspector should note any damage or deficiencies in the control measures in an inspection report
- C. The inspector should correct damage or deficiencies as soon as practicable after the inspection
- D. The operator should keep records of the construction activity on the site, such as:
 - Dates when major grading activities occur in a particular area
 - Dates when construction activities cease in an area
 - Dates when an area is stabilized

1104.6.3 Update / change plans

- A. SWPPPs are developed based on site-specific features and functions. Where there are changes in design, construction, operation, or maintenance, and that change will have a significant effect on the potential for discharging pollutants in storm water at a site, the SWPPP should be modified by the permittee to reflect the changes and new conditions
- B. The permittee is required to update the plan as necessary to reflect any changes onsite which may affect the potential for discharges of pollutants from the site

1104.6.4 Releases of reportable quantities

- A. If the construction site has a release of a hazardous substance or of oil in an amount which exceeds a reportable quantity (RQ) as defined at 40 CFR Part 110, 40 CFR Part 117, or 40 CFR Part 302, then the permittee shall do several things:
 - The person in charge of the site at the time of the spill shall call the National Response Center to report the spill – 800-424-8802
 - Within 14 days after the release is detected, modify the site SWPPP
 - Within 14 days of the release, submit a written description of the release to ADEQ

1104.7 Final Stabilization / Termination Phase. Operators of a construction site must continue to comply with permit conditions until: (1) they

no longer meet the definition of an operator of a construction site; or (2) the construction activity is complete, all disturbed soils have been finally stabilized, and temporary erosion and sediment controls have been or will be removed. A permittee is required to submit a Notice of Termination (NOT) to inform ADEQ that they are no longer an operator of a construction activity.

1104.7.1 Final stabilization

- A. A site can be considered finally stabilized when all soil disturbing activities at the site have been completed and a uniform perennial vegetative cover with a density of 70 percent for the unpaved areas and areas not covered by permanent structures has been established or equivalent permanent stabilization measures have been employed

1104.7.2 Notice of Termination

- A. The Notice of Termination (NOT) is the final task required to comply with the requirements of an NPDES storm water permit for a construction activity. The NOT form is sent to the permittee with the confirmation letter. Additional NOTs can be obtained by contacting the storm water staff at ADEQ.

EPA CONSTRUCTION GENERAL PERMIT REQUIREMENTS PRECONSTRUCTION CHECKLIST

Storm Water Pollution Prevention Plans

- | | | |
|----|--------------------------------|---|
| 1. | A site description, including: | |
| | ~ | The nature of the activity |
| | ~ | Intended sequence of major construction activities |
| | ~ | The total area of the site |
| | ~ | The area of the site that is expected to undergo excavation |
| | ~ | The runoff coefficient of the site after construction is complete |
| | ~ | Existing soil or storm water data |
| | ~ | A site map with: |
| | ~ | Drainage patterns |
| | ~ | Approximate slopes after major grading |
| | ~ | Area of soil disturbance |
| | ~ | Outline of areas which will not be disturbed |
| | ~ | Locations of major structural and non-structural controls |
| | ~ | Areas where stabilization practices are expected to occur |
| | ~ | Surface waters |
| | ~ | Storm water discharge locations |
| | ~ | The name of the receiving water(s) |
| 2. | A description of controls: | |
| | 2.1 | Erosion and sediment controls, including: |
| | | ~ Stabilization practices for all areas disturbed by construction |
| | | ~ Structural practices for all drainage/discharge locations |
| | 2.2 | Storm water management controls, including: |
| | | ~ Measures used to control pollutants occurring in storm water discharges after construction activities are complete |
| | | ~ Velocity dissipation devices to provide nonerosive flow conditions from the discharge point along the length of any outfall channel |
| | 2.3 | Other controls including: |
| | | ~ Waste disposal practices which prevent discharge of solid materials to waters of the U.S. |
| | | ~ Measures to minimize offsite tracking of sediments by construction vehicles |
| | | ~ Measures to ensure compliance with State or local waste disposal, sanitary sewer, or septic system regulations |
| | 2.4 | ~ Description of the timing during the construction when measures will be implemented |
| 3. | ~ | State or local requirements incorporated into the plans |
| 4. | ~ | Inspection and maintenance procedures for control measures identified in the plan |
| 5. | ~ | Identification of allowable non-storm water discharges and pollution prevention measures |
| 6. | ~ | Contractor certification |
| 7. | ~ | Plan certification |

EPA CONSTRUCTION GENERAL PERMIT REQUIREMENTS

**Storm Water Pollution Prevention Plan
Construction/Implementation Checklist**

1. Maintain Records of Construction Activities, including:
 - ~ Dates when major grading activities occur
 - ~ Dates when construction activities temporarily cease on a portion of the site
 - ~ Dates when construction activities permanently cease on a portion of the site
 - ~ Dates when stabilization measures are initiated on the site
2. Prepare Inspection Reports summarizing:
 - ~ Name of inspector
 - ~ Qualifications of inspector
 - ~ Measures/areas inspected
 - ~ Observed conditions
 - ~ Changes necessary to the SWPPP
3. Report Releases of Reportable Quantities of Oil or Hazardous Materials (if they occur):
 - ~ Notify National Response Center 800/424-8802 immediately
 - ~ Notify permitting authority in writing within 14 days
 - ~ Modify the pollution prevention plan to include:
 - the date of release
 - circumstances leading to the release
 - steps taken to prevent reoccurrence of the release
4. Modify Pollution Prevention Plan as necessary to:
 - ~ Comply with minimum permit requirements when notified by EPA that the plan does not comply
 - ~ Address a change in design, construction operation or maintenance which has an affect on the potential for discharge of pollutants
 - ~ Prevent reoccurrence of reportable quantity releases of a hazardous material or oil

EPA CONSTRUCTION GENERAL PERMIT CHECKLIST

**Storm Water Pollution Prevention Plan
Final Stabilization/Termination Checklist**

1. ~ All soil disturbing activities are complete
2. ~ Temporary erosion and sediment control measures have been removed or will be removed at an appropriate time
3. ~ All areas of the construction site not otherwise covered by a permanent pavement or structure have been stabilized with a uniform perennial vegetative cover with a density of 70% or equivalent measures have been employed

**POLLUTION PREVENTION PLAN FOR STORM WATER DISCHARGE ASSOCIATED WITH
CONSTRUCTION ACTIVITIES
EROSION AND SEDIMENT CONTROL SELECTION CHECKLIST**

INSTRUCTIONS: THIS CHECKLIST LISTS THE MINIMUM SEDIMENT EROSION CONTROL REQUIREMENTS UNDER THE USEPA GENERAL PERMIT. CHECK () EACH ITEM AND FILL IN THE BLANKS BELOW TO EVALUATE COMPLIANCE FOR EACH DRAINAGE AREA AND LOCATION. NOTE: THIS CHECKLIST WAS PREPARED FOR THE USEPA GENERAL PERMIT. REQUIREMENTS FOR STATE GENERAL PERMITS MAY VARY.

Stabilization Practices	
<input type="checkbox"/> Stabilization will be initiated on all disturbed areas where construction activity will not occur for a period of more than 21 calendar days by the 14th day after construction activity has permanently or temporarily ceased.	
Stabilization measures to be used include:	
<input type="checkbox"/> Temporary Seeding	<input type="checkbox"/> Sod Stabilization
<input type="checkbox"/> Permanent Seeding	<input type="checkbox"/> Geotextiles
<input type="checkbox"/> Mulching	<input type="checkbox"/> Other _____
Structural Practices	
<input type="checkbox"/> Flows from upstream areas will be diverted from exposed soils to the degree attainable. Measures to be used include:	
<input type="checkbox"/> Earth Dike	<input type="checkbox"/> Pipe Slope Drain
<input type="checkbox"/> Drainage Swale	<input type="checkbox"/> Other _____
<input type="checkbox"/> Interceptor Dike and Swale	
Drainage locations serving less than 10 disturbed acres	Drainage locations serving 10 or more disturbed acres
<input type="checkbox"/> Sediment controls will be installed	<input type="checkbox"/> A Sediment Basin will be installed
<input type="checkbox"/> Sediment controls include:	<input type="checkbox"/> A Sediment Basin is not attainable on the site; therefore, the following sediment controls will be installed:
<input type="checkbox"/> Sediment Basin	<input type="checkbox"/> Sediment Trap
<input type="checkbox"/> Sediment Trap	<input type="checkbox"/> Silt Fence or equivalent controls along all sideslope and downslope boundaries
<input type="checkbox"/> Silt Fence or equivalent controls along all sideslope and downslope boundaries	
Sediment Basin Runoff Storage Calculation	
_____ x 3.600 = _____	acres area draining to the sediment basin cubic feet of storage required for the basin

Storm Water Construction Permits

The size and location of the construction site determine which requirements apply. Use the flowchart and map below to determine your permitting requirements.

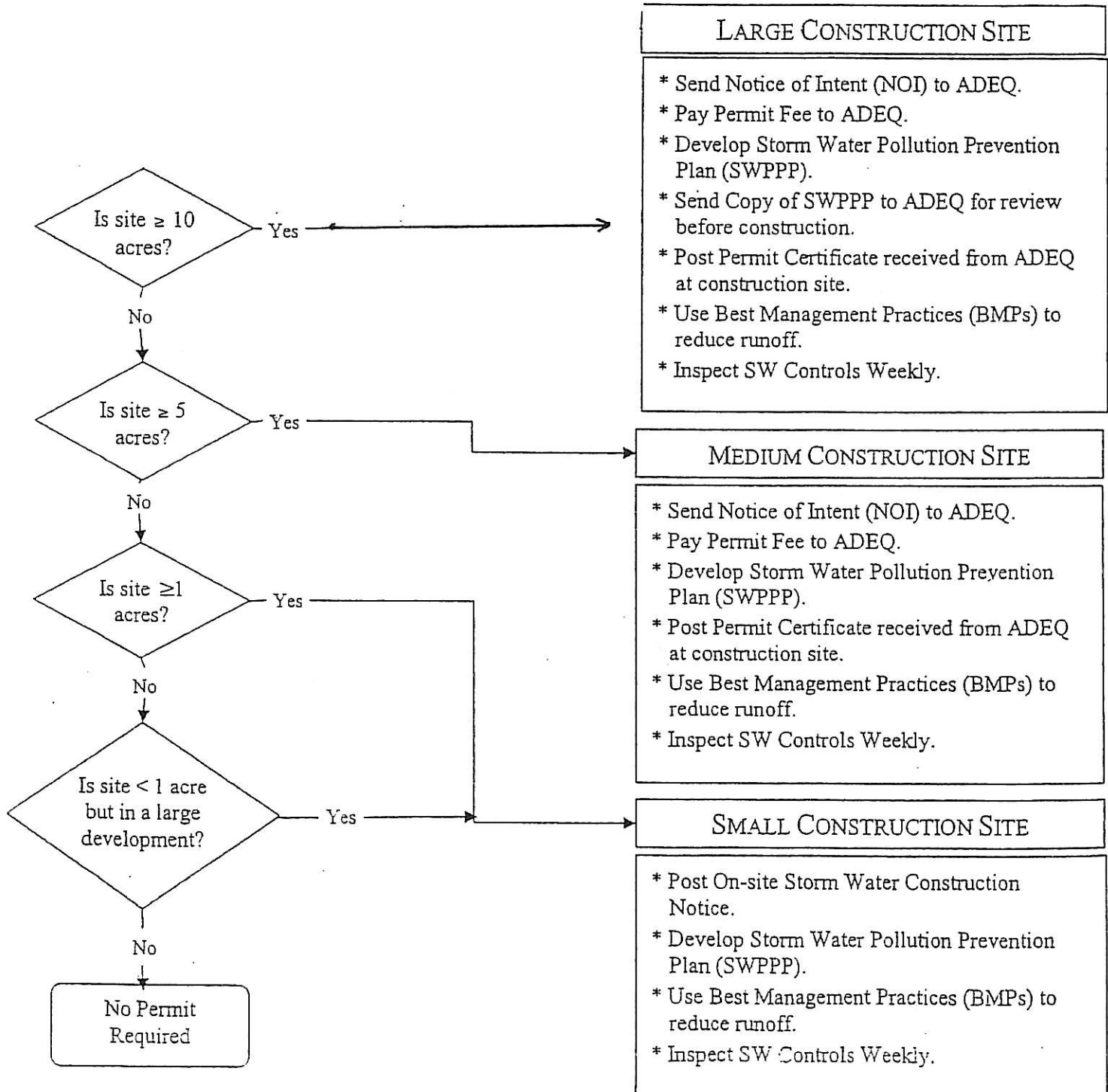

SMALL (LESS THAN 5 ACRES) CONSTRUCTION SITE NOTICE

FOR THE
Arkansas Department of Environmental Quality (ADEQ)
Storm Water Program
NPDES GENERAL PERMIT NO. ARR150000

The following information is posted in compliance with Part I.B.7.a.iv of the ADEQ General Permit Number ARR150000 for discharges of storm water runoff from small construction sites. Additional information regarding the ADEQ storm water program may be found on the internet at:

www.adeg.state.ar.us/water/branch_npdes/stormwater

Permit Number	ARR150000
Contact Name: Phone Number:	_____ _____
Project Description (Name, Location, etc.): Start Date: End Date: Total Acres:	_____ _____ _____ _____
Location of Storm Water Pollution Prevention Plan:	_____

For Construction Sites Authorized under Part I.B.6.c (Small Construction Sites Authorization) the following certification must be completed:

I _____ (Typed or Printed Name of Person Completing this Certification) certify under penalty of law that I have read and understand the eligibility requirements for claiming an authorization under Part I.B.2.a.iii of the ADEQ General Permit Number ARR150000. A storm water pollution prevention plan has been developed and implemented according to the requirements contained in Part I.B.7.a.iv of the permit. A copy of this signed notice is supplied to the operator of the MS4 if discharges enter a regulated small, medium, or large MS4 system as defined in Part II.C of the ADEQ General Permit Number ARR150000. I am aware there are significant penalties for providing false information or for conducted unauthorized discharges, including the possibility of fine and imprisonment for knowing violations.

Signature and Title

Date

1105 STANDARDS FOR STRUCTURAL PRACTICES

This section describes several control measures which are available for use in controlling erosion and sedimentation. The designer is encouraged to review sections 620, 621, 622, 623, 624, 625 and 626 of the Standard Specifications for Highway Construction (AHTD) for additional information on these control measures.

1105.1 Straw Bale Barrier (Exhibit 1100-1 and 1100-6)

Definition

A temporary sediment barrier of straw or similar material entrenched and anchored may be used to intercept sediment laden runoff from small drainage areas of disturbed soil.

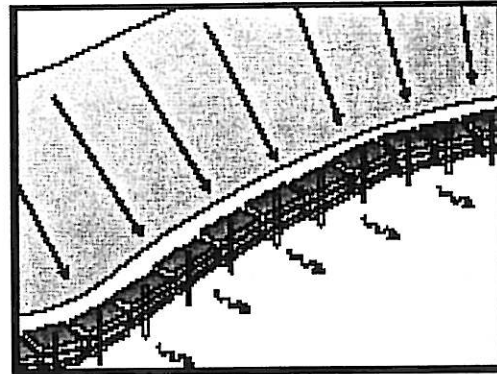

Objective

The objective of a straw bale barrier is to:

- Soil stabilization
- Sediment Control
- Tracking Control
- Wind Erosion Control

Purpose

The purpose of a straw bale barrier is to reduce velocity and effect deposition of the transported sediment load. Straw bale barriers are to be used to intercept and detain small amounts of sediment from unprotected areas of less than 1/2 acre in order to prevent sediment from leaving the site.

Application

The straw bale barrier is used:

- A. When contributing area is approximately 1/2 acre, or less.
- B. Where there is no concentration of water in a channel or other drainage way above the barrier.
- C. When erosion would occur in the form of sheet or rill erosion.
- D. When the length of slope above the straw bale dike shall not exceed 100 feet.
- E. When effectiveness is required for less than 3 months.

- F. In minor swales or ditch lines where the maximum contributing drainage area is no greater than 2 acres.
- G. Along the perimeter of a site.
- H. Along streams and channels.
- I. Below the toe of exposed and erodible slopes.
- J. Down slope of exposed soil areas.
- K. Around stockpiles.
- L. Across minor swales or ditches with small catchments.
- M. Around above grade type temporary concrete washouts
- N. Parallel to a roadway to keep sediment off paved areas.

Under no circumstances should straw barriers be constructed in live streams or in swales where there is the possibility of a washout. Straw bales must not be used on high sediment producing areas above "high risk" areas, where water concentrates, or where there would be a possibility of a washout.

Planning Considerations

Straw bale barriers have not been as effective as many users had hoped they would be. There are three major reasons for such ineffectiveness.

Straw bale barriers have been used in streams and drainage ways where high water velocities and volumes have destroyed or impaired their effectiveness. Improper placement and installation of the barriers, such as staking the bales directly to the ground with no soil seal or entrenchment, has allowed undercutting and end flow. This has resulted in additions of rather than removal of sediment from runoff waters. Finally, inadequate maintenance lowers the effectiveness of these barriers.

The thousands of straw bale barriers used annually in The City of Bryant represent sufficient expense that optimum installation procedures should be emphasized. If such procedures are carefully followed, straw bale barriers can be quite effective.

Design Criteria

A design is not required. All bales shall be placed on the contour and shall be either wire bound or nylon-string tied. Bales shall be laid with the cut edge adhering to the ground and staked in place. At least two wooden or metal stakes shall be driven through each bale and into the ground deep enough to securely anchor the bales. The first stake shall

be angled toward the previously placed bale and driven through both the first and second bale. Stakes shall be driven flush with the bale.

The possibility of piping failure shall be reduced by setting the straw bales in a trench excavated to a depth of at least four (4) inches and by firmly tamping the soil along the upstream face of the barrier.

Construction Specifications

1. Bales shall be placed in a single row, lengthwise on the contour, with ends of adjacent bales tightly abutting one another.
2. All bales shall be either wire-bound or string-tied. Straw bales shall be installed so that bindings are oriented around the sides rather than along the tops and bottoms of the bales in order to prevent deterioration of the bindings.
3. The barrier shall be entrenched and backfilled. A trench shall be excavated the width of a bale and the length of the proposed barrier to a minimum depth of 4 inches. After the bales are staked and the gaps between bales filled by wedging, the excavated soil shall be backfilled against the barrier. Backfill soil shall conform to the ground level on the downhill side and shall be built up to 4 inches against the uphill side of the barrier.
4. Each bale shall be securely anchored by at least two stakes or re-bars driven through the bale. The first stake in each bale shall be driven toward the previously laid bale to force the bales together. Stakes or re-bars shall be driven deep enough into the ground to securely anchor the bales.
5. The gaps between bales shall be filled by wedging with straw to prevent water from escaping between the bales.
6. Straw bale barriers shall be removed when they have served their usefulness, but not before the upslope areas have been permanently stabilized.

Maintenance

1. Straw bale barriers shall be inspected immediately after each rainfall and at least daily during prolonged rainfall.
2. Close attention shall be paid to the repair of damaged bales, end runs and undercutting beneath bales.
3. Necessary repairs to barriers or replacement of bales shall be accomplished promptly.
4. Sediment deposits should be removed after each rainfall. They must be removed when the level of deposition reaches approximately one-half the height of the barrier.
5. Any sediment deposits remaining in place after the straw bale barrier is no longer required shall be dressed to conform to the existing grade, prepared and seeded.

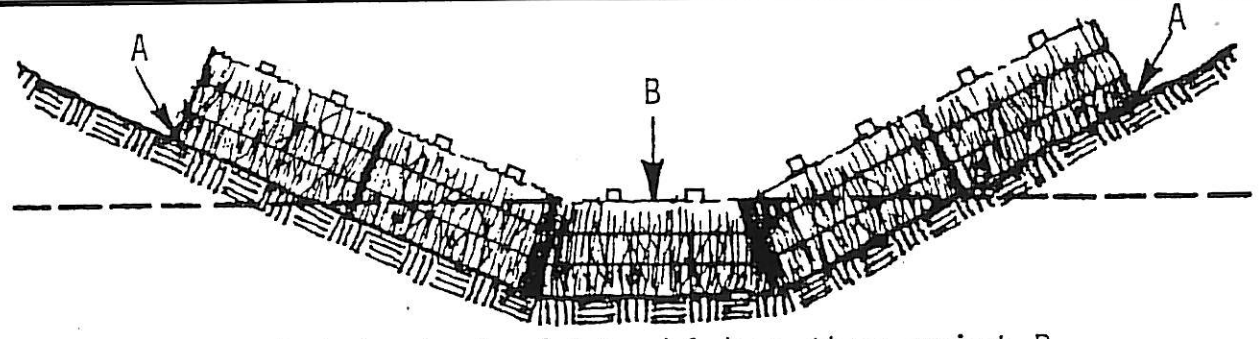

Points A should be higher than point B

1. Excavate the trench.

2. Place and stake straw bales.

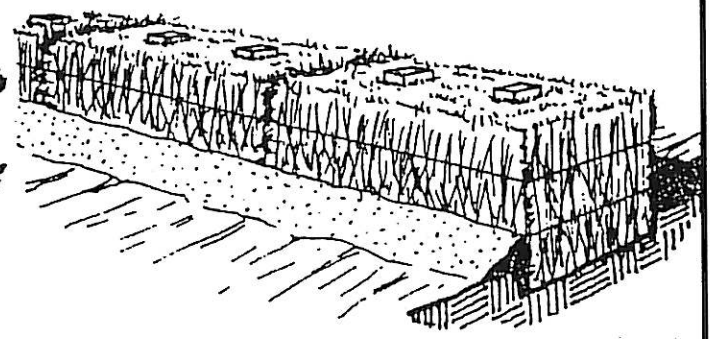
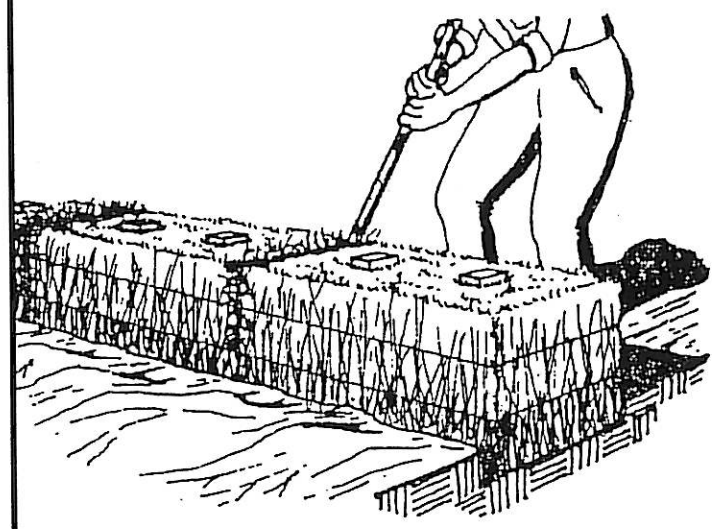
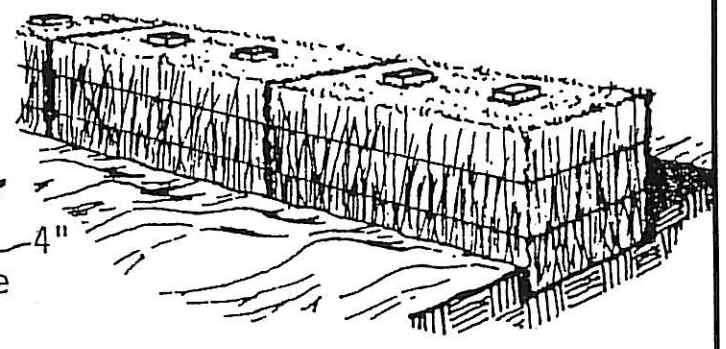
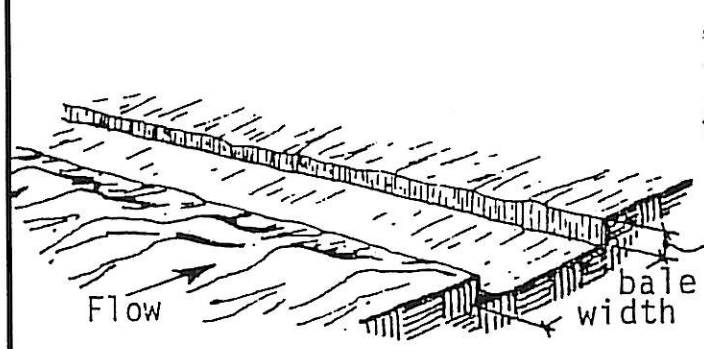

3. Wedge loose straw between bales.

4. Backfill and compact the excavated soil.

CONSTRUCTION OF A STRAW BALE BARRIER

Exhibit 1100-1

(Source: Virginia Erosion and Sediment Control Handbook)

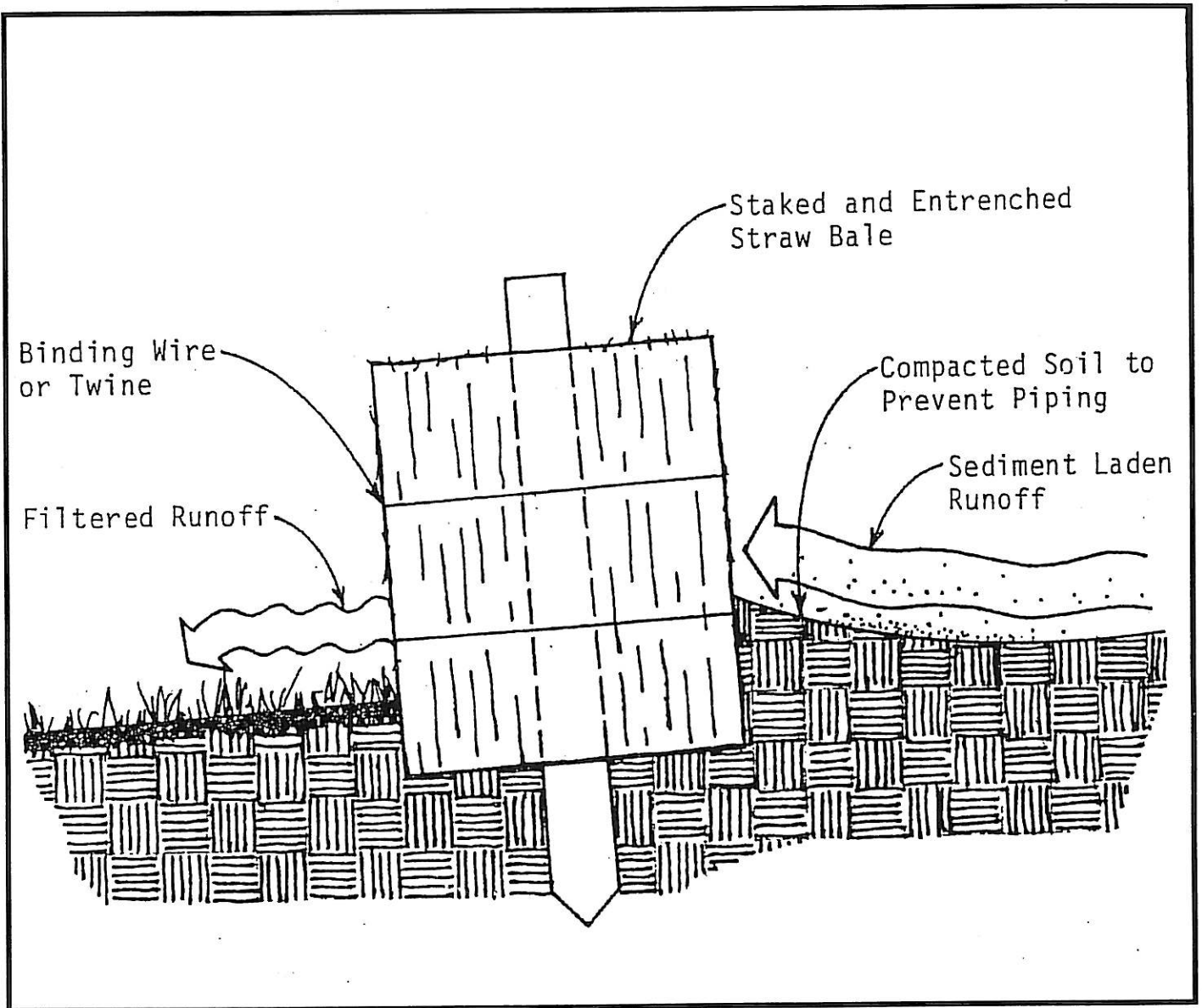
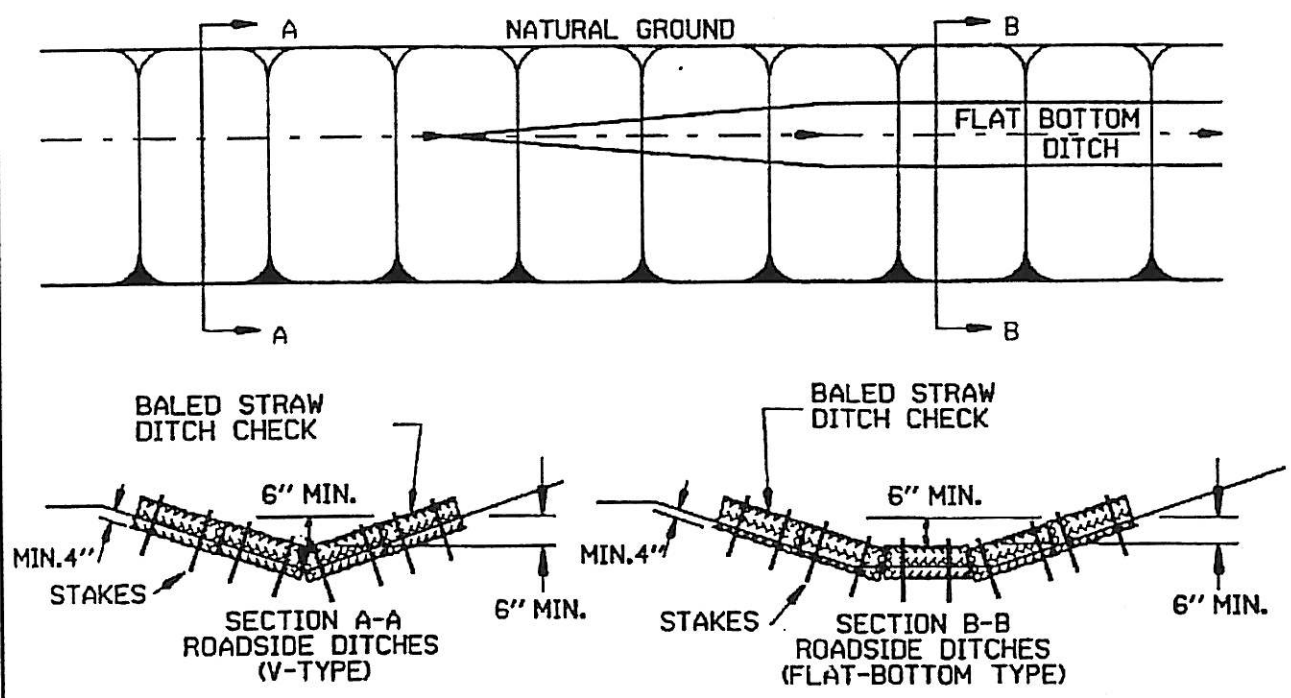

Exhibit 1100-2

(Source: Virginia Erosion and Sediment Control Handbook)

GENERAL NOTES

- 1. STRAW BALES SHALL BE INSTALLED SO THAT THE BINDINGS ARE ORIENTED AROUND THE SIDES RATHER THAN ALONG THE TOPS AND BOTTOMS OF THE BALES. THE BALES SHALL BE A MINIMUM OF 30 INCHES IN LENGTH.
- 2. STRAW BALES SHALL BE KEYED INTO SOIL A MINIMUM OF 4' AND NO GAPS SHALL BE LEFT BETWEEN BALES.



BALED STRAW DITCH CHECK (E-1)

Exhibit 1100-3

(Source: Arkansas Highway and Transportation Department Drainage Manual)

GENERAL NOTES

1. STRAW BALES SHALL BE INSTALLED SO THAT THE BINDINGS ARE ORIENTED AROUND THE SIDES RATHER THAN ALONG THE TOPS AND BOTTOMS OF THE BALES. THE BALES SHALL BE A MINIMUM OF 30 INCHES IN LENGTH.
2. NO GAPS SHALL BE LEFT BETWEEN BALES.
3. BALED STRAW FILTER BARRIERS COMPLETED AND ACCEPTED WILL BE MEASURED BY THE BALE IN PLACE AS AUTHORIZED BY THE ENGINEER AND WILL BE PAID FOR AT THE CONTRACT UNIT PRICE BID PER BALE FOR BALED STRAW DITCH CHECKS.

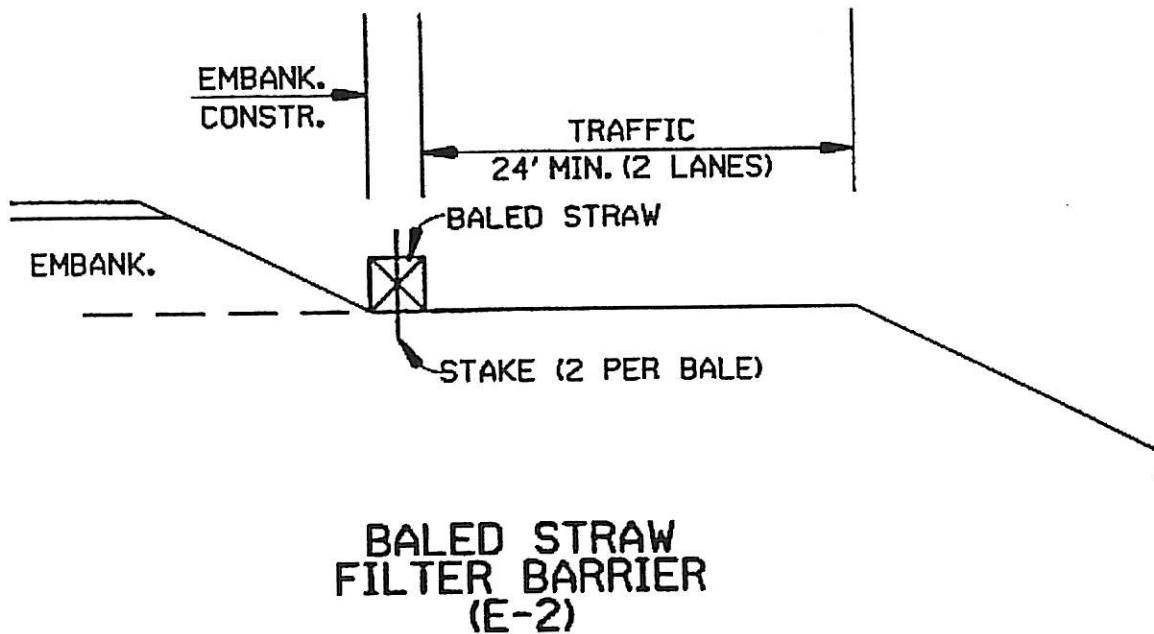

Exhibit 1100-4

(Source: Arkansas Highway and Transportation Department Drainage Manual)

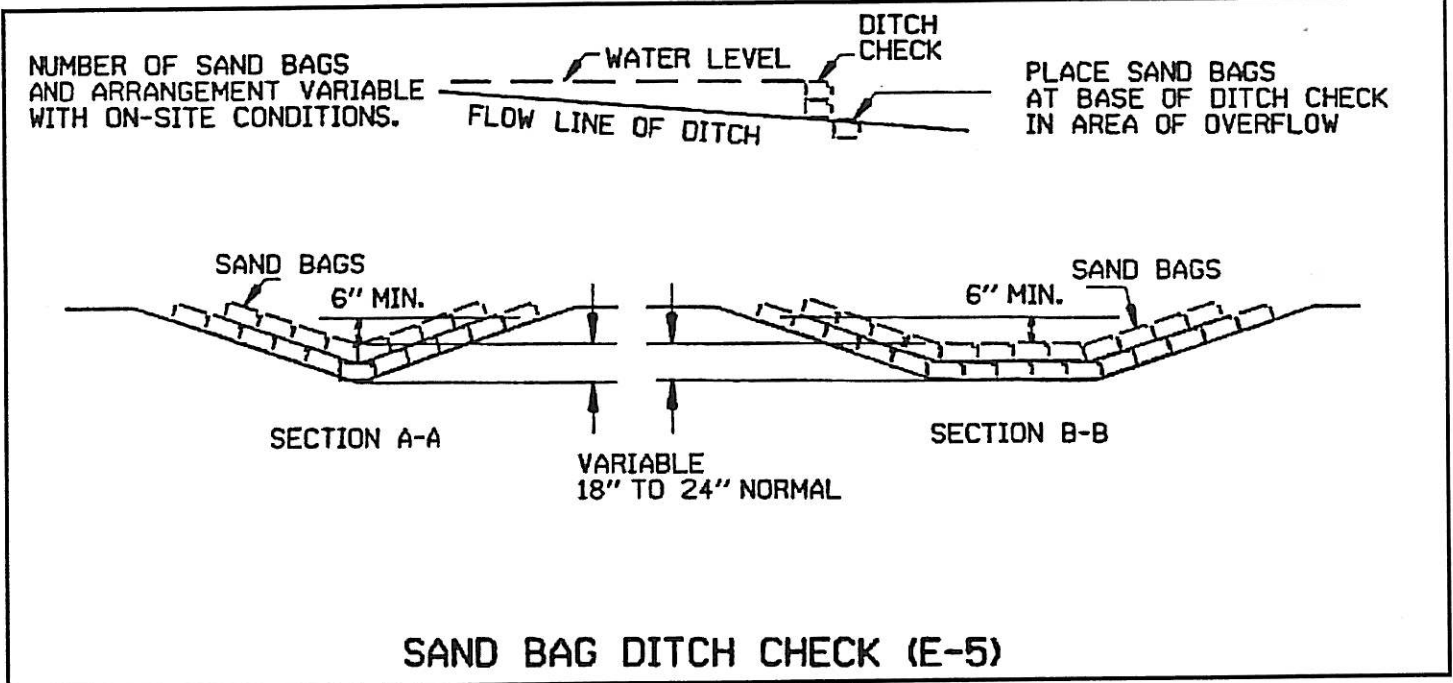

Exhibit 1100-5

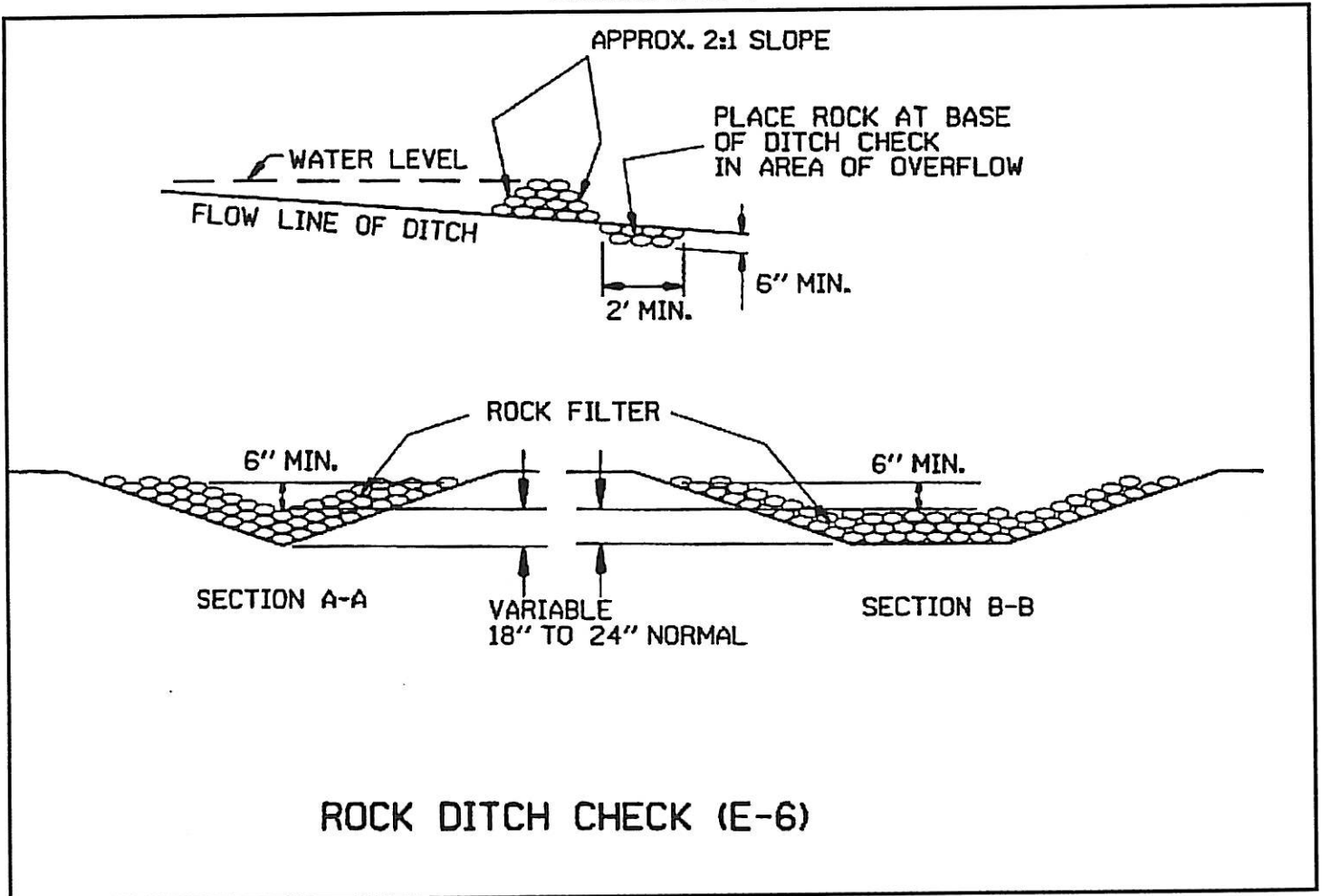

Exhibit 1100-6

(Source: Arkansas Highway and Transportation Department Drainage Manual)

1105.2 Silt Fence and Filter Barriers (Exhibit 1100-7 thru 1100-11)

Definition

A silt fence is a temporary barrier made of geotextile fabric stretched across and attached to supporting posts, wire fence and entrenched, which is water-permeable but will trap water-borne sediment from small drainage areas of disturbed soil. The filter barrier is constructed of stakes and burlap or synthetic filter fabric.

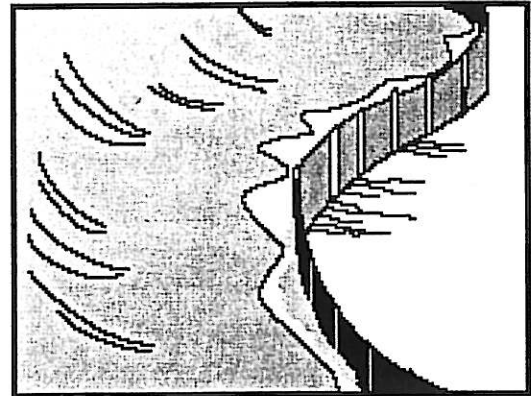

Objective

The objective of a silt fence/filter barrier is to:

- Soil stabilization
- Sediment Control
- Tracking Control
- Wind Erosion Control

Purpose

The purpose of a silt fence is to reduce runoff velocity of sheet flows and low to moderate channel flows. It also intercepts and effects deposition of transported sediment load from disturbed areas during construction operations to prevent sediment from leaving the site. Limits imposed by ultraviolet stability of the fabric will dictate the maximum period the silt fence may be used.

Application

A silt fence may be used subject to the following conditions:

- A. Maximum allowable slope lengths contributing runoff to a silt fence are listed in the Table 1100-1.

TABLE 1100-1 Silt Fence Slope Criteria

Constructed Slope	Maximum Slope Length (feet)
2H:1V	25
2.5H:1V	50
3H:1V	75
3.5H:1V	100
4H:1V	125
Flatter than 5H:1V	200

- B. Maximum drainage area for overland flow to a silt fence shall not exceed 0.5 acre per 100 feet of fence.
- C. Erosion would occur in the form of sheet and rill erosion.
- D. In minor swales or ditch lines where the maximum contributing drainage area is no greater than 2 acres. Under no circumstances should silt fences be constructed in live streams or in swales or ditch lines where flows are likely to exceed 1 cubic foot per second.
- E. Below the toe of exposed and erodible slopes.
- F. Down-slope of exposed soil areas.
- G. Around temporary stockpiles.
- H. Along streams and channels.

Planning Considerations

Silt fences can trap a much higher percentage of suspended sediments than can straw bales. Silt fences may be preferable to straw barriers in many cases. While the failure rate of silt fences is lower than that of straw barriers, there have been instances in which silt fences were improperly installed, which made them less effective than straw barriers.

Silt fences composed of a wire support fence and an attached synthetic filter fabric slow the flow rate significantly and have a higher filtering efficiency than burlap. The woven fabrics generally display higher strength than the non-woven fabrics. While all of the fabrics demonstrate very high filtering efficiencies for sandy sediments, there is considerable variation among both woven and non-woven fabrics when filtering the finer silt and clay particles.

Filter barriers are inexpensive structures composed of burlap or standard weight synthetic filter fabric stapled to wooden stakes. Flow rates through burlap filter barriers are slightly slower and filtering efficiency is significantly higher than for straw bale barriers.

Design Criteria

Design computations are not required for a silt fence design. Filter barriers shall have an expected usable life of 3 months. They are applicable in ditch lines, around drop inlets, and at temporary locations where continuous construction changes the earth contour and runoff characteristics and where low or moderate flows, which do not exceed 1 cfs are expected. Silt fences, because they have a much lower permeability than burlap filter barriers, have their applicability limited to situations in which only sheet or overland flows are expected. They normally cannot filter the volumes of water generated by channel flows. And many of the fabrics do not have sufficient structural strength to

support the weight of water ponded behind the fence line. Their expected usable life is 6 months.

Construction Specifications

Materials

1. Burlap shall be 10 ounce per square yard fabric.
2. Posts for silt fences shall be either 4-inch diameter wood or 1.33 pounds per linear foot steel with a minimum length of 6 feet. Steel posts shall have projections for fastening wire to them.
3. Stakes for filter barriers shall be 1" x 2" wood or equivalent metal with a minimum length of 3 feet.
4. Wire fence reinforcement for silt fences using standard strength filter cloth shall be a minimum of 42 inches in height, a minimum of 14 gauge and shall have a maximum mesh spacing of 6 inches.
5. The silt fence fabric shall meet the specifications in Table 1100-2. Type W fabric is a self-supported fence. Type NW is a non-woven fabric which is used in a net-reinforced fence. Either fabric may be manufactured from polyester, polypropylene or polyamide and shall be resistant to ultraviolet degradation, mildew or rot. The edges of woven fabric shall be sealed or salvaged to prevent raveling.

TABLE 1100-2 Silt Fence Fabric Criteria

Fabric Properties	Minimum Acceptable Value		Test Method
	Type W	Type NW	
Tensile Strength, lb	100	90	ASTM D4632
Elongation at Yield, %	10-40	100 Max	ASTM D4632
Trapezoidal Tear, lb	50	35	ASTM D4533
Permittivity, 1/sec	0.1	1.0	ASTM D4491
Apparent Opening Size	20-50	50-80	ASTM D4751
Ultraviolet Stability, %	80	80	ASTM D4355

Filter Barrier: This sediment barrier may be constructed using burlap or standard strength synthetic filter fabric. It is designed for low or moderated flows not exceeding 1 cfs. The filter fence shall be placed and constructed in such a manner that runoff from a disturbed upland area shall be intercepted, the sediment trapped, and the surface runoff allowed to percolate through the structure. The bottom of the fabric should be buried in a 6 inch by 6 inch trench to prevent underflow.

1. The height of a filter barrier shall be a minimum of 15 inches and shall not exceed 18 inches.
2. Burlap or standard strength synthetic filter fabric shall be purchased in a continuous roll and cut to the length of the barrier to avoid the use of joints.
3. The stakes shall be spaced a maximum of 3 feet apart at the barrier location and driven securely into the ground a minimum of 8 inches.
4. A trench shall be excavated approximately 4 inches wide and 4 inches deep along the line of stakes and upslope from the barrier.
5. The filter material shall be stapled to the wooden stakes, and 8 inches of the fabric shall be extended into the trench. Heavy duty wire staples at least 1/2 inch long shall be used. Filter material shall not be stapled to existing trees.
6. The trench shall be backfilled and the soil compacted over the filter material.
7. If a filter barrier is to be constructed across a ditch line or swale, the barrier shall be of sufficient length to eliminate end flow, and the plan configuration shall resemble an arc or horseshoe with the ends oriented upslope.
8. Filter barriers shall be removed when they have served their useful purpose, but not before the upslope area has been permanently stabilized.

Silt Fence: This sediment barrier utilizes standard strength or extra strength synthetic filter fabrics. It is designed for situations in which only sheet or overland flows are expected. All silt fences shall be placed as close to the contour as possible. The bottom of the fabric should be buried in a 6 inch by 6 inch trench to prevent underflow.

1. The height of a silt fence shall not exceed 36 inches.
2. The filter fabric shall be purchased in a continuous roll cut to the length of the barrier to avoid the use of joints. When joints are necessary, filter cloth shall be spliced together only at a support post, with a minimum 6-inch overlap, and securely sealed.
3. Posts shall be spaced a maximum of 10 feet apart at the barrier location and driven securely into the ground a minimum of 12 inches. When extra strength fabric is used without the wire support fence, post spacing shall not exceed 6 feet.
4. A trench shall be excavated approximately 4 inches wide and 4 inches deep along the line of posts and upslope from the barrier.
5. When standard strength filter fabric is used, a wire mesh support fence shall be fastened securely to the upslope side of the posts using heavy duty wire staples at least 1 inch long, tie wires or hog rings. The wire shall extend into the trench a minimum of 2 inches and shall not extend more than 36 inches above the original ground surface.
6. The standard strength filter fabric shall be stapled or wired to the fence, and 8 inches of the fabric shall be extended into the trench. The fabric shall not extend more than 36 inches above the original ground surface. Filter fabric shall not be stapled to existing trees.
7. When extra strength filter fabric and closer post spacing are used, the wire mesh support fence may be eliminated. In such a case, the filter fabric is stapled or wired directly to the posts with all other provisions of item no. 6 applying.
8. The trench shall be backfilled and the soil compacted over the filter fabric.

9. Silt fences shall be removed when they have served their useful purposes, but not before the upslope area has been permanently stabilized.

Maintenance

1. Silt fences and filter barriers shall be inspected immediately after each rainfall and at least daily during prolonged rainfall. Any required repairs shall be made immediately.
2. Should the fabric on a silt fence or filter barrier decompose or become ineffective prior to the end of the expected usable life and the barrier shall be necessary, the fabric shall be replaced promptly.
3. Sediment deposits should be removed after each storm event. They must be removed when deposits reach approximately one-half the height of the barrier.
4. Any sediment deposits remaining in place after silt fence or filter barrier is no longer required shall be dressed to conform with the existing grade, prepared and seeded.

1. Set posts and excavate a 4"x4" trench upslope along the line of posts.

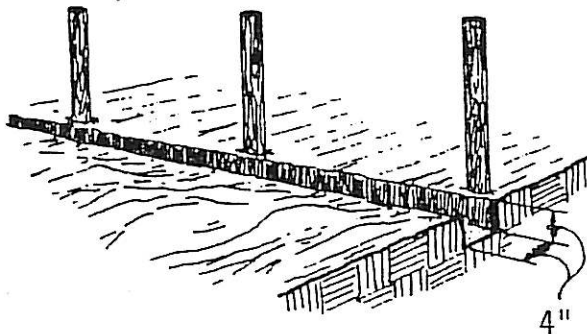

2. Staple wire fencing to the posts.

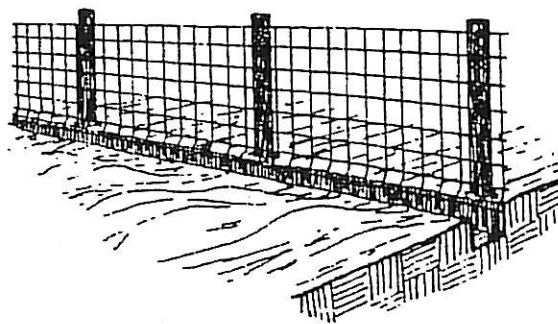

3. Attach the filter fabric to the wire fence and extend it into the trench.

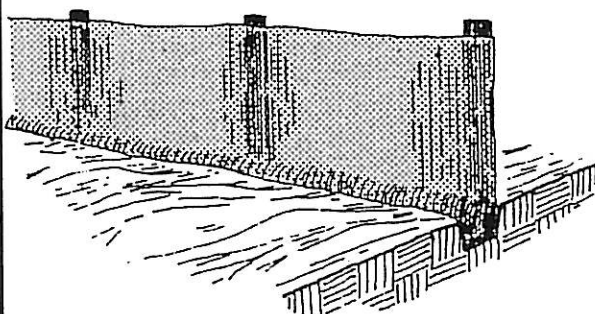

4. Backfill and compact the excavated soil.

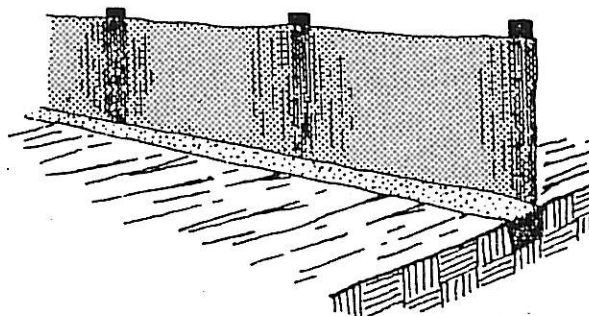

Extension of fabric and wire into the trench.

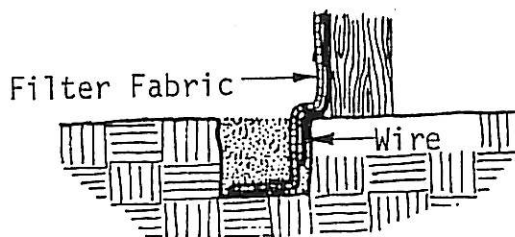

CONSTRUCTION OF A SILT FENCE

Exhibit 1100-7

(Source: Virginia Erosion and Sediment Control Handbook)

- NOTES:**
1. SET 6" T-POSTS AND EXCAVATE A 4"x4" TRENCH UPSTREAM ALONG LINE OF POSTS.
 2. ATTACH WIRE FENCE TO POSTS.
 3. ATTACH FILTER FABRIC TO WIRE FENCE AND EXTEND INTO TRENCH.
 4. BACKFILL AND COMPACT EXCAVATED SOIL.

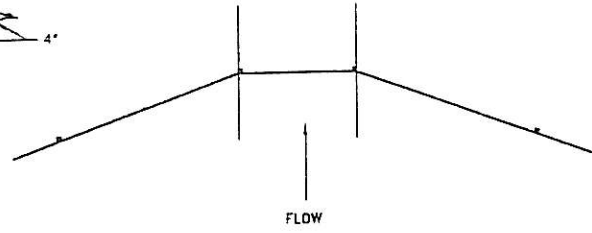
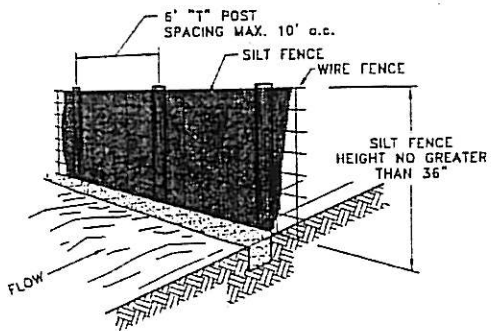
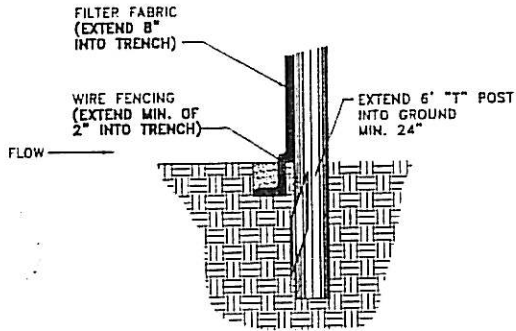
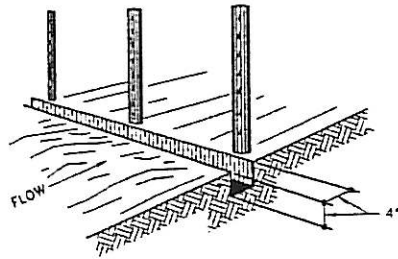

PLAN

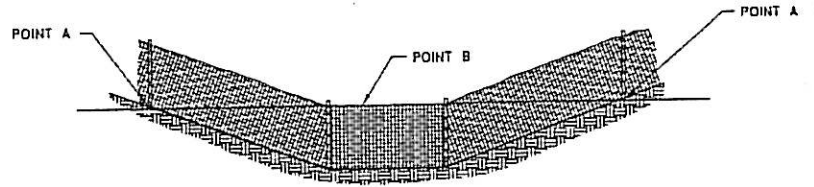

POINTS A SHOULD BE HIGHER THAN POINT B

ELEVATION

SILT FENCE BARRIER IN DRAINAGE WAY

NTS

Exhibit 1100-8

GEOTEXTILE FABRIC
(TYPE 4) IN ACCORDANCE
WITH SECTION 625

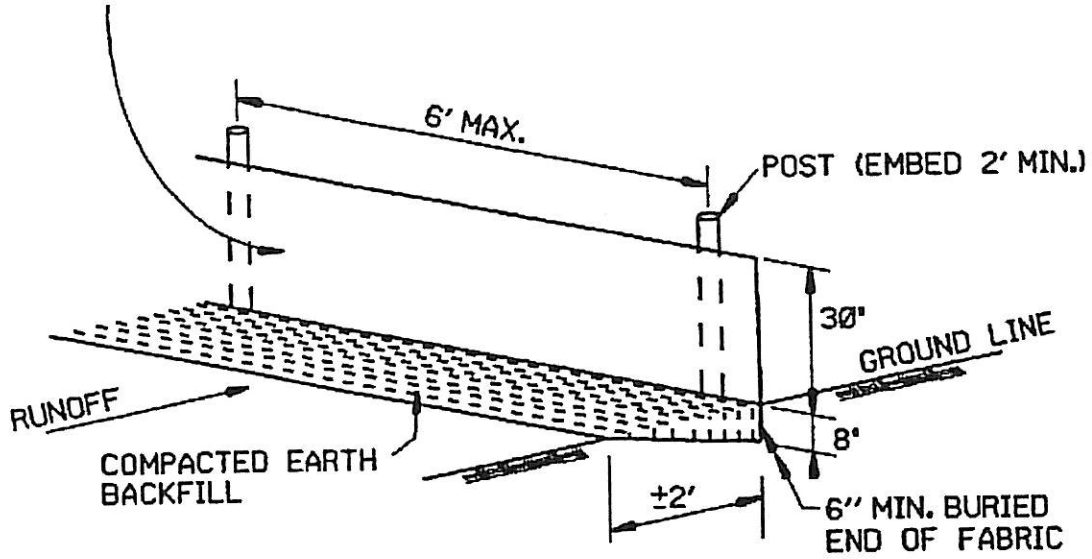

SILT FENCE (E-11)

GENERAL NOTES

GEOTEXTILE FABRIC SHALL BE SPLICED TOGETHER WITH A SEWN SEAM ONLY AT A SUPPORT POST, OR TWO SECTIONS OF FENCE MAY BE OVERLAPPED INSTEAD. PAYMENT OF ADDITIONAL MATERIAL FOR OVERLAP WILL NOT BE MADE.

Exhibit 1100-9

(Source: Arkansas Highway and Transportation Department Drainage Manual)

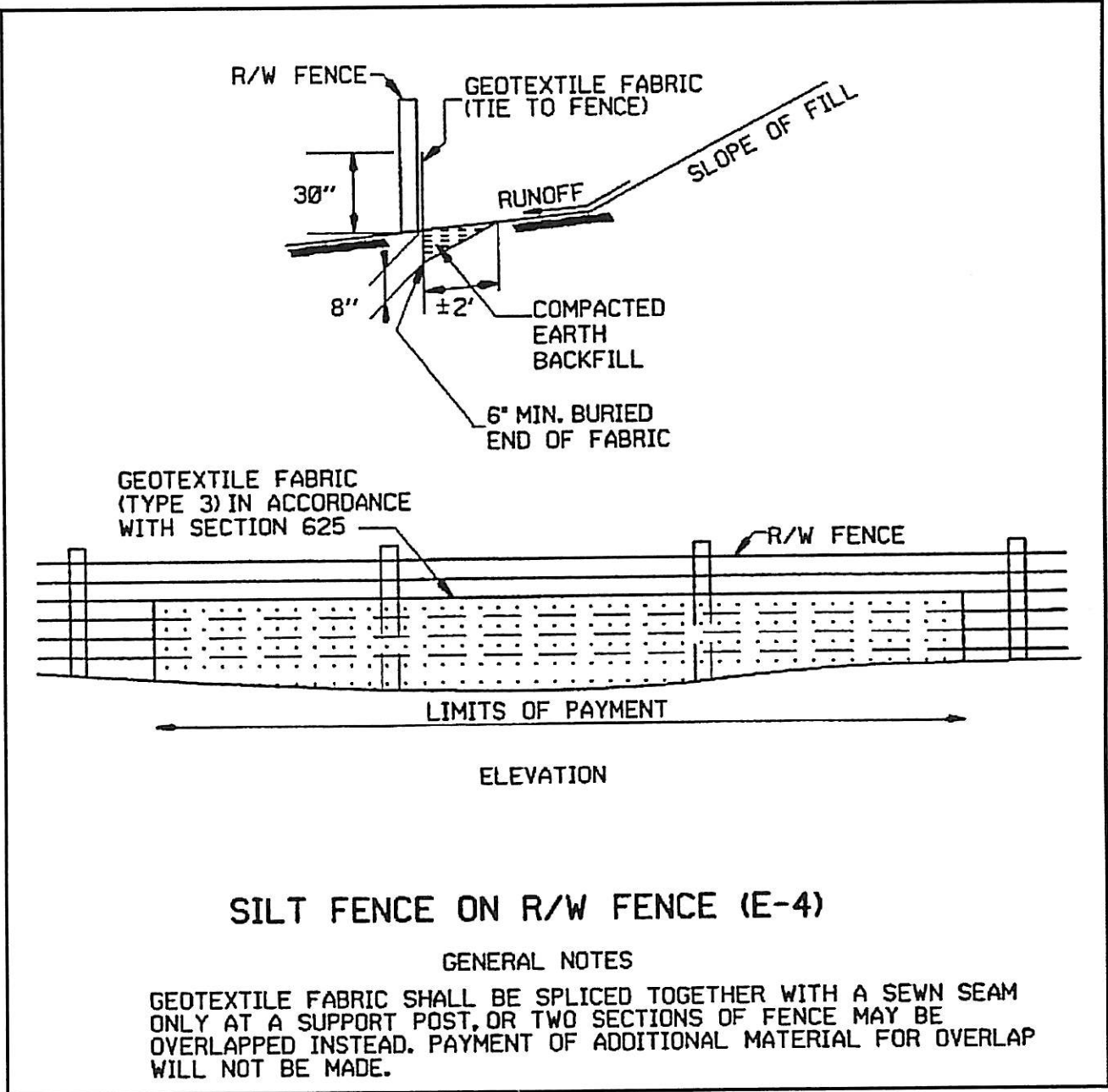

Exhibit 1100-10

(Source: Arkansas Highway and Transportation Department Drainage Manual)

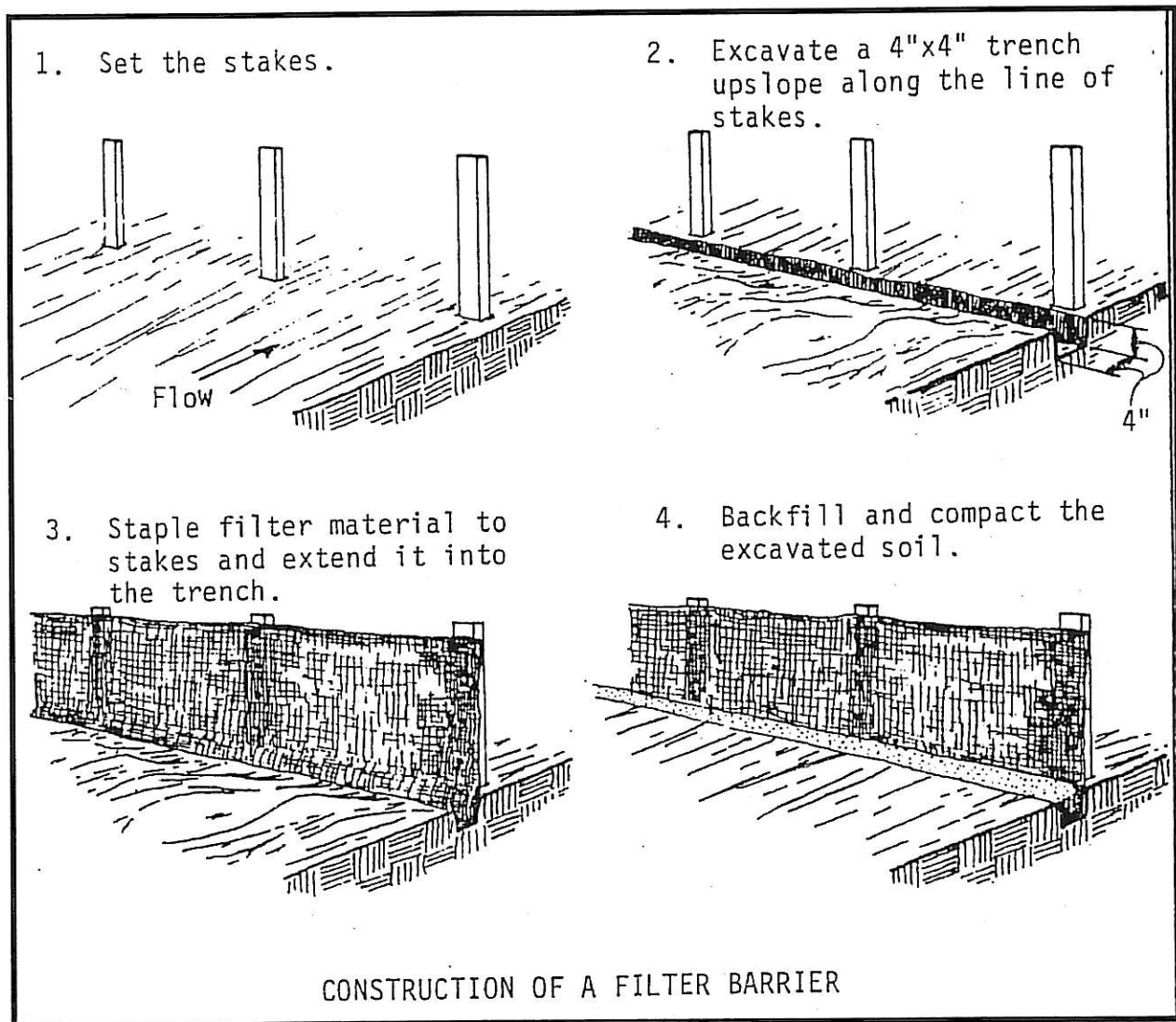
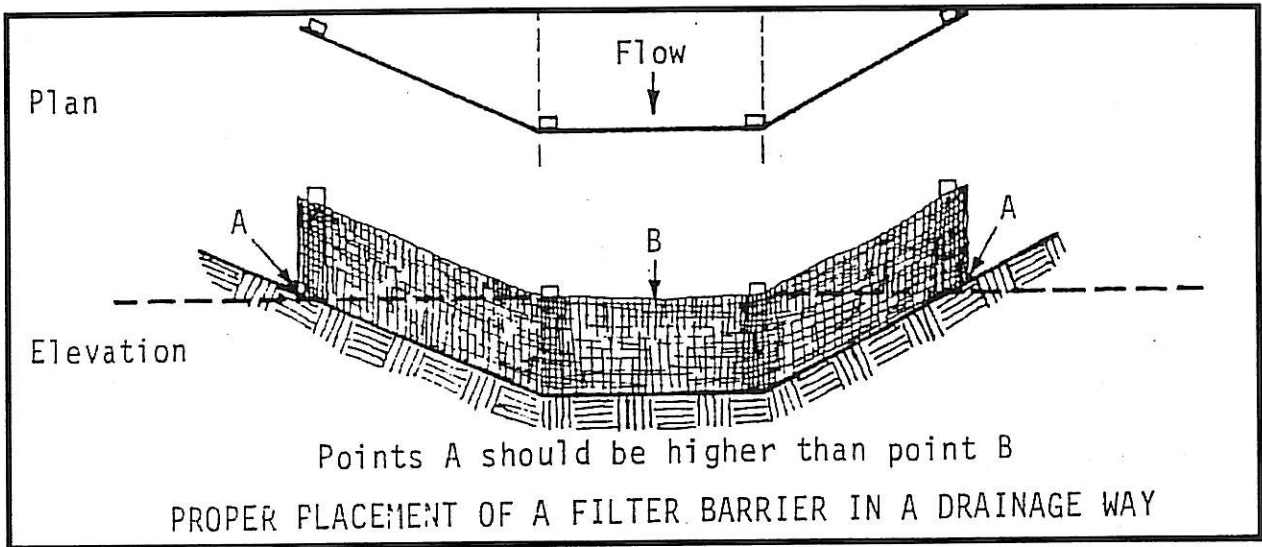

Exhibit 1100-11

(Source: Virginia Erosion and Sediment Control Handbook)

1105.3 Stabilized Construction Entrance (Exhibit 1100-12)

Definition

A stabilized pad of aggregate located at any point where traffic will be entering or leaving a construction site to or from a public right-of-way, street, alley, sidewalk, or parking area.

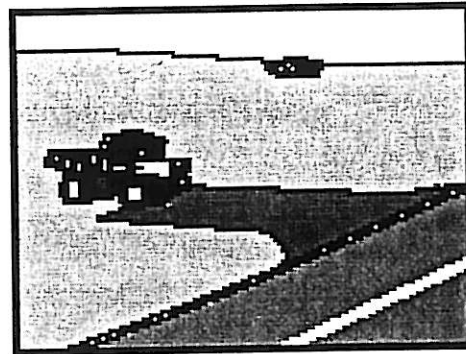

Objective

The objective of a stabilized construction entrance is to:

- Soil stabilization
- Sediment Control
- Tracking Control
- Wind Erosion Control

Purpose

The purpose of a stabilized construction entrance is to reduce or eliminate the tracking or flowing of sediment onto public rights-of-way or streets.

Application

A stabilized construction entrance applies to all points of construction ingress and egress. A stabilized construction entrance applies wherever traffic will be leaving a construction site and move directly onto a public road or other paved area.

Stabilized construction entrance/exit should be used at construction sites:

- A. where dirt or mud is tracked onto public roads
- B. adjacent to water bodies
- C. where poor soils are encountered
- D. where dust is a problem during dry weather conditions

Planning Considerations

Roads adjacent to a construction site shall be clean at the end of each day. Construction entrances provide an area where mud can be removed from construction vehicle tires before they enter a public road. If the action of the vehicle traveling over the gravel pad is not sufficient to remove the majority of the mud, then the tires must be washed before the vehicle enters a public road. When washing is required, it shall be done on an area stabilized with crushed stone which drains into an approved sediment trapping device before entering any storm drain, ditch, or watercourse prior to being carried off-site

Design Criteria

A design is not required for a stabilized construction entrance, however, the following criteria in Table 1100-3 shall be used.

TABLE 1100-3 Stabilized Construction Entrance Design Criteria

Aggregate:	Use 2 inch stone, or reclaimed or recycled concrete equivalent
Thickness:	Not less than six (6) inches
Width:	Not less than full width of all points of ingress and egress Twenty (20) foot minimum
Length:	As required, but not less than 50 feet
Location:	Located to provide for maximum utility by all construction vehicles.
Washing:	If conditions on the site are such that the majority of the mud is not removed by the vehicles traveling over the grave, then the tires of the vehicles must be washed before entering a public road. Wash water must be carried away from the entrance to a settling area to remove sediment. A wash rack may also be used to make washing more convenient and effective.

Construction Specifications

The area of the entrance should be cleared of all vegetation, roots, and other objectionable material. The gravel shall be placed to the specified dimensions. Any drainage facilities required because of washing should be constructed according to specifications. If wash racks are used, they should be installed according to manufacturer's specifications.

Maintenance

The entrance shall be maintained in a condition which will prevent tracking or flowing of sediment onto public rights-of-way or streets. This may require periodic top dressing with additional aggregate as conditions demand. All sediment spilled, dropped, washed, or tracked onto public rights-of-way must be removed immediately.

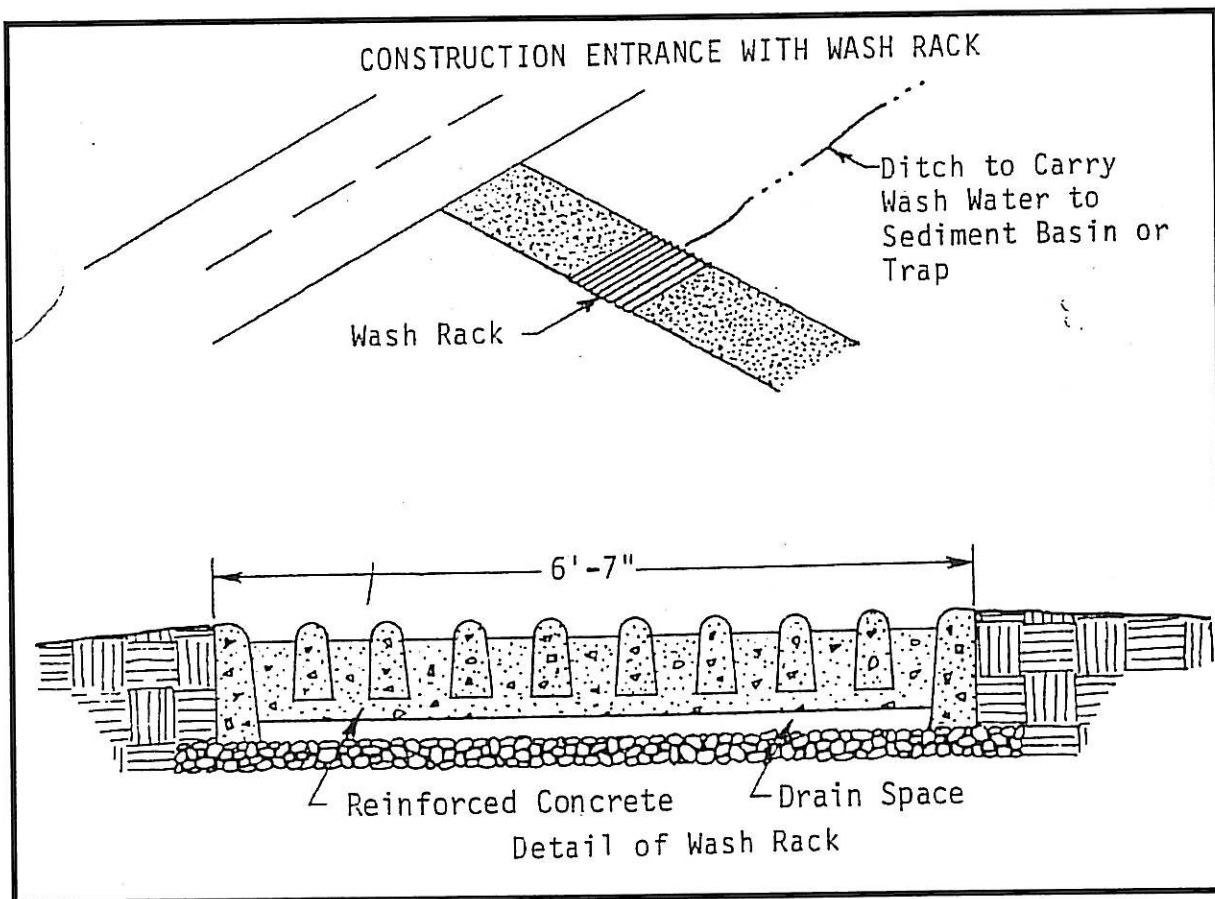
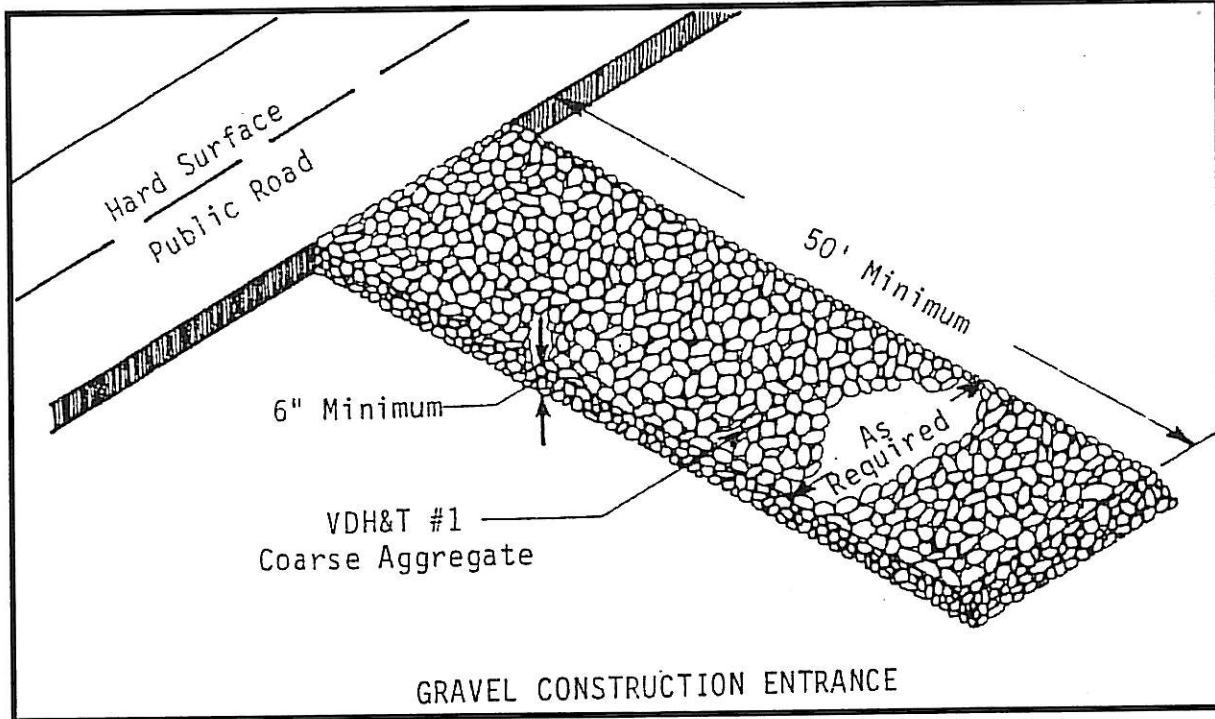

Exhibit 1100-12

(Source: Virginia Erosion and Sediment Control Handbook)

1105.4 Storm Drain Inlet Protection (Exhibit 1100-13 thru 1100-19)

Definition

A sediment filter or an excavated impounding area around a storm drain drop inlet.

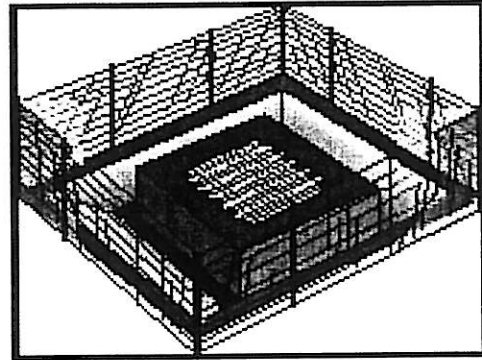

Objective

The objective of storm drain inlet protection is to:

- Soil stabilization
- Sediment Control
- Tracking Control
- Wind Erosion Control

Purpose

The purpose for storm drain inlet protection is to prevent sediment from entering storm drainage systems prior to permanent stabilization of the disturbed area.

Application

Protection for storm drain inlets is applicable when storm drain inlets are to be made operational before permanent stabilization of the disturbed drainage area is completed.

Storm Drain Inlet Protection should be used at construction sites:

- A. Where ponding will not encroach into highway traffic.
- B. Where sediment laden surface runoff may enter an inlet.
- C. Where disturbed drainage areas have not yet been permanently stabilized.
- D. Where the drainage area is 0.4 ha (1 ac) or less.
- E. Appropriate during wet and snow-melt seasons.

Planning Considerations

Storm sewers can convey large amounts of sediment to natural drainage ways when they are made operational prior to drainage area stabilization. A storm sewer may clog under extreme sediment loading, which results in lost capacity of the storm sewer. To avoid these problems, it is necessary to prevent sediment from entering the system at the inlets.

There are several inlet filters and traps described in this section, which have different applications dependent upon site conditions and type of inlet. Innovative techniques for accomplishing the same purpose are encouraged, but only after submittal and approval by the City Engineer.

The inlet protection devices described in this section are for drainage areas of less than one acre. Runoff from large disturbed areas should be routed through a temporary sediment trap.

The most effective way to prevent sediment from entering the storm drainage system is to stabilize the contributing area as soon as possible, therefore preventing erosion and stopping sediment at its source.

Design Criteria

The drainage area shall be no greater than 1 acre. The inlet protection device shall be constructed in a manner that will facilitate cleanout of trapped sediment while minimizing interference with construction activities. The inlet protection device will not cause resultant ponding of stormwater, which causes excessive inconvenience or damage to adjacent areas or structures.

Construction Specifications

Straw Bale Drop Inlet Structure (Exhibit 1100-13 and 1100-14)

1. Bales shall be either wire-bound or string-tied with the bindings oriented around the sides rather than over and under the bales.
2. Bales shall be placed lengthwise in a single row surrounding the inlet, with the ends of adjacent bales pressed together.
3. The filter barrier shall be entrenched and backfilled. A trench shall be excavated around the inlet the width of a bale to a minimum depth of 4 inches. After the bales are staked, the excavated soil shall be backfilled and compacted against the filter barrier.
4. Each bale shall be securely anchored and held in place by at least two stakes or re-bars driven through the bale.
5. Loose straw shall be wedged between bales to prevent water from entering between bales.
6. This can be used effectively during construction on drainage without tops

Burlap/Geotextile Drop Inlet Sediment Filter (Exhibit 1100-15 and 1100-16)

1. Burlap shall be 10 ounce per square yard fabric and shall be cut from a continuous roll to avoid joints. Geotextile fabric (Type 3) is allowable substitute.
2. Stakes shall be 1" x 2" wood or equivalent metal with a minimum length of 3 feet.
3. Staples shall be of heavy duty wire at least ½ inch long.
4. Stakes shall be spaced around the perimeter of the inlet a maximum of 3 feet apart and securely driven into the ground a minimum of 8 inches.
5. A trench shall be excavated approximately 4 inches wide and 4 inches deep around the outside perimeter of the stakes.
6. The burlap shall be stapled to the wooden stakes, and 8 inches of the fabric shall be extended into the trench. The height of the filter barrier shall be a minimum of 15 inches and shall not exceed 18 inches.

7. The trench shall be backfilled and the soil compacted over the burlap.

Gravel and Wire Mesh Drop Inlet Sediment Filter (Exhibit 1100-17)

1. Wire mesh shall be laid over the drop inlet so that the wire extends a minimum of 1 foot beyond each side of the inlet structure. Hardware cloth or comparable wire mesh with ½ inch openings shall be used. If more than one strip of mesh is necessary, the strips shall be overlapped.
2. Coarse aggregate shall be placed over the wire mesh per detail. The depth of stone shall be at least 12 inches over the entire inlet opening. The stone shall extend beyond the inlet opening at least 18 inches on all sides.
3. If the stone filter becomes clogged with sediment so that it no longer adequately performs its function, the stones must be pulled away from the inlet, cleaned and replaced.
4. This filtering device has no overflow mechanism, therefore, ponding is likely especially if sediment is not removed regularly. This type of device must never be used where overflow may endanger an exposed fill slope. Consideration should also be given to the possible effects of ponding on traffic movement, nearby structures, working areas, adjacent property, etc.

Block and Gravel Drop Inlet Sediment Filter (Exhibit 1100-18)

1. Place concrete blocks lengthwise on their sides in a single row around the perimeter of the inlet, with the ends of adjacent blocks abutting. The height of the barrier can be varied, depending on design needs, by stacking combinations of 4-inch, 8-inch and 12-inch wide blocks. The barrier of blocks shall be at least 12 inches high and no greater than 24 inches high.
2. Wire mesh shall be placed over the outside vertical face of the concrete blocks to prevent stone from being washed through the holes in the blocks. Hardware cloth or comparable wire mesh with ½ inch openings shall be used.
3. Stone shall be piled against the wire to the top of the block barrier with coarse aggregate.
4. If the stone filter becomes clogged with sediment so that it no longer adequately performs its function, the stone must be pulled away from the blocks, cleaned and replaced.

Block and Gravel Curb Inlet Sediment Filter (Exhibit 1100-19)

1. Two concrete blocks shall be placed on their sides abutting the curb at either side of the inlet opening.
2. A 2-inch by 4-inch stud shall be cut and placed through the outer holes of each spacer block to help the front blocks in place.
3. Concrete blocks shall be placed on their sides across the front of the inlet and abutting the spacer block.
4. Wire mesh shall be placed over the outside vertical face of the concrete blocks to prevent stone from being washed through the holes in the blocks. Chicken wire or hardware cloth with ½ inch openings shall be used.
5. Coarse aggregate shall be piled against the wire to the top of the barrier.

6. If the stone filter becomes clogged with sediment so that it no longer adequately performs its function, the stone must be pulled away from the block, cleaned and replaced.

Excavated Drop Inlet Sediment Trap (Exhibit 1100-20)

1. The excavated trap shall be sized to provide a minimum storage capacity calculated at the rate of 67 cubic yards for 1 acre of drainage area. A trap shall be no less than 1 foot nor more than 2 feet deep measured from the top of the inlet structure. Side slopes shall not be steeper than 2:1.
2. The slope of the basin may vary to fit the drainage area and terrain. Observations must be made to check trap efficiency and modifications shall be made as necessary to insure satisfactory trapping of sediment. Where an inlet is located so as to receive concentrated flows, such as in a highway median, it is recommended that the basin have a rectangular shape in a 2:1 ratio, with the length oriented in the direction of the flow.
3. Sediment shall be removed and the trap restored to its original dimensions when the sediment has accumulated to $\frac{1}{2}$ the design depth of the trap. Removed sediment shall be deposited in a suitable area and in a manner such that it will not erode.

Sod Drop Inlet Sediment Filter (Exhibit 1100-21)

1. Soil shall be prepared and sod installed.
2. Sod shall be placed to form a turf mat covering the soil for a distance of 4 feet from each side of the inlet structure.

Gravel Curb Inlet Sediment Filter (Exhibit 1100-22)

1. Hardware cloth or comparable wire mesh with $\frac{1}{2}$ inch openings shall be placed over the curb inlet opening so that at least 12 inches of wire extends across the inlet cover and at least 12 inches of wire extends across the concrete gutter from the inlet opening.
2. Coarse aggregate Stone shall be piled against the wire so as to anchor it against the gutter and inlet cover and to cover the inlet opening completely.
3. If the stone filter becomes clogged with sediment so that it no longer adequately performs its function, the stone must be pulled away from the block, cleaned and replaced.

Maintenance

1. The structure shall be inspected after each rain and repairs made as needed.
2. Sediment shall be removed and the trap restored to its original dimensions when the sediment has accumulated to $\frac{1}{2}$ the design depth of the trap. Removed sediment shall be deposited in a suitable area and in such a manner that it will not erode.
3. Structures shall be removed and the area stabilized when the remaining drainage area has been properly stabilized.

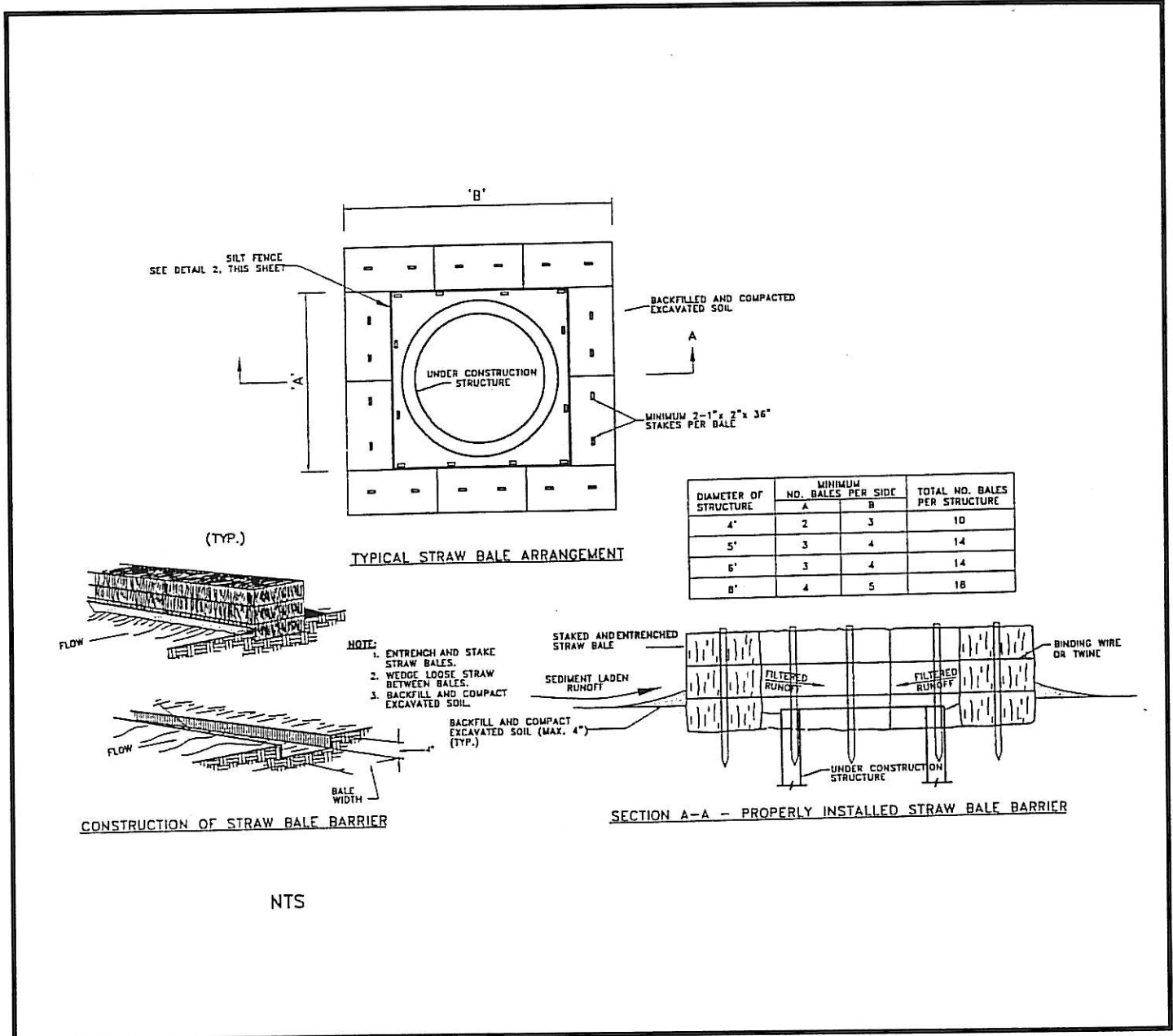

Exhibit 1100-13

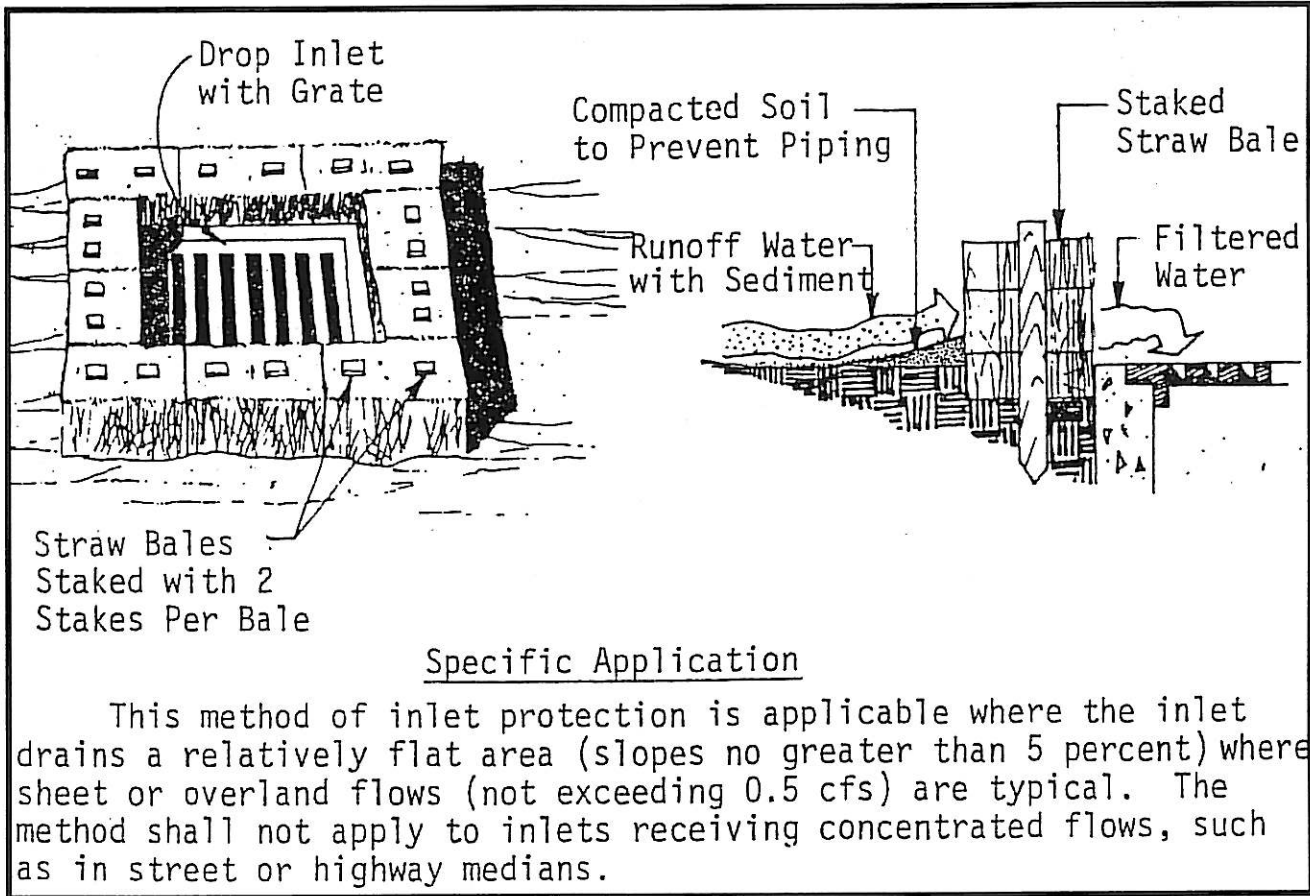
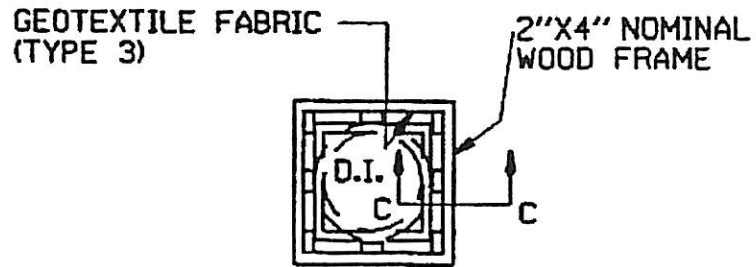
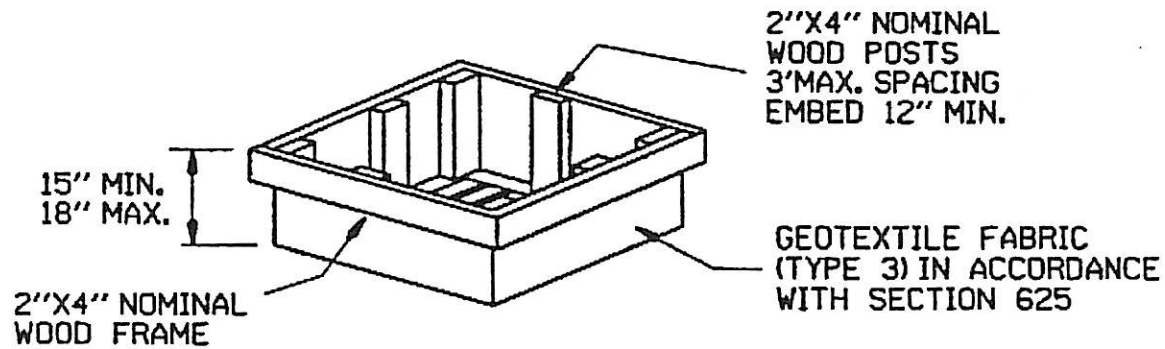
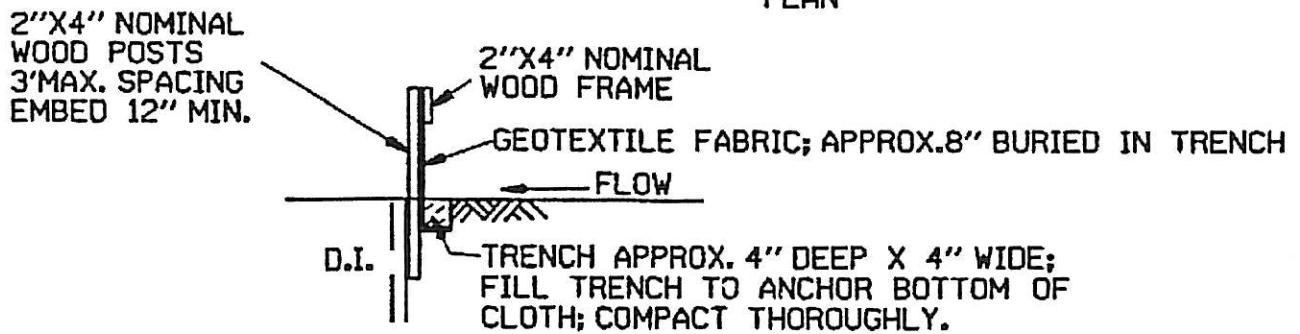

Exhibit 1100-14

(Source: Virginia Erosion and Sediment Control Handbook)



PLAN



SECTION C-C

DROP INLET SILT FENCE (E-7)

Exhibit 1100-15

(Source: Arkansas Highway and Transportation Department Drainage Manual)

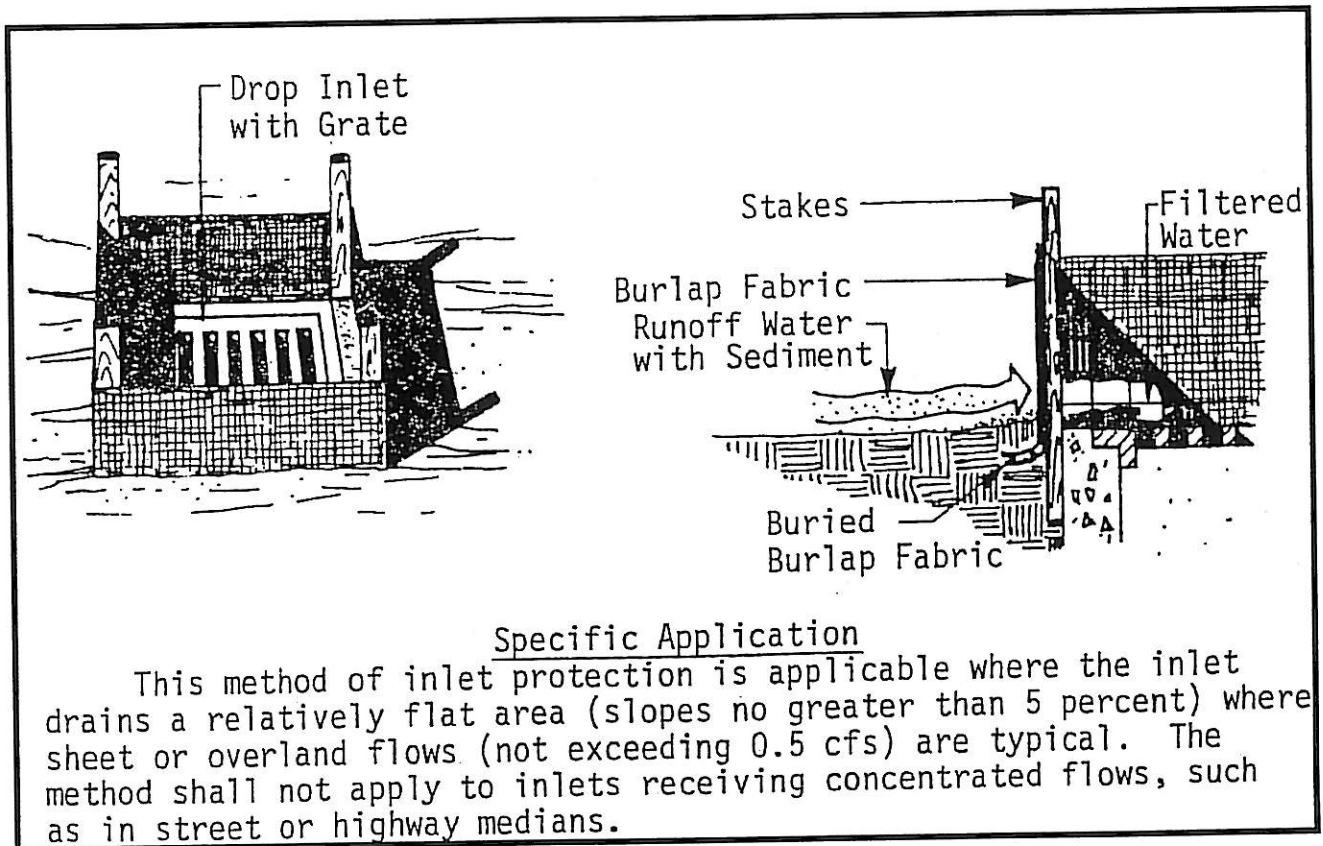

Exhibit 1100-16

(Source: Virginia Erosion and Sediment Control Handbook)

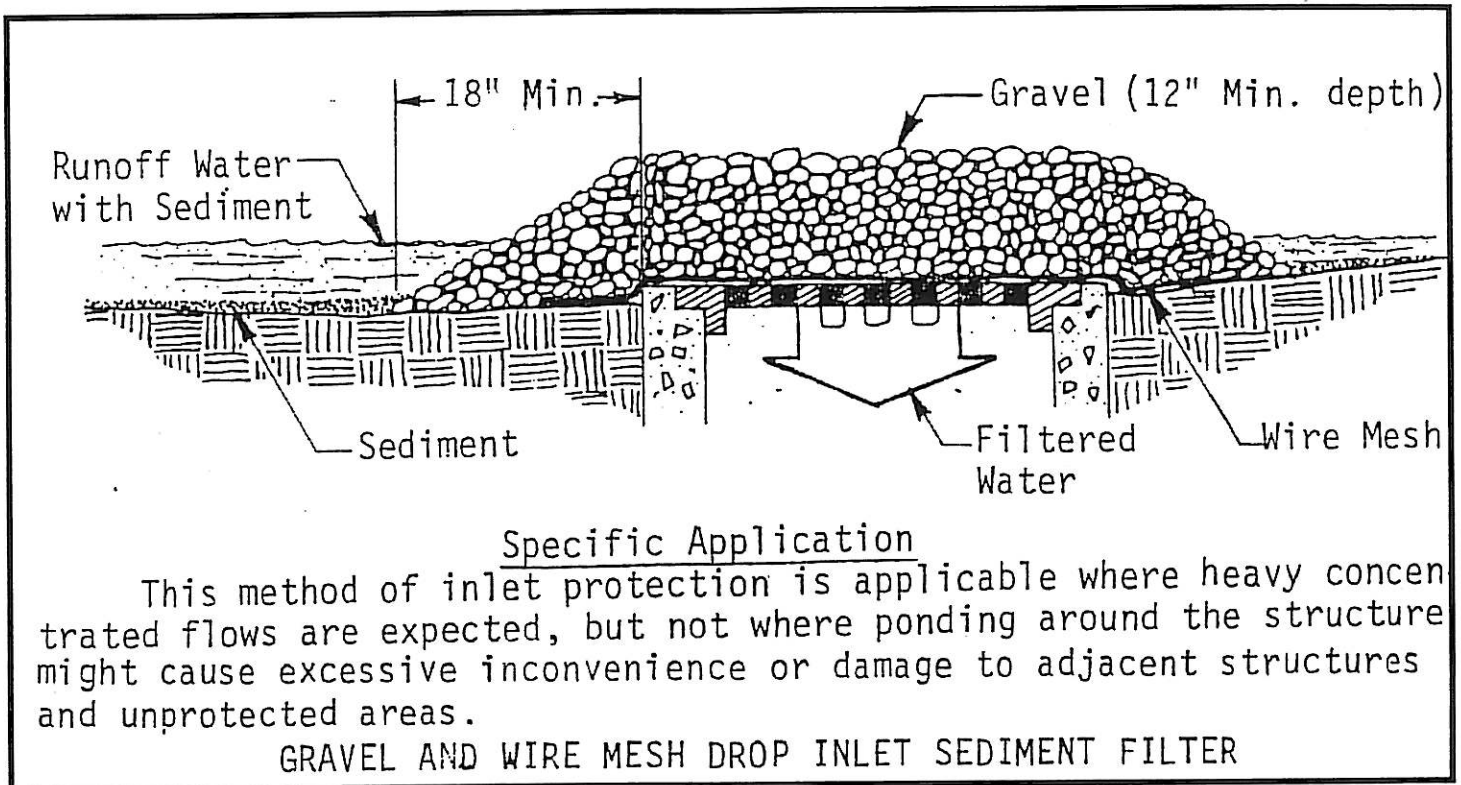
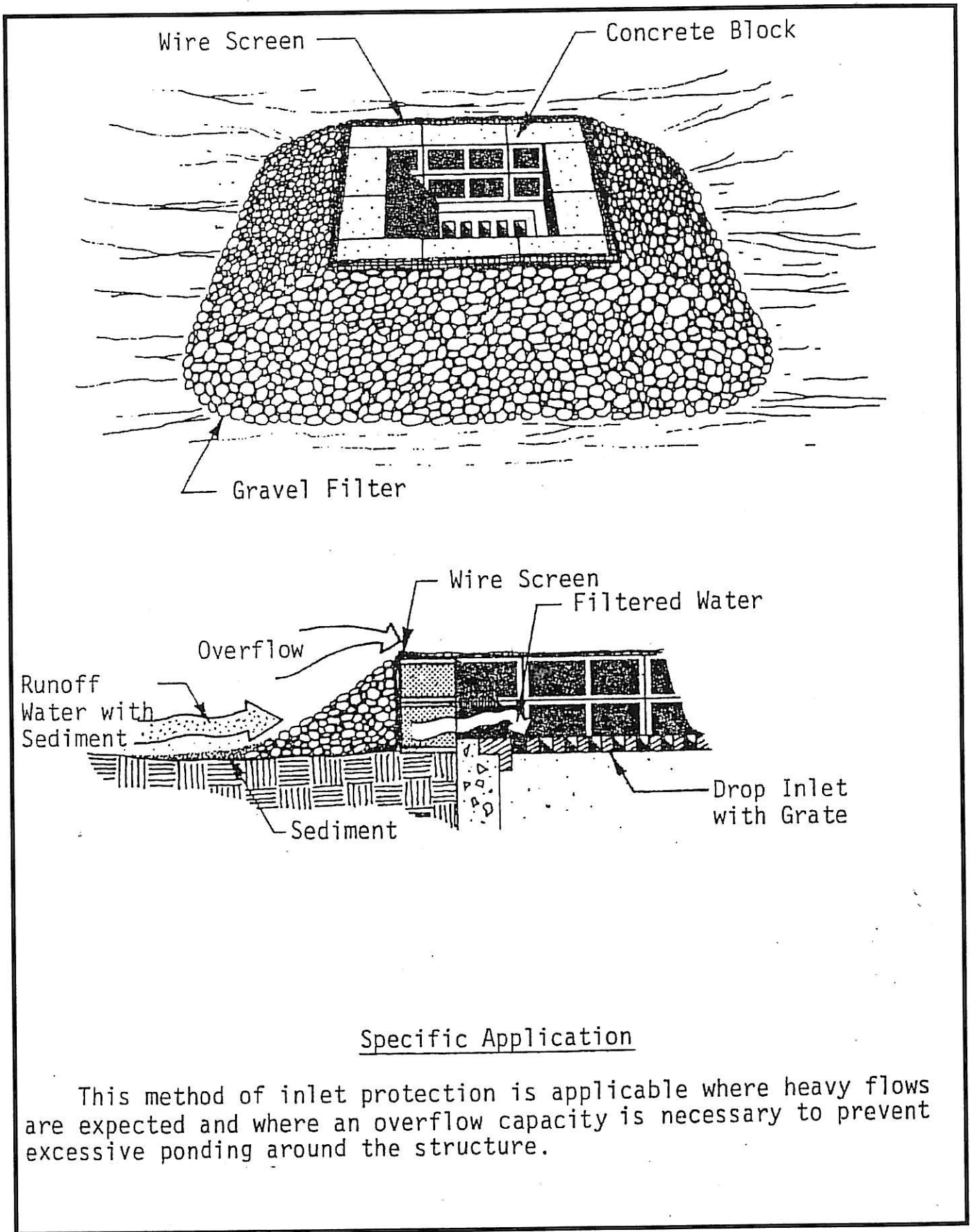

Exhibit 1100-17

(Source: Virginia Erosion and Sediment Control Handbook)



Specific Application

This method of inlet protection is applicable where heavy flows are expected and where an overflow capacity is necessary to prevent excessive ponding around the structure.

Exhibit 1100-18 (Source: Virginia Erosion and Sediment Control Handbook)

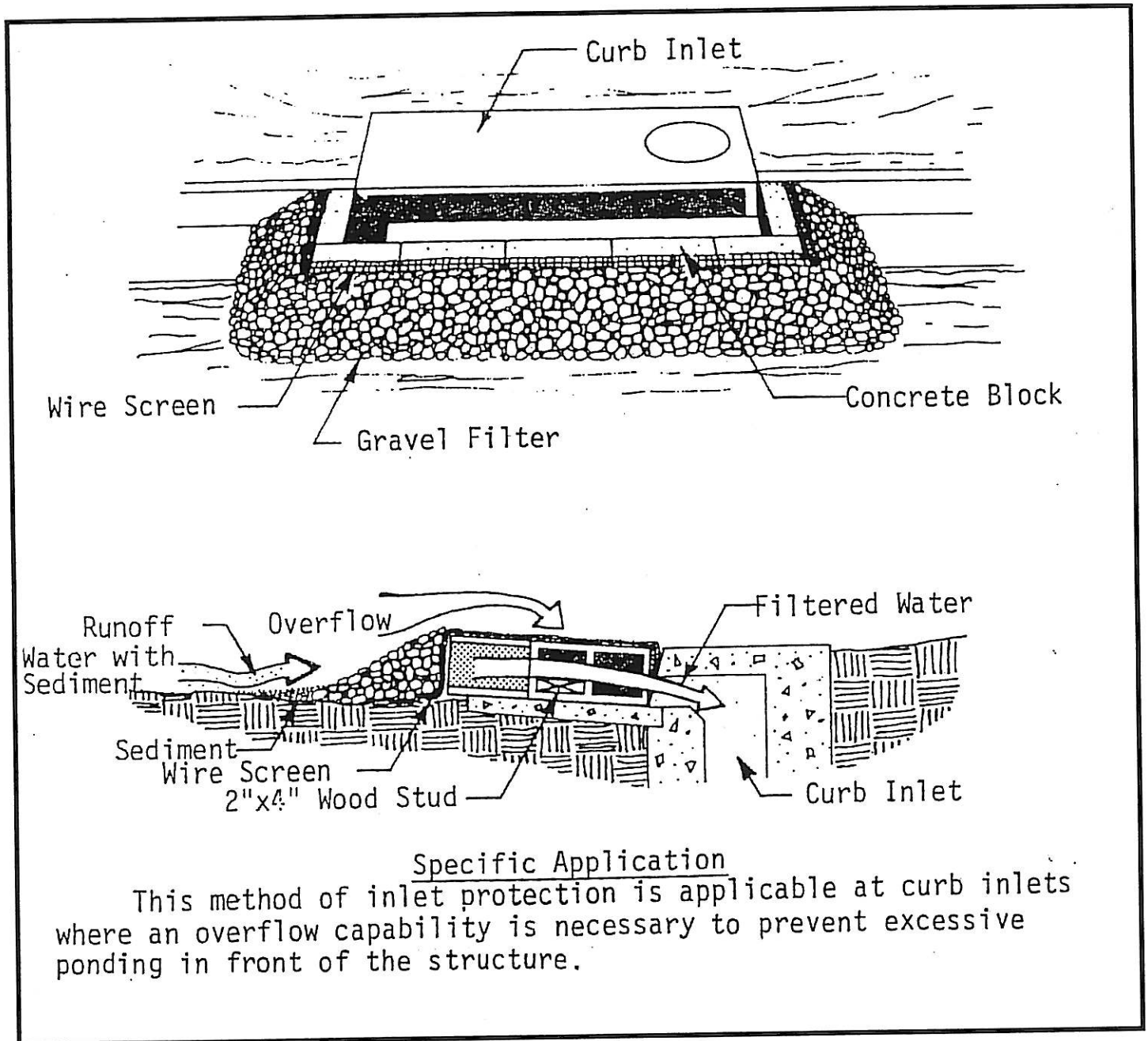

Specific Application

This method of inlet protection is applicable at curb inlets where an overflow capability is necessary to prevent excessive ponding in front of the structure.

Exhibit 1100-19

(Source: Virginia Erosion and Sediment Control Handbook)

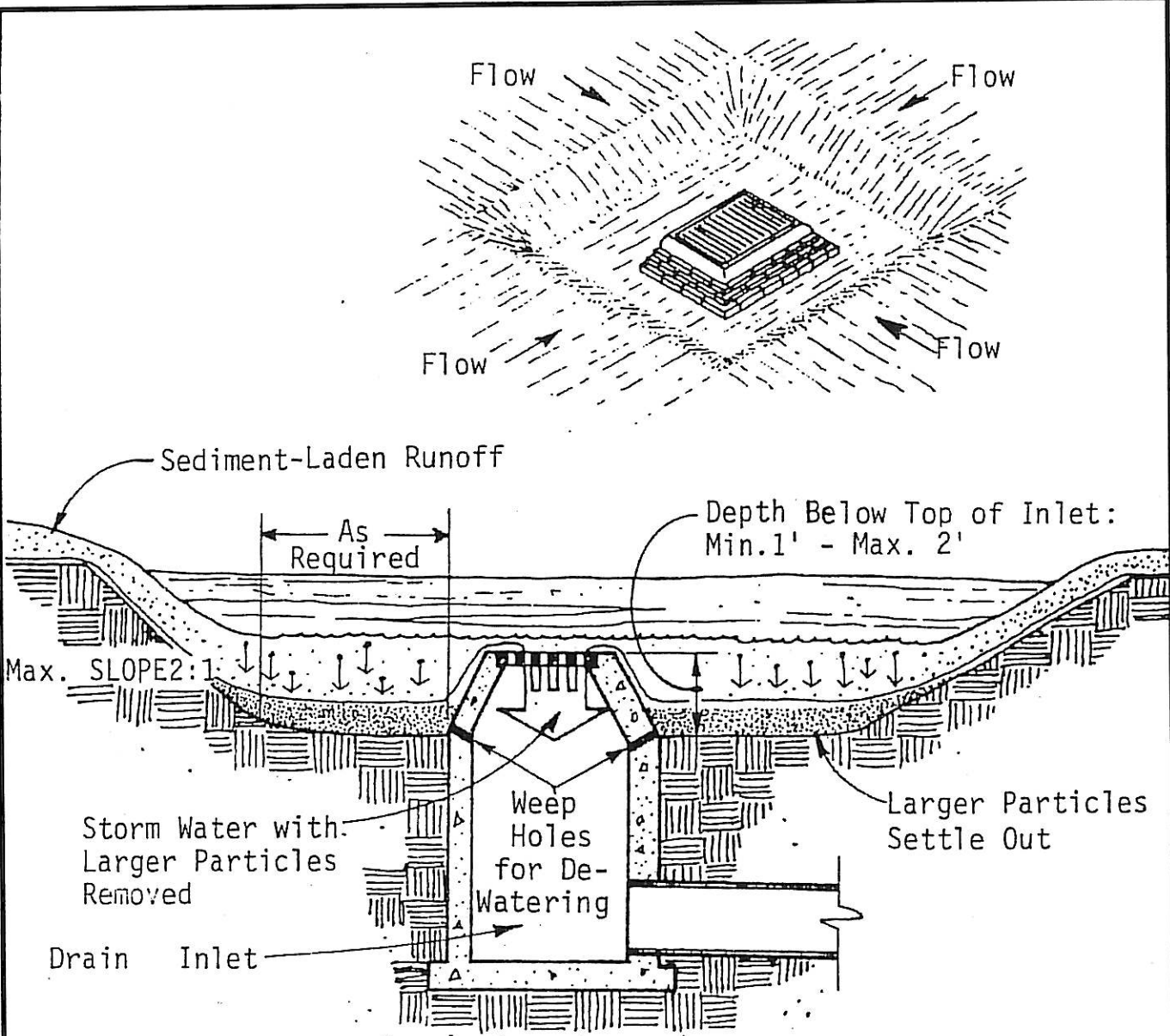

Specific Application

This method of inlet protection is applicable where heavy flows are expected and where an overflow capability and ease of maintenance are desirable.

Exhibit 1100-20

(Source: Virginia Erosion and Sediment Control Handbook)

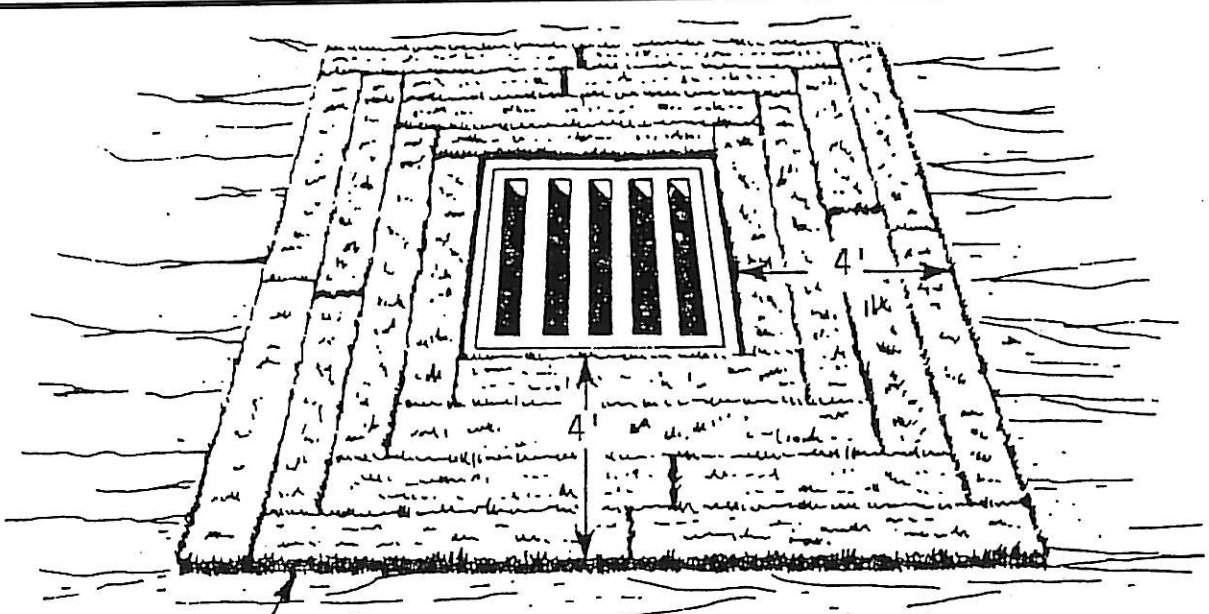

Four 1-foot Wide Strips of Sod on Each Side of the Drop Inlet

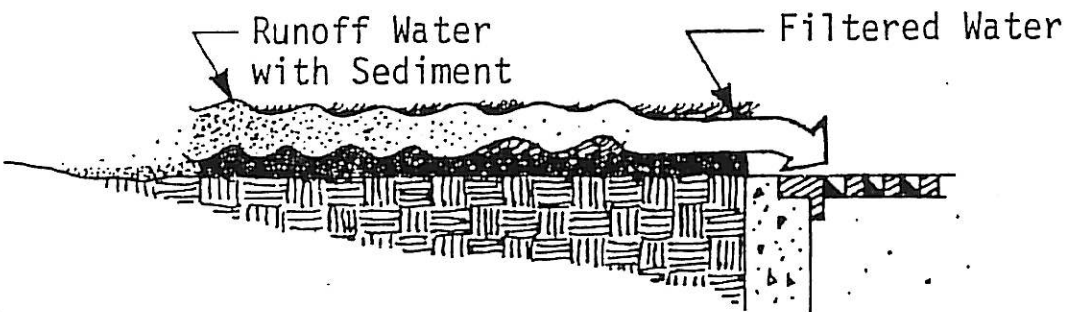

Specific Application

This method of inlet protection is applicable only at the time of permanent seeding, to protect the inlet from sediment and mulch materials until permanent vegetation has become established.

Exhibit 1100-21

(Source: Virginia Erosion and Sediment Control Handbook)

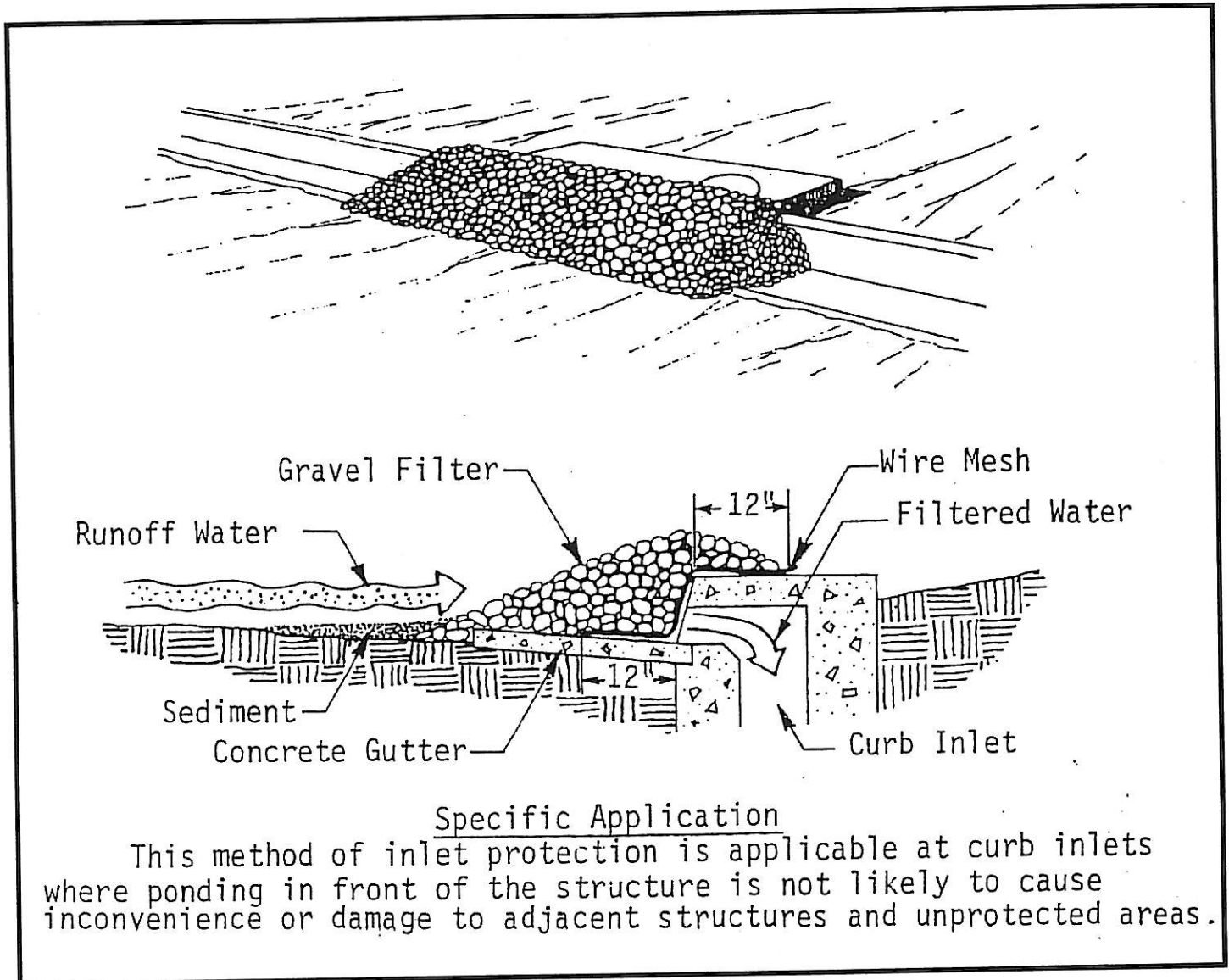

Specific Application

This method of inlet protection is applicable at curb inlets where ponding in front of the structure is not likely to cause inconvenience or damage to adjacent structures and unprotected areas.

Exhibit 1100-22

(Source: Virginia Erosion and Sediment Control Handbook)

1105.5 Temporary Diversion Ditch (Exhibits 1100-23 and 1100-25)

Definition

A drainage way of parabolic or trapezoidal cross section that is constructed with a supporting ridge on the lower side cut along the top of an active earth embankment.

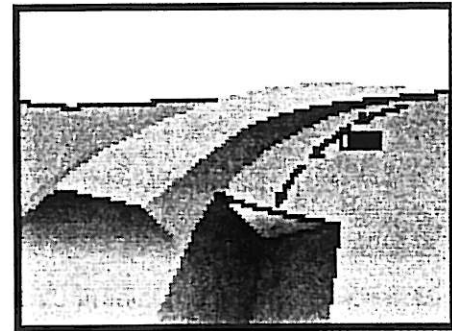

Objective

The objective of a temporary diversion ditch is to:

- Soil stabilization
- Sediment Control
- Tracking Control
- Wind Erosion Control

Purpose

The purpose of a diversion ditch is to intercept and convey runoff away from an unprotected slope of an embankment to stable outlets at non-erosive velocities. Temporary diversion ditches are installed as an interior measure to facilitate some phase of construction and usually have a life expectancy of 1 year or less. A permanent diversion ditch is an integral part of an overall water disposal system and remains for protection of property.

Application

Temporary diversion ditches are used to:

- A. be included as a part of a pollution abatement system.
- B. address situations when the drainage area at the top of an active earth fill slopes toward the exposed slope.
- C. Convey surface runoff down sloping land
- D. Intercept and divert runoff to avoid sheet flow over sloped surfaces
- E. Divert and direct runoff towards a stabilized watercourse, drainage pipe or channel.
- F. To intercept runoff from paved surfaces.
- G. Below steep grades where runoff begins to concentrate
- H. Along roadways and facility improvements subject to flood drainage.

- I. At the top of slopes to divert run-on from adjacent or undisturbed slopes.
- J. At bottom and mid-slope locations to intercept sheet flow and convey concentrated flows.

Planning Considerations

It is important to keep stormwater runoff away from exposed slopes. This is often accomplished by installing a diversion or paved ditch at the top of a slope in order to carry runoff away from the slope to a stabilized outlet. These measures are installed after the final grade has been reached. On cuts, the diversion ditch may be installed at the beginning since the work proceeds from the top and the measures have little chance of being covered or damaged. On fills, the work proceeds from the bottom to the top and the elevation changes daily. It is therefore not feasible to construct a diversion ditch, which may be covered by the next day's activity.

The temporary diversion ditch is intended to provide some slope protection on a daily basis until final elevations are reached and a more permanent measure can be constructed. Wherever possible, the temporary diversion ditch should be sloped to direct water to a stabilized outlet. If the runoff is diverted over the fill itself, the practice may cause more problems than it solves by concentrating water at a single point.

Each diversion must have an adequate outlet. The outlet may be a grassed waterway, vegetated or paved area, grade stabilization structure, stable watercourse, or tile outlet. In all cases the outlet must convey runoff to a point where outflow will not cause damage. Vegetative outlets shall be installed prior to, and have vegetation established before diversion construction.

Good timing is essential to fill construction. The filling operation should be completed as quickly as possible and the permanent slope protection measures and slope stabilization measures installed as soon after completion as possible.

Design Criteria

1. No formal design is required.
2. The maximum allowable drainage area is 5 acres.
3. The minimum height of the supporting ridge shall be 9 inches.
4. The channel shall have a positive grade to a stabilized outlet
5. The diverted runoff should be released through a stabilized outlet, slope drain or sediment trapping measure.

Construction Specifications

1. The diversion ditch shall be constructed at the top of the fill at the end of each workday as needed.
2. The diversion ditch shall be located at least 2 feet inside the top edge of the fill.
3. The supporting ridge of the lower side shall be constructed with a uniform

height along its entire length.

Maintenance

Since the practice is temporary and under most situations will be covered the next working day, the maintenance required should be low. If the practice is to remain in use for more than one day, an inspection will be made at the end of each working day and repaired as needed. Placement of any material over the structure while it is in use should be avoided. Construction traffic should be prohibited from crossing the diversion ditch.

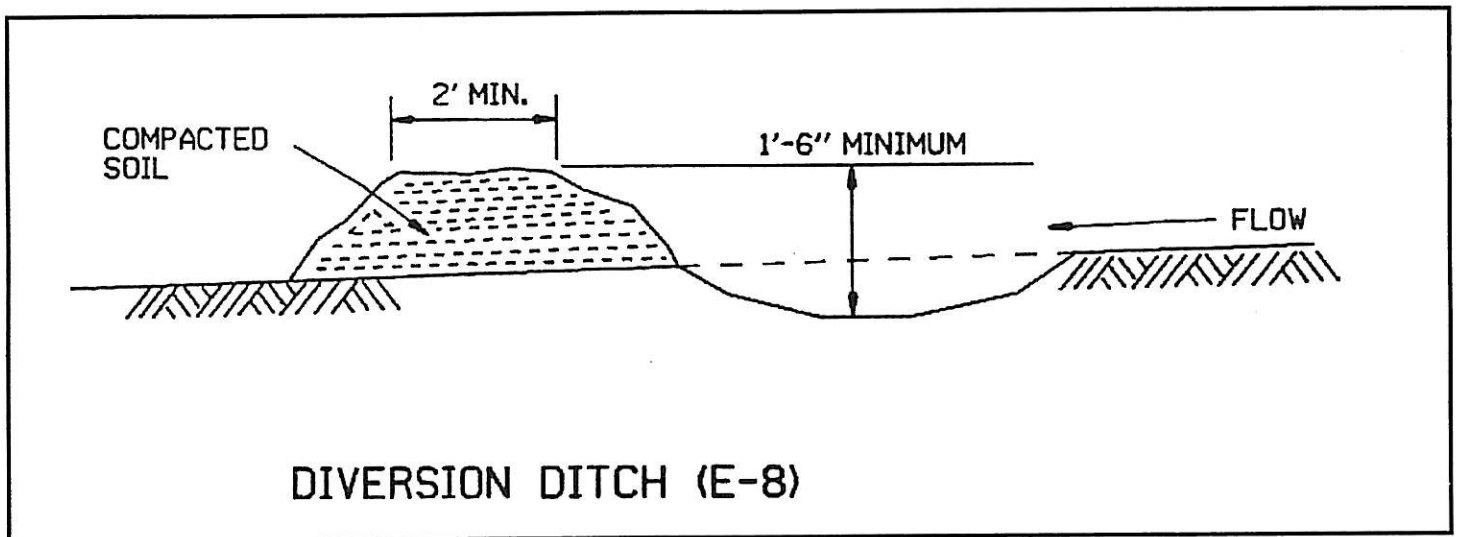

Exhibit 1100-23

(Source: Arkansas Highway and Transportation Department Drainage Manual)

GENERAL NOTES

DEFINITION – A CHANNEL WITH A SUPPORTING RIDGE ON THE LOWER SIDE CUT ALONG THE TOP OF A EARTH FILL.

PURPOSE – TO DIVERT STORM RUNOFF AWAY FROM THE UNPROTECTED SLOPE OF THE FILL TO A STABILIZED OUTLET OR SEDIMENT TRAPPING FACILITY.

CONDITIONS WHERE PRACTICE APPLIES – WHERE THE DRAINAGE AREA AT THE TOP OF AN ACTIVE EARTH FILL SLOPES TOWARD THE EXPOSED SLOPE AND WHERE CONTINUOUS FILL OPERATIONS MAKE THE USE OF A DIVERSION (STD. & SPEC. 1.18) UNFEASIBLE. THIS TEMPORARY STRUCTURE SHOULD REMAIN IN PLACE FOR LESS THAN ONE WEEK.

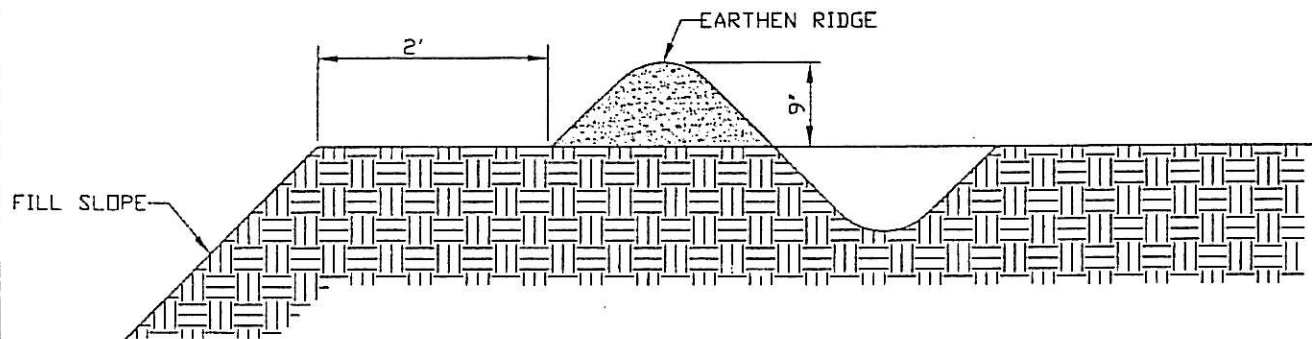

Exhibit 1100-24

(Source: Virginia Erosion and Sediment Control Handbook)

GENERAL NOTES

DEFINITION - A CHANNEL CONSTRUCTED ACROSS A SLOPE WITH A SUPPORTING RIDGE ON THE LOWER SIDE.

PURPOSE - TO REDUCE SLOPE LENGTH AND TO INTERCEPT AND DIVERT STORMWATER RUNOFF TO STABILIZED OUTLET AT NON-EROSIVE VELOCITIES.

CONDITIONS WHERE PRACTICE APPLIES -

1. WHERE RUNOFF FROM HIGHER AREAS MAY DAMAGE PROPERTY, CAUSE EROSION, OR INTERFERE WITH THE ESTABLISHMENT OF VEGETATION ON LOWER AREAS.
2. WHERE SURFACE AND/OR SHALLOW SUBSURFACE FLOW IS DAMAGING SLOPING UPLAND.
3. WHERE THE SLOPE LENGTH NEEDS TO BE REDUCED TO MINIMIZE SOIL LOSS.

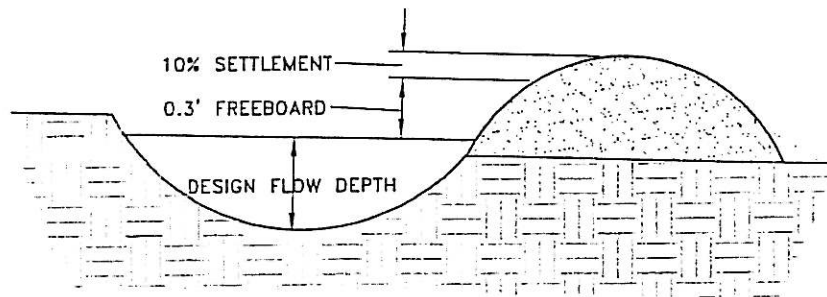

TYPICAL PARABOLIC DIVERSION

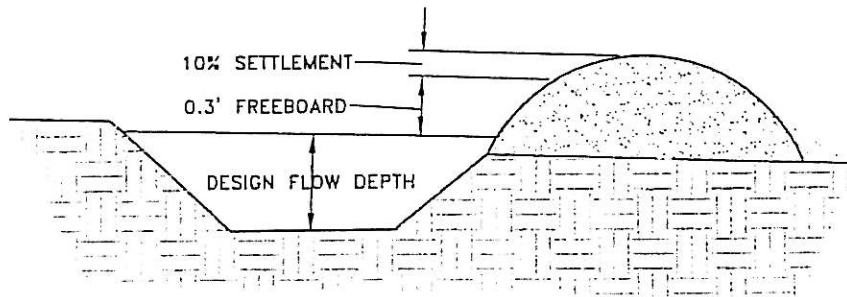

TYPICAL TRAPEZOIDAL DIVERSION

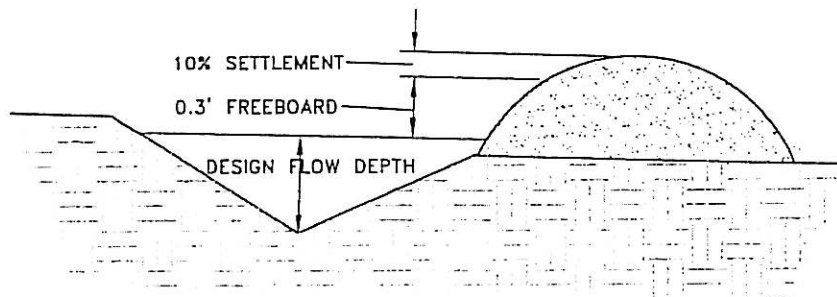

TYPICAL VEE-SHAPED DIVERSION

DIVERSIONS

Exhibit 1100-25

(Source: Virginia Erosion and Sediment Control Handbook)

1105.6 Temporary Diversion Berm (Exhibit 1100-26)

Definition

A temporary ridge of compacted soil located at the top or base of a sloping disturbed area.

Objective

The objective of a temporary diversion berm is to:

- Soil stabilization
- Sediment Control
- Tracking Control
- Wind Erosion Control

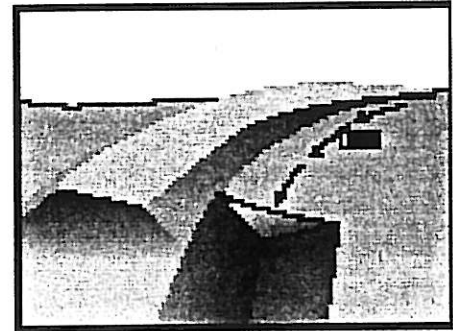

Purpose

The purpose of a diversion berm is to divert storm runoff from higher drainage areas away from unprotected slopes to a stabilized outlet.

Another purpose of a diversion berm is to divert sediment-laden runoff from a disturbed area to a sediment trapping facility.

Application

Temporary diversion berms are used where:

1. Wherever stormwater runoff must be temporarily diverted to protect disturbed slopes.
2. Wherever stormwater runoff must be temporarily diverted to retain sediments on site during construction.

Planning Considerations

A temporary diversion berm is intended to divert overland sheet flow to a stabilized outlet or a sediment trapping facility during establishment of permanent stabilization on sloping disturbed areas. When used at the top of a slope, the structure protects exposed slopes by keeping upland runoff away. When used at the base of a slope, the structure protects adjacent and downstream areas by diverting sediment-laden runoff to a sediment trapping facility.

If the berm is going to remain in place for longer than 15 days, it is very important that it be stabilized with temporary or permanent vegetation. The slope behind the berm is also an important consideration. The berm must have a positive grade to assure drainage, but if the slope is too great, precautions must be taken to prevent erosion due to high velocity flow behind the berm.

This practice is considered an economical one because it uses material available on the site and can usually be constructed with equipment needed for site grading. As specified herein, this practice is intended to be temporary.

Design Criteria

1. No formal design is required.
2. The maximum allowable drainage area is 5 acres.
3. The minimum allowable height measured from the upslope side of the berm is 18 inches.
4. Side slopes shall be 1.5:1 or flatter with a minimum base width of 4.5 feet.
5. The channel behind the dike shall have a positive grade to a stabilized outlet. If the channel slope is less than or equal to 2%, no stabilization is required. If the slope is greater than 2%, the channel shall be stabilized.
6. The diverted runoff if free of sediment must be released through a stabilized outlet or channel.
7. A sediment laden runoff must be diverted and released through a sediment trapping facility.

Construction Specifications

1. Whenever possible, the berm should be built before construction begins on the project.
2. The berm should be adequately compacted to prevent failure.
3. Temporary or permanent seeding and mulch shall be applied to the berm within 15 days of construction.
4. The berm should be located to minimize damages by construction operations and traffic.

Maintenance

This measure shall be inspected after every storm and repairs made to the dike, flow channel and outlet, as necessary. Approximately once every week, whether a storm has occurred or not, the measure shall be inspected and repairs made if needed. Damages caused by construction traffic or other activity must be repaired before the end of each working day.

GENERAL NOTES

DEFINITION – A TEMPORARY RIDGE OF COMPACTED SOIL LOCATED AT THE TOP OR BASE OF A SLOPING DISTURBED AREA.

- PURPOSES –
1. TO DIVERT STORM RUNOFF FROM HIGHER DRAINAGE AREAS AWAY FROM UNPROTECTED SLOPES TO A STABILIZED OUTLET;
 2. TO DIVERT SEDIMENT-LADEN RUNOFF FROM A DISTURBED AREA TO A SEDIMENT TRAPPING FACILITY.

CONDITIONS WHERE PRACTICE APPLIES – WHEREVER STORMWATER RUNOFF MUST BE TEMPORARILY DIVERTED TO PROTECT DISTURBED SLOPES OR RETAIN SEDIMENTS ON SITE DURING CONSTRUCTION. THESE STRUCTURES GENERALLY HAVE A LIFE EXPECTANCY OF 18 MONTHS OR LESS.

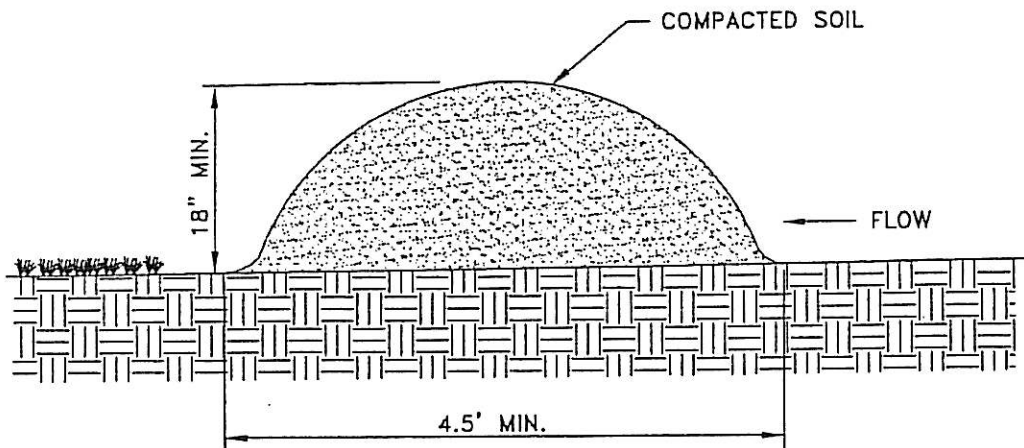

Exhibit 1100-25

(Source: Virginia Erosion and Sediment Control Handbook)

1105.7 Temporary Sediment Trap (Exhibit 1100-26 and 1100-30)

Definition

A temporary sediment trap is a small temporary ponding area, formed by constructing an earthen embankment with a gravel outlet, across a drainage swale.

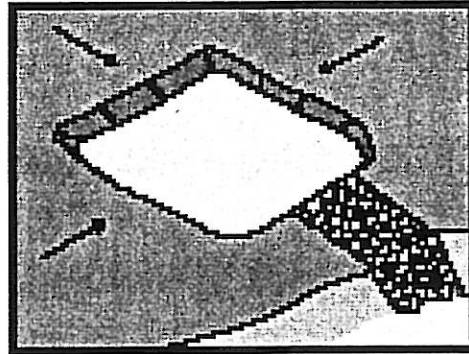

Objective

The objective of a temporary sediment trap is to:

- Soil stabilization
- Sediment Control
- Tracking Control
- Wind Erosion Control

Purpose

The purpose of a temporary sediment trap is to detain sediment laden runoff from small disturbed areas long enough to allow the majority of the sediment to settle out.

Application

Temporary sediment traps should be utilized below drainage areas of 5 acres or less, where the sediment trap will be used no longer than 18 months. The sediment trap may be constructed either independently or in conjunction with a temporary diversion berm.

Planning Considerations

Temporary sediment traps should only be used for small drainage areas. If the contributing drainage area is greater than 5 acres, than the designer should consider a sediment pond. Sediment must be periodically removed from the trap, which should be addressed in the plans or specifications. Sediment traps shall be installed before any land disturbance takes place in the drainage area.

Design Criteria

A. Capacity

The sediment trap must have an initial storage volume of 67 cubic yards per acre of drainage area, measured from the low point of the ground to the crest of the gravel outlet. Sediment should be removed from the trap when the volume is reduced by one-half.

For a natural basin, the volume may be approximated as follows:

$$V = 0.4 \times A \times D$$

where,

- V = the storage volume in cubic foot
- A = the surface area of the flooded area at the crest of the outlet , square feet
- D = the maximum depth, measured from the low point in the trap to the crest of the outlet, in ft.

Excavation

If excavation is necessary to attain the required storage volume, side slopes should be no steeper than 2:1.

Outlet

The outlet for the sediment trap shall consist of a crushed stone section of the embankment located at the low point in the basin. The minimum length of the outlet shall be 6 feet times the acreage of the drainage area. The crest of the outlet must be at least 1.0 foot below the top of the embankment, to insure that the flow will travel over the stone and not the embankment. The outlet shall be constructed on crushed stone.

Embankment Cross-Section

The maximum height of the sediment trap embankment shall be 5 feet as measured from the low point. Minimum top widths (W) and outlet heights (H) for various embankment heights (H) are show in Exhibits 1100-20 and 1100-21.

Removal

Sediment traps must be removed after the contributing drainage area is stabilized. Plans should show how the site of the sediment trap is to be graded and stabilized after removal.

Construction Specifications

1. The area under the embankment shall be cleared, grubbed, and stripped of any vegetation and root mat. To facilitate cleanout, the pool area should be cleared.
2. Fill material for the embankment shall be free of roots or other woody vegetation, organic material, large stones, and other objectionable material. The embankment should be compacted in 8 inch layers by traversing with construction equipment.
3. The earthen embankment shall be seeded with temporary or permanent vegetation within 15 days of construction.
4. Construction operations shall be carried out in such a manner that erosion and water pollution are minimized.
5. The structure shall be removed and the area stabilized when the upslope drainage area has been stabilized.

6. All cut and fill slopes shall be 2:1 or flatter.

Maintenance

1. Sediment shall be removed and the trap restored to its original dimensions when the sediment has accumulated to ½ the design volume of the trap. Sediment removed from the basin shall be deposited in a suitable area and in such a manner that it will not erode.
2. The structure should be checked regularly to insure that it is structurally sound and has not been damaged by erosion or construction equipment. The height of the outlet should be checked to insure that its center is at least one foot below the top of the embankment.

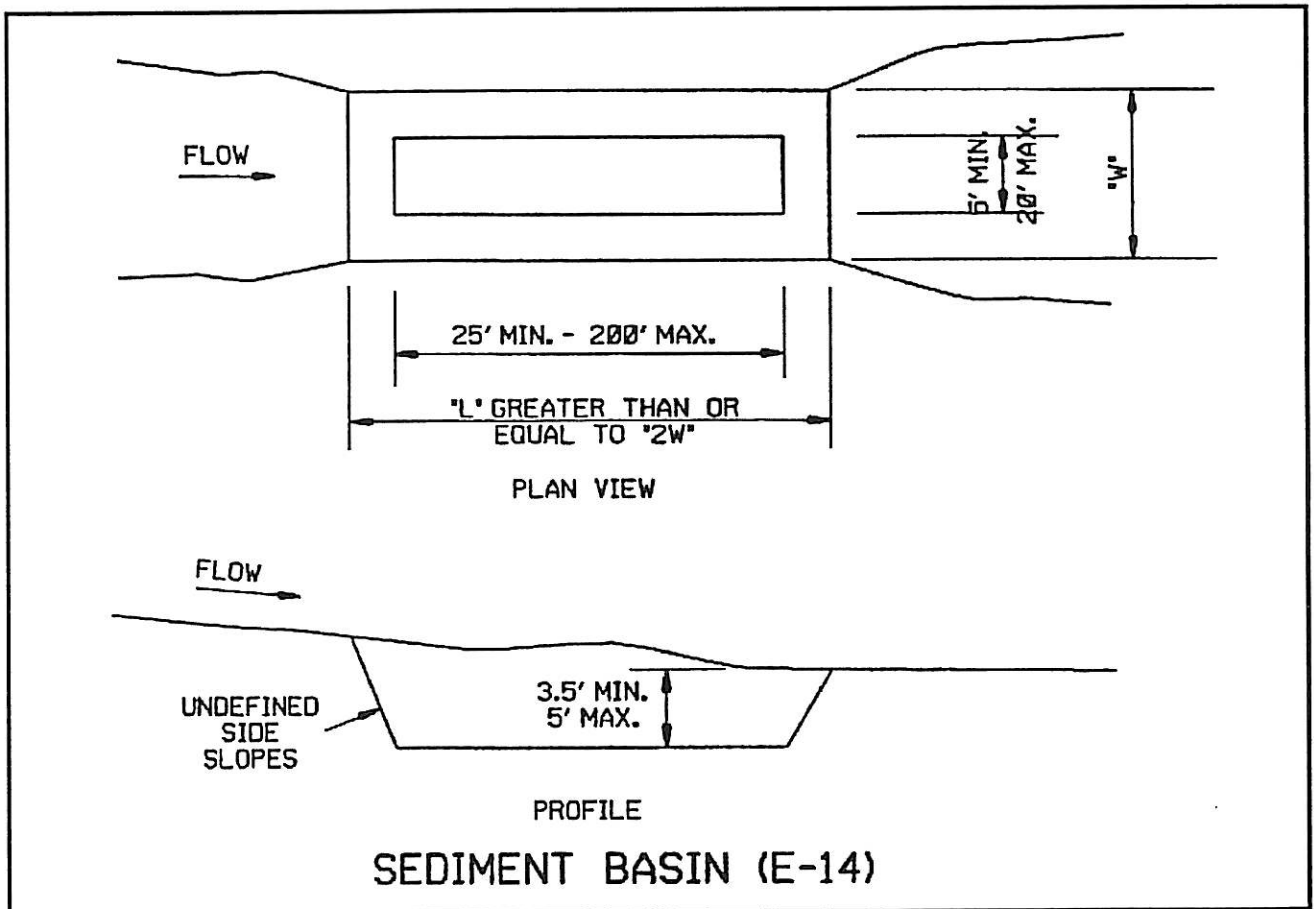

Exhibit 1100-26

(Source: Arkansas Highway and Transportation Department Drainage Manual)

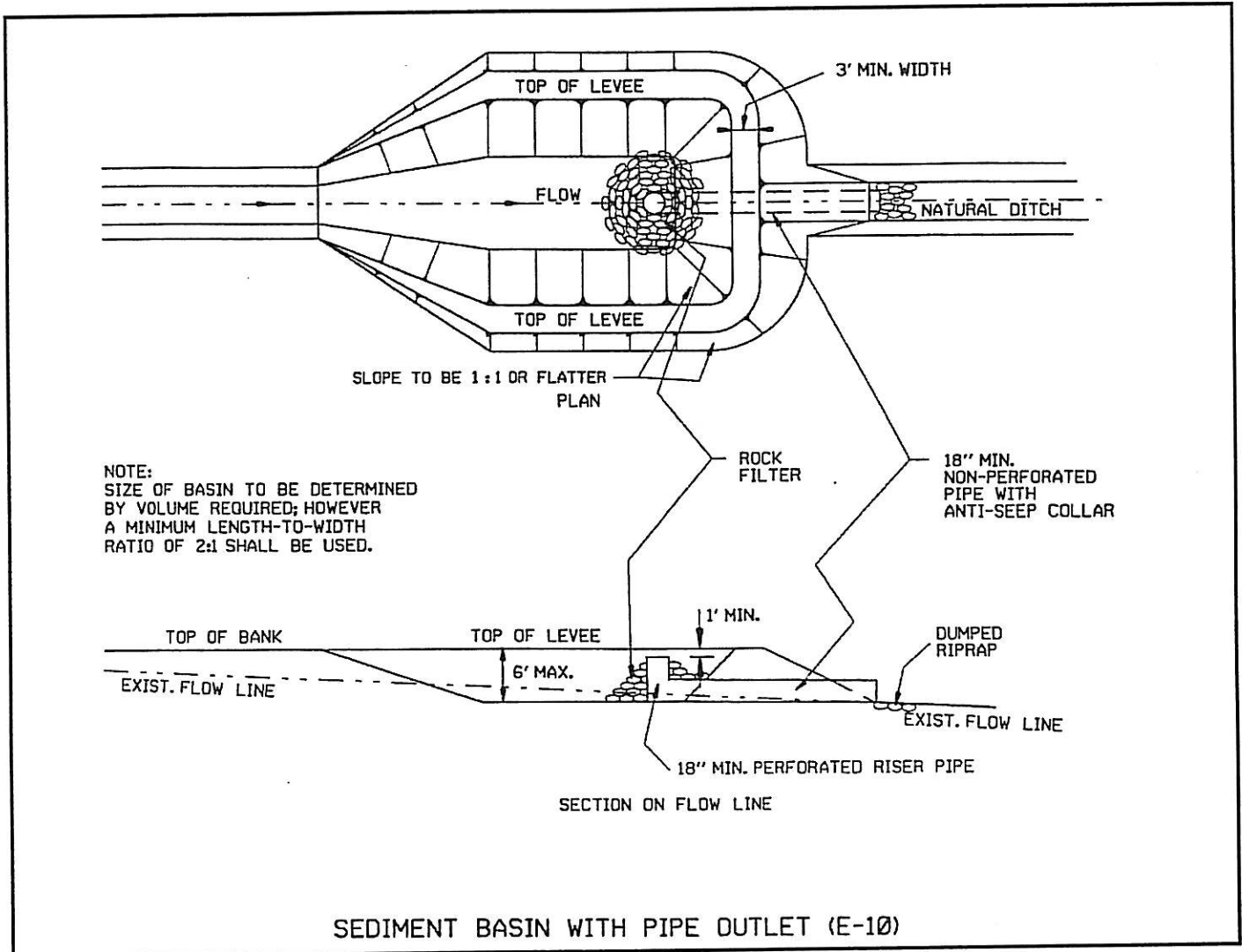

Exhibit 1100-27

(Source: Arkansas Highway and Transportation Department Drainage Manual)

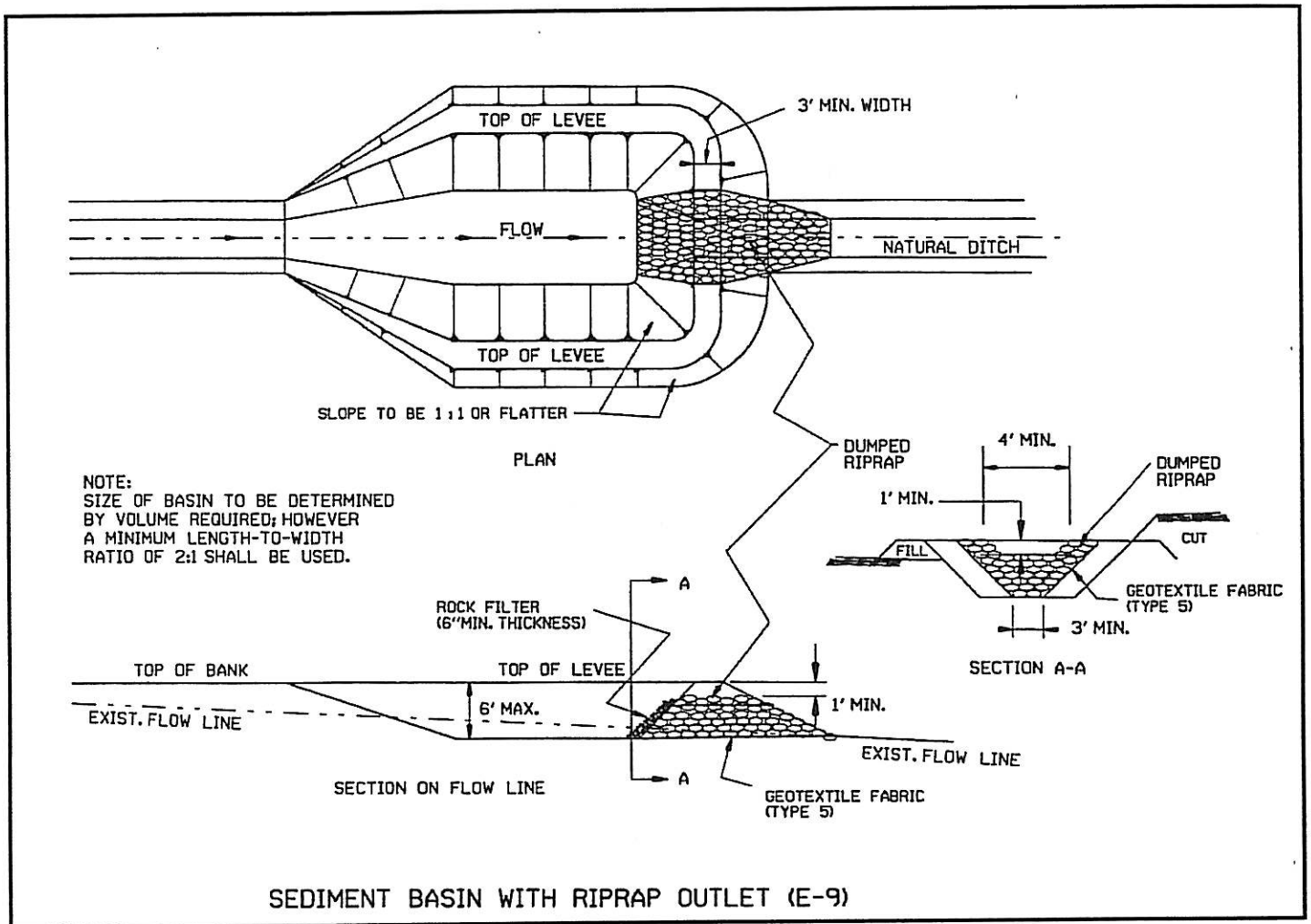
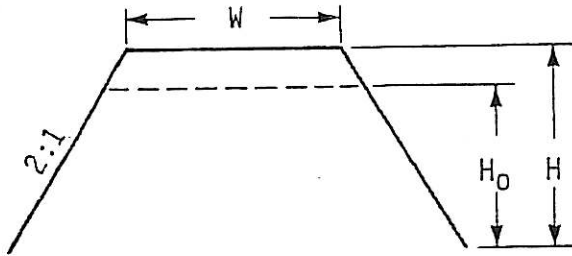

Exhibit 1100-28

(Source: Arkansas Highway and Transportation Department Drainage Manual)

MINIMUM TOP WIDTH (W) REQUIRED FOR SEDIMENT TRAP EMBANKMENTS
ACCORDING TO HEIGHT OF EMBANKMENT (feet)



H	H ₀	W
1.5	0.5	2.0
2.0	1.0	2.0
2.5	1.5	2.5
3.0	2.0	2.5
3.5	2.5	3.0
4.0	3.0	3.0
4.5	3.5	4.0
5.0	4.0	4.5

TEMPORARY SEDIMENT TRAP

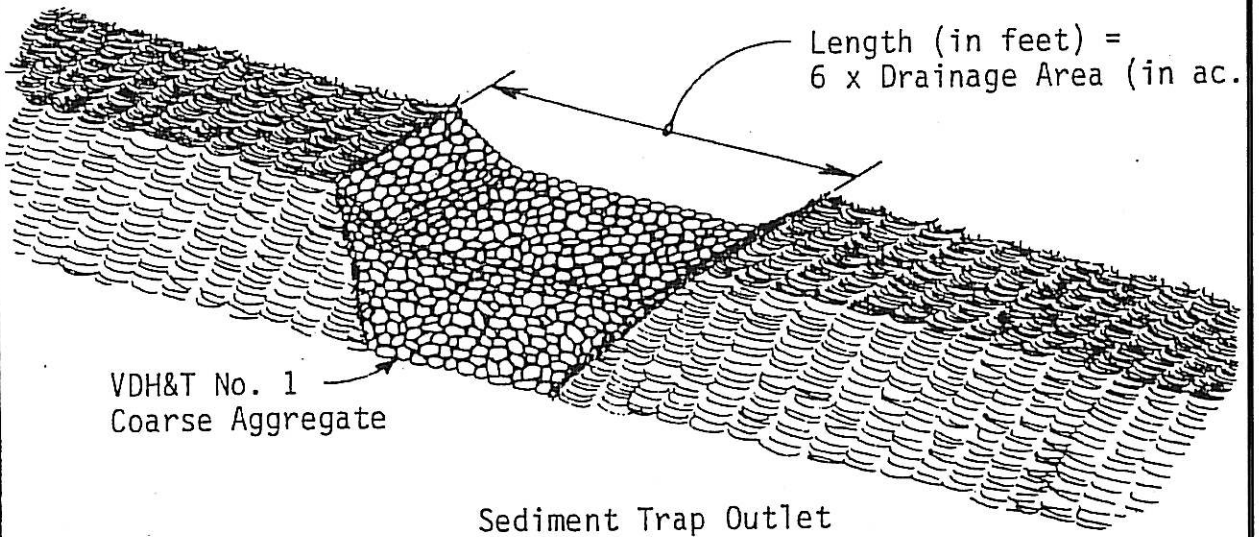
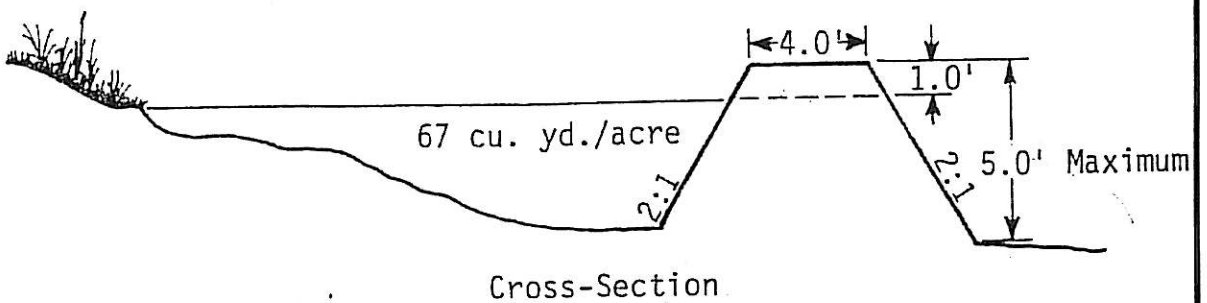

Exhibit 1100-29

(Source: Virginia Erosion and Sediment Control Handbook)

MIS

DEFINITION - A SMALL TEMPORARY PONDING AREA, FORMED BY CONSTRUCTING AN EARTHEN EMBANKMENT WITH A GRAVEL OUTLET, ACROSS A DRAINAGE SWALE.

PURPOSE - TO DETAIN SEDIMENT-LADEN RUNOFF FROM SMALL DISTURBED AREAS LONG ENOUGH TO ALLOW THE MAJORITY OF THE SEDIMENT TO SETTLE OUT.

CONDITIONS WHERE PRACTICE APPLIES -
 1. BELOW DRAINAGE AREAS OF 3 ACRES OR LESS.
 2. WHERE THE SEDIMENT TRAP WILL BE USED NO LONGER THAN 18 MONTHS. (THE MAXIMUM USEFUL LIFE IS 18 MONTHS)
 3. THE SEDIMENT TRAP MAY BE CONSTRUCTED EITHER INDEPENDENTLY OR IN CONJUNCTION WITH A TEMPORARY DIVERSION DISE (STD. & SPEC. 1.15).

REMOVAL - SEDIMENT TRAPS MUST BE REMOVED AFTER THE CONTRIBUTING DRAINAGE AREA IS STABILIZED. SITE MUST BE GRADED AND STABILIZED AFTER REMOVAL.

- FILL MATERIAL FOR THE EMBANKMENT SHALL BE FREE OF ROOTS, LARGE STONES OR OTHER OBJECTIONABLE MATERIAL.

- THE EMBANKMENT SHALL BE COMPACTED IN 8 INCH LAYERS BY TRAVERSING WITH CONSTRUCTION EQUIPMENT.

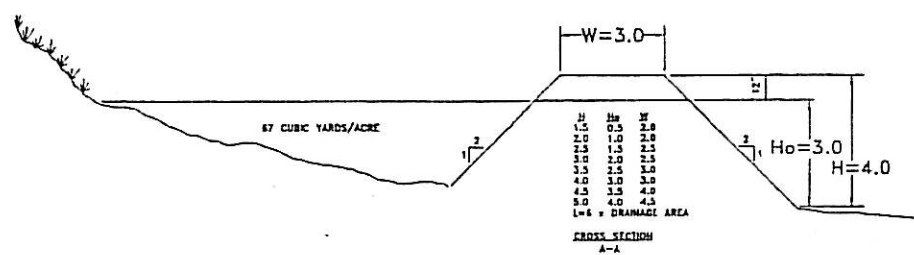
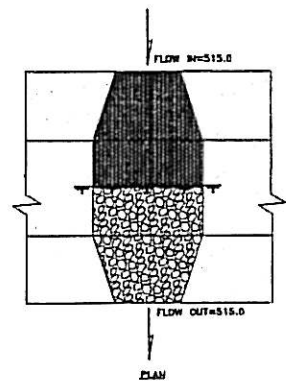
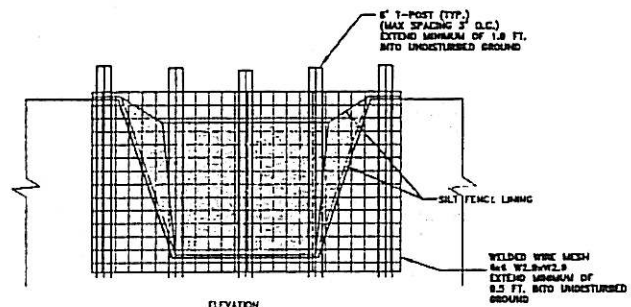
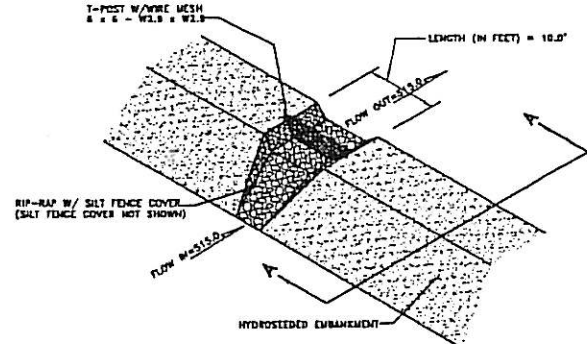
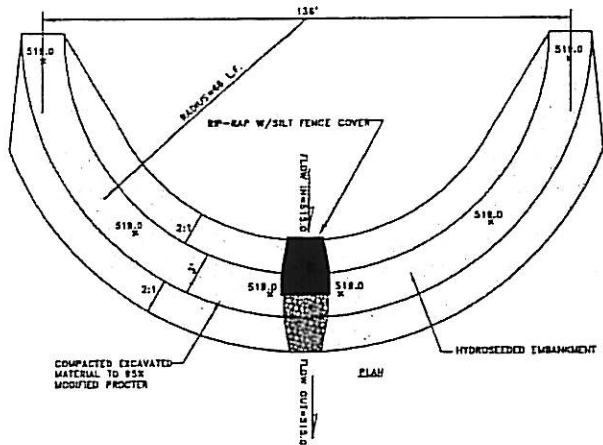
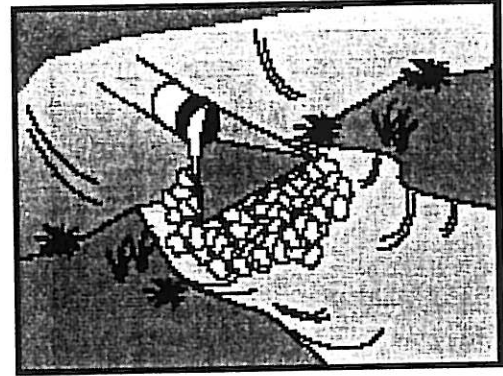

Exhibit 1100-30

1105.8 Riprap

Definition

A layer of loose rock or aggregate placed over an erodible soil surface.



Objective

The objective of rip rap is to:

- Soil stabilization
- Sediment Control
- Tracking Control
- Wind Erosion Control

Purpose

The purpose of riprap is to protect the soil surface from the erosive forces of water.

Application

This practice applies to soil-water interfaces where the soil conditions, water turbulence and velocity, expected vegetative cover, and groundwater conditions are such that the soil may erode under the design flow conditions. Riprap may be used, as appropriate, at such places as storm drain outlets, channel banks and/or bottoms, roadside ditches, drop structures, and shorelines. Broken concrete is not suitable as riprap.

These devices may be used at the following locations:

- A. Outlets of pipes, drains, culverts, slope drains, diversion ditches, swales, conduits or channels.
- B. Outlets located at the bottom of mild to steep slopes.
- C. Discharge outlets that carry continuous flows of water.
- D. Outlets subject to short, intense flows of water, such as flash floods.
- E. Points where lined conveyances discharge to unlined conveyances.

Construction Specifications

There are many types of energy dissipater's, with rock being one of them.

- A. Install riprap, grouted riprap, or concrete apron at selected outlet. Riprap aprons are best suited for temporary use during construction.
- B. Carefully place riprap to avoid damaging the filter fabric.

- C. Align apron with receiving stream and keep straight throughout its length. If a curve is needed to fit site conditions, place it in upper section of apron.
- D. If size of apron riprap is large, protect underlying filter fabric with a gravel blanket
- E. Outlets on slopes steeper than 10 percent shall have additional protection.

Maintenance

- A. Inspect temporary measures prior to the rainy season, after rainfall events, and regularly (approximately once per week) during the rainy season.
- B. Inspect apron for displacement of the riprap and/or damage to the underlying fabric. Repair fabric and replace riprap which has washed away.
- C. Inspect for scour beneath the riprap and around the outlet. Repair damage to slopes or underlying filter fabric immediately.
- D. Temporary devices shall be completely removed as soon as the surrounding drainage area has been stabilized, or at the completion of construction.

1105.9 Seeding

Definition

Seeding is the application of lime, fertilizer, seed, mulch cover and water on graded areas in order to deter erosion.

Purpose

The purpose of seeding is to stabilize the soil, reduce damage from sediment and runoff to downstream areas, improve wildlife habitat, and enhance beauty of the area.

Application

Seeding is used on sediment-producing erodible areas, such as dikes, levees, cuts, fills, and gullied areas.

Design Criteria

Refer to Section 620 of AHTD Standard Specifications for Highway Construction for material and construction requirements.

1105.10 Hydroseeding

Definition

Hydroseeding typically consists of applying a mixture of fiber, seed, fertilizer, and stabilizing emulsion with hydro-mulch equipment, which temporarily protects exposed soils from erosion by water and wind. This is one of five temporary soil stabilization alternatives to consider.

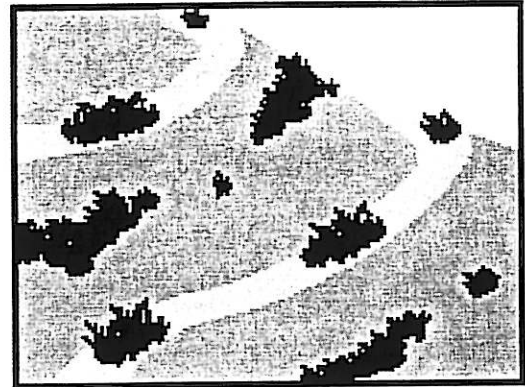

Objective

The objective of rip rap is to:

- Soil stabilization
- Sediment Control
- Tracking Control
- Wind Erosion Control

Purpose

The purpose of hydroseeding is to stabilize the soil, reduce damage from sediment and runoff to downstream areas, improve wildlife habitat, and enhance beauty of the area.

Application

Hydroseeding is applied on disturbed areas requiring temporary protection until permanent vegetation is established, or disturbed areas that must be redisturbed following an extended period of inactivity.

Construction Specifications

The following steps shall be followed for implementation of hydroseeding:

- A. Refer to Section 620 of AHTD Standard Specifications for Highway Construction for seed mix.
- B. Avoid use of hydroseeding in areas where the best management practice (BMP) would be incompatible with future earthwork activities and would have to be removed.
- C. Hydroseeding can be accomplished using a multiple-step or one-step process. The multiple-step process ensures maximum direct contact of the seeds to soil. When the one-step process is used to apply the mixture of fiber, seed, etc., the seed rate shall be increased to compensate for all seeds not having direct contact with the soil.
- D. Prior to application, roughen the slope, fill area, or area to be seeded with the furrows trending along the contours.

- E. Apply a straw mulch to keep seeds in place and to moderate soil moisture and temperature until the seeds germinate and grow.
- F. Follow-up applications shall be made as needed to cover weak spots, and to maintain adequate soil protection.
- G. Avoid over-spray onto the travel way, sidewalks, lined drainage channels and existing vegetation.

Maintenance

- A. All seeded areas shall be inspected for failures and re-seeded, fertilized, and mulched within the planting season, using not less than half the original application rates. Any temporary revegetation efforts that do not provide adequate cover must be revegetated.
- B. After any rainfall event, the Contractor is responsible for maintaining all slopes to prevent erosion.

1105.11 Hydraulic Mulch

Definition

Hydraulic mulch consists of applying a mixture of shredded wood fiber or a hydraulic matrix, and a stabilizing emulsion or tackifier with hydro-mulching equipment. This will protect exposed soil from erosion by raindrop impact or wind. This is one of five temporary soil stabilization alternatives to consider.

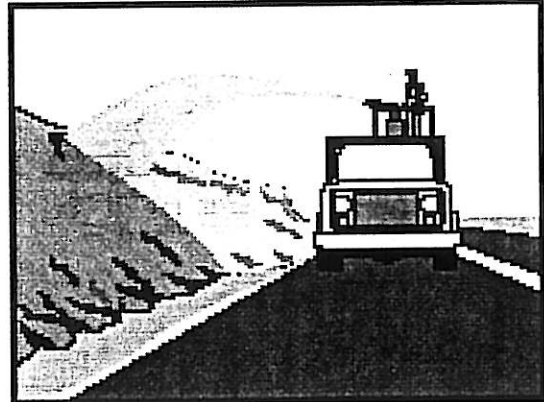

Objective

The objective of hydraulic mulch is to:

- Soil stabilization
- Sediment Control
- Tracking Control
- Wind Erosion Control

Purpose

The purpose of hydraulic mulching is to stabilize the soil, reduce damage from sediment and runoff to downstream areas, improve wildlife habitat, and enhance beauty of the area.

Application

- A. Hydraulic mulch is applied to disturbed areas requiring temporary protection until permanent vegetation is established or disturbed areas that must re-disturbed following an extended period of inactivity.
- B. Avoid use in areas where the mulch would be incompatible with immediate earthwork activities and would have to be removed.

Maintenance

- A. Maintain an unbroken, temporary mulched ground cover throughout the period of construction the soils are not being reworked. Inspect before expected rain storms and repair any damaged ground cover and re-mulch exposed areas of bare soil.
- B. After any rainfall event, the Contractor is responsible for maintaining all slopes to prevent erosion.

1105.12 Slope Drains

Definition

A slope drain is a pipe used to intercept and direct surface runoff or groundwater into a stabilized watercourse, trapping device or stabilized area. Slope drains are used with lined ditches to intercept and direct surface flow away from slope areas to protect cut or fill slopes.

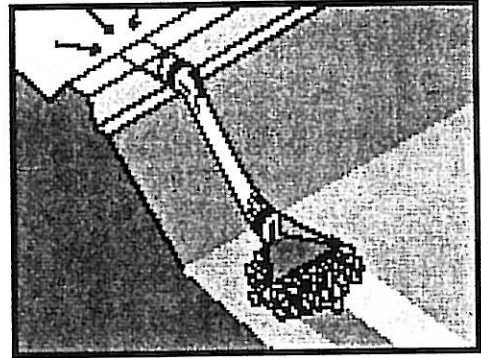

Objective

The objective of a slope drain is to:

- Soil stabilization
- Sediment Control
- Tracking Control
- Wind Erosion Control

Purpose

The purpose of a slope drain is to keep clean water clean. A slope drain moves clean water from a higher location to a lower location without eroding a slope and creating unnecessary sediment. A slope drain helps reduce damage from sediment and runoff to downstream areas, improve wildlife habitat, and enhance beauty of the area.

Application

Slope drains may be used at construction sites where slopes may be eroded by surface runoff.

Design Criteria

- A. When using slope drains, limit drainage area to 10 ac per pipe. For larger areas, use a rock-lined channel or a series of pipes.
- B. Maximum slope generally limited to 1:2 (V:H), as energy dissipation below steeper slopes is difficult.
- C. Direct surface runoff to slope drains with interceptor dikes. “Earth Dikes/Drainage Swales, and Lined Ditches”.
- D. Slope drains can be placed on or buried underneath the slope surface.
- E. Recommended materials are PVC, ABS, or comparable pipe.

When installing slope drains:

- A. Install slope drains perpendicular to slope contours.
- B. Compact soil around and under entrance, outlet, and along length of pipe.
- C. Securely anchor and stabilize pipe and appurtenances into soil.
- D. Check to ensure that pipe connections are water tight.
- E. Protect area around inlet with filter cloth. Protect outlet with riprap or other energy dissipation device. For high energy discharges, reinforce riprap with concrete or use reinforced concrete device.
- F. Protect inlet and outlet of slope drains: use standard flared end section at entrance for pipe slope drains 12inches and larger.

Maintenance

- A. Inspect before and after each rain storm, and twice monthly until the tributary drainage area has been stabilized. Follow routine inspection procedures for inlets thereafter.
- B. Inspect outlet for erosion and downstream scour. If eroded, repair damage and install additional energy dissipation measures. If downstream scour is occurring, it may be necessary to reduce flows being discharged into the channel unless other preventative measures are implemented.
- C. Inspect slope drainage for accumulations of debris and sediment.
- D. Remove built-up sediment from entrances and outlets as required. Flush drains if necessary; capture and settle out sediment from discharge.
- E. Make sure water is not ponding onto inappropriate areas (e.g., active traffic lanes, material storage areas, etc.).

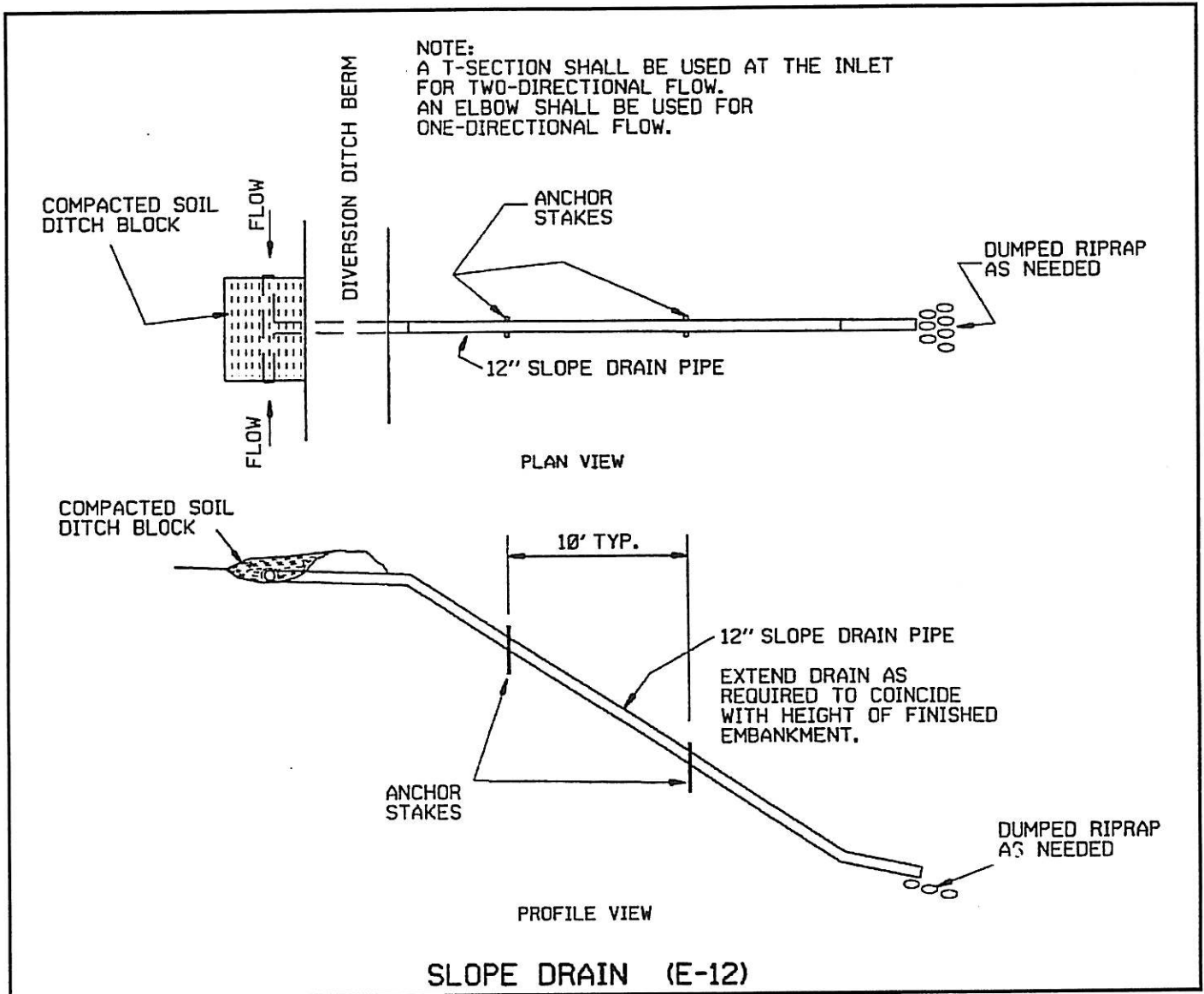

Exhibit 1100-31

(Source: Arkansas Highway and Transportation Department Drainage Manual)

1105.13 Scheduling

Definition

Scheduling involves developing, for every project, a schedule that includes sequencing of construction activities with the implementation of construction site BMPs such as temporary soil stabilization (erosion control) and temporary sediment controls measures. The purpose is to reduce the amount and duration of soil exposed to erosion by wind, rain, runoff and vehicle tracking, and to perform the construction activities and control practices in accordance with the planned schedule.

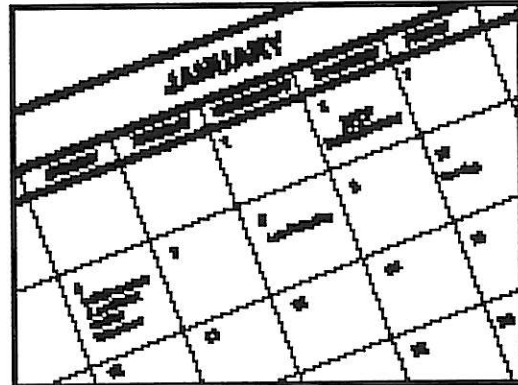

Objective

The objective of scheduling is to:

- Soil stabilization
- Sediment Control
- Tracking Control
- Wind Erosion Control

Purpose

The purpose of hydraulic mulching is to stabilize the soil, reduce damage from sediment and runoff to downstream areas, improve wildlife habitat, and enhance beauty of the area.

Application

- A. Construction sequencing shall be scheduled to minimize land disturbance for all projects during the rainy season.

Construction Specifications

- A. Plan the project and develop a schedule or to layout the construction plan. The schedule shall clearly show how the rainy season relates to soil disturbing and re-stabilization activities. The construction schedule shall be incorporated into the SWPPP.
- B. The schedule shall include detail on the rainy season implementation and deployment of:
1. temporary soil stabilization BMPs,
 2. temporary sediment control BMPs,
 3. tracking control BMPs,
 4. wind erosion control BMPs,

- C. Scheduling shall also include dates for significant long-term operations or activities that may have planned non-storm water discharges such as dewatering, sawcutting, grinding, drilling, boring, crushing, blasting, painting, hydro-demolition, mortar mixing, bridge cleaning, etc.
- D. Schedule work to minimize soil disturbing activities during the rainy season.
- E. Work out the sequencing and timetable for the start and completion of each item such as site clearing and grubbing, grading, excavation, paving, pouring foundations, installing utilities, etc., to minimize the active construction area during the rainy season.
- F. Schedule major grading operations for the non-rainy season when practical.
- G. Stabilize non-active areas as soon as practical.
- H. Monitor the weather forecast for rainfall.
- I. When rainfall is predicted, adjust the construction schedule to allow the implementation of soil stabilization and sediment controls and sediment treatment controls on all disturbed areas prior to the onset of rain.
- J. Be prepared year-round to deploy soil stabilization and sediment control and sediment treatment control practices as required by this Manual. Erosion may be caused during dry seasons by unseasonal rainfall, wind and vehicle tracking. Keep the site stabilized year-round, and retain and maintain rainy season sediment trapping devices in operational condition.
- K. Sequence trenching activities so that most open portions are closed before new trenching begins.
- L. Incorporate staged seeding and re-vegetation of graded slopes as work progresses.
- M. Consider scheduling when establishing permanent vegetation (appropriate planting time for specified vegetation).
- N. Apply permanent erosion control to areas deemed substantially complete during the project's defined seeding window.

Maintenance

- A. Verify that work is progressing in accordance with the schedule. If progress deviates, take corrective actions.

1105.14 Preservation of Existing Vegetation

Definition

Preservation of existing vegetation is the identification and protection of desirable vegetation that provides erosion and sediment control benefits.

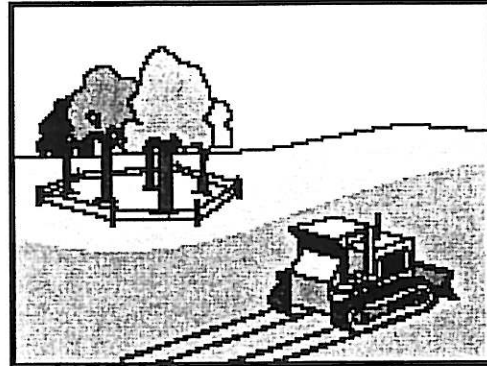

Objective

The objective of preservation of existing vegetation:

- Soil stabilization
- Sediment Control
- Tracking Control
- Wind Erosion Control

Purpose

The purpose of preserving existing vegetation is to minimize disturbance of sensitive areas and minimize erosion. Preservation of existing vegetation reduces damage from sediment and runoff to downstream areas, improve wildlife habitat, and enhance beauty of the area.

Application

A. Timing

1. Preservation of existing vegetation shall be provided prior to the commencement of clearing and grubbing operations or other soil-disturbing activities in areas where no construction activity is planned or will occur at a later date.
2. Preservation of existing vegetation shall conform to scheduling requirements set forth in the special provisions.

B. Design and Layout

1. Mark areas to be preserved with temporary fencing made of orange polypropylene that is stabilized against ultraviolet light. The temporary fencing shall be at least one meter wide and shall have openings not larger than 50mm by 50mm.
2. Fence posts shall be either wood or metal, at the Contractor's discretion, as appropriate for the intended purpose. The post spacing and depth shall be adequate to completely support the fence in an upright position.
3. Minimize the disturbed areas by locating temporary roadways to avoid stands of trees and shrubs and to follow existing contours to reduce cutting and filling.

4. Consider the impact of grade changes to existing vegetation and the root zone.

C. Installation

1. Construction materials, equipment storage, and parking areas shall be located where they will not cause root compaction.
2. Keep equipment away from trees to prevent trunk and root damage.
3. Maintain existing irrigation systems.
4. Employees and subcontractors shall be instructed to honor protective devices. No heavy equipment, vehicular traffic, or storage piles of any construction materials shall be permitted within the drip line of any tree to be retained. Removed trees shall not be felled, pushed, or pulled into any retained trees. Fires shall not be permitted within 100 ft of the drip line of any retained trees. Any fires shall be of limited size, and shall be kept under continual surveillance. No toxic or construction materials - including paint, acid, nails, gypsum board, chemicals, fuels, and lubricants - shall be stored within 50 ft of the drip line of any retained trees, nor disposed of in any way which would injure vegetation.

D. Trenching and Tunneling

1. Trenching shall be as far away from tree trunks as possible, usually outside of the tree drip line or canopy. Curve trenches around trees to avoid large roots or root concentrations. If roots are encountered, consider tunneling under them. When trenching and/or tunneling near or under trees to be retained, tunnels shall be at least 18 inches below the ground surface, and not below the tree center to minimize impact on the roots.
2. Tree roots shall not be left exposed to air; they shall be covered with soil as soon as possible, protected, and kept moistened with wet burlap or peat moss until the tunnel and/or trench can be completed.
3. The ends of damaged or cut roots shall be cut off smoothly.
4. Trenches and tunnels shall be filled as soon as possible. Careful filling and tamping will eliminate air spaces in the soil which can damage roots.
5. Remove any trees intended for retention if those trees are damaged seriously enough to affect their survival. If replacement is desired or required, the new tree shall be of similar species, and of at least 2 inch caliper, unless otherwise required by the contract documents.
6. After all other work is complete, fences and barriers shall be removed last. This is because protected trees may be destroyed by carelessness during the final cleanup and landscaping.

Maintenance

During construction, the limits of disturbance shall remain clearly marked at all times. Irrigation or maintenance of existing vegetation shall conform to the requirements in the landscaping plan. If damage to protected trees still occurs, maintenance guidelines described below shall be followed:

- A. Serious tree injuries shall be attended to by an arborist.
- B. Any damage to the crown, trunk, or root system of a retained tree shall be repaired immediately.
- C. Damaged roots shall be immediately cut clean.
- D. If bark damage occurs, all loosened bark shall be cut back into the undamaged area, with the cut tapered at the top and bottom, and drainage provided at the base of the wood. Cutting of the undamaged area shall be as limited as possible.
- E. Soil which has been compacted over a tree's root zone shall be aerated by punching holes 12 inches deep with an iron bar, and moving the bar back and forth until the soil is loosened. Holes shall be placed 18 inches apart throughout the area of compacted soil under the tree crown.
- F. Stressed or damaged broadleaf trees shall be fertilized to aid recovery.
- G. Trees shall be fertilized in the late fall or early spring.
- H. Fertilizer shall be applied to the soil over the feeder roots and in accordance with label instructions, but never closer than 3 feet to the trunk. The fertilized area shall be increased by one-fourth of the crown area for conifers that have extended root systems.